

The background of the top half of the page is a photograph of a white industrial control cabinet. On the left side of the cabinet, there is a panel with several green indicator lights and various cables. The cabinet door has the 'washlink SYSTEMS' logo in black and blue, with the website 'WASHLINKSYSTEMS.COM' and phone number '866-WASHLINK' printed below it.

washlink
SYSTEMS
WASHLINKSYSTEMS.COM 866-WASHLINK

Washlink Systems

Service Manual

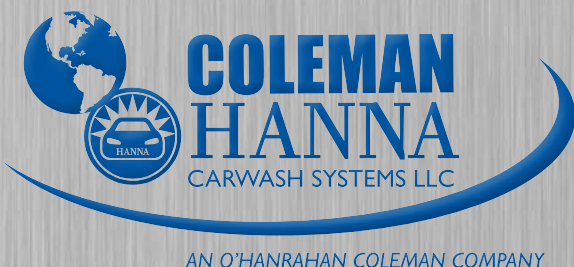

5842 W 34th St, Houston, TX 77092
1.800.999.9878 • 1.713.683.9878
www.colemanhanna.com



Find us on Facebook:
[/ColemanHannaCarwash](https://www.facebook.com/ColemanHannaCarwash)

ACCU-PULSE

Installation Guide

1. Securely mount ACCU-PULSE by conveyor hydraulic unit return (on wall)
2. Remove existing conveyor hydraulic return line
3. Connect existing conveyor hydraulic return line to one port on ACCU-PULSE
4. Connect new hydraulic hose (supplied by customer) to other port on ACCU-PULSE
5. Connect new hydraulic hose to return to hydraulic unit
6. Wire ACCU-PULSE to Car Wash Controller

NOTE: This MUST be installed inline with conveyor motor return only



Mounting holes 3/8"

Mounting holes 3/8"

Motor Ports

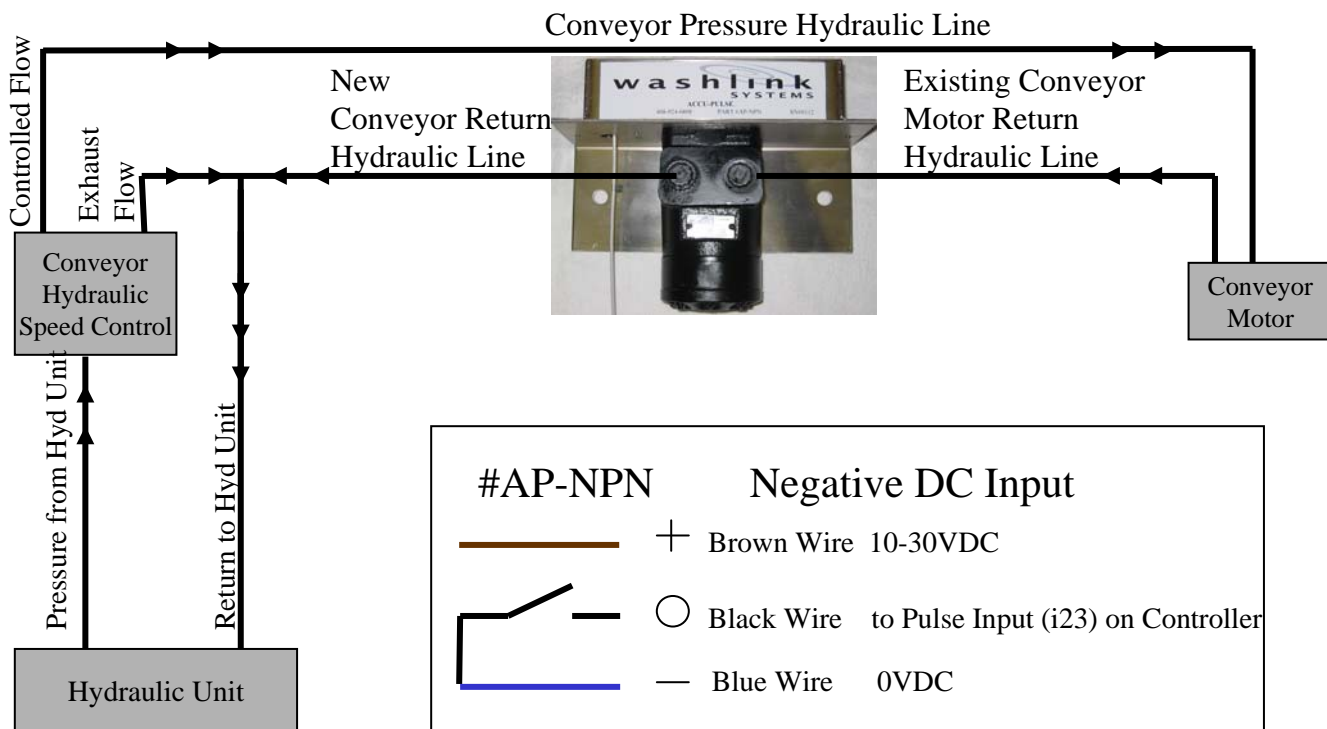



**Express Bay
Controller**

Tech Guide

WASHLINK SYSTEMS

Express Bay Controller

This document provides comprehensive information for using the Express Bay Controller (EBC).

The EXB gives the ability to add pre and post functions to a rollover/automatic car wash. Functions are controlled by package and photo eyes (or any input device)

When emailing or calling for assistance, you must have the following information available:

Location Name: _____

Contact Person: _____

Contact Phone: _____

Distributor Name: _____

COPYRIGHT

2012 Washlink Systems. All rights reserved.

THIS DOCUMENT IS THE EXCLUSIVE PROPERTY OF WASHLINK SYSTEMS AND IS PREPARED ONLY FOR USE BY THE COMPANY PURCHASING THE EQUIPMENT. EDITING, COPYING, DISTRIBUTING, AND/OR SELLING THIS DOCUMENT IS STRICTLY PROHIBITED WITHOUT PRIOR WRITTEN CONSENT FROM WASHLINK SYSTEMS. WASHLINK SYSTEMS RESERVES THE RIGHT TO EDIT THIS DOCUMENT IN ANY MANNER DEEMED NECESSARY, AT ANY TIME, AND WITHOUT PRIOR NOTICE.

Table of Contents

1. Features	3
2. Installation	4
2.1 Power Requirements	4
2.2 Input Requirements	4
2.3 Output Requirements	4
3. Programming	5
3.1 Admin Settings	5
3.2 Input Debounce	6
3.3 Function Setup	7
3.4 Flasher Setup	8
3.5 Package Setup	9
3.6 Max in Stack	10
3.7 Package Group Time	11
3.8 Entrance Door Open.....	12
3.9 Entrance Door Close.....	13
3.10 Exit Door Open	14
3.11 Exit Door Close.....	15
4. Real Time Input Status	16
4.1 Real Time Input Status	16
5. Counters	17
5.1 Input and Output Lifetime Counters	17
6. Stack	18
6.1 View Current Stack	18
7. Clear All	19
7.1 Clear All	19
8. Panel Build Information	20
8.1 Wiring Cover	21
8.1 PLC Wiring	22
8.2 Expansion Module	23
8.3 Ethernet Module	24
8.4 Panel Layout	25

1 Features

Features of Washlink Systems Express Bay Controller:

The ability to assign functions to packages

Entrance & Exit door control with thermostat input

Easy installation

Individual function fuse protection with blown fuse indicator.

Isolation relays on all outputs.

Built in counters for each input.

Built in counters for each output.

Industry proven components from Siemens Worldwide.

Corrosion proof non-metallic enclosure.

Works on ALL brands of car wash equipment and tunnel controllers.

UL Listed and CE compliant.

2 Installation





The Washlink Systems EBC should be mounted securely to a stable and permanent wall. Choose a location in the equipment room that is easily accessible and provides protection from the elements.

2.1 Power Requirements

The Washlink Systems EBC requires 110-230vac (15A max) branch circuit protection for PLC and Output Relay Switched power.

These power circuits is provided by the customer.



These circuits should be connected to **Fuse 101 PLC & Fuse 103 AUX.**

	Warning: All electrical work should be performed by a qualified and licensed electrician. All electrical work should meet or exceed National and Local codes and ordinances.
	Warning: Risk of electrical shock. More than one disconnect may be required to be de-energized before servicing equipment.
	Warning: To reduce the risk of fire, connect only to a 110-230vac circuit provided with 15a maximum branch circuit protection in accordance with the NEC, ANSI/NFPA 70 and local codes.
	Warning: Bonding between conduit connection is not automatic and must be provided as part of the installation.

2.2 Inputs

The EBC Input power is supplied by the PLC.

All inputs are 24vdc normally open.

	Warning: All Inputs are 24vdc. Any other voltage will damage the Controller and void warranty.
	Note: An interface relay may be needed to give the correct input contact type

2.3 Outputs

Each of the EBC outputs have a double pole double throw isolation relay.

Each output relay has a test button as well as a manual override switch.

The green indicator light on each relay will be illuminated when coil power is present.

Each Output has 24vac and 120vac pre wired to fuses.

The devices to be wired to each relay are the responsibility of the customer.

3 Programming

3.1 Administrator Settings

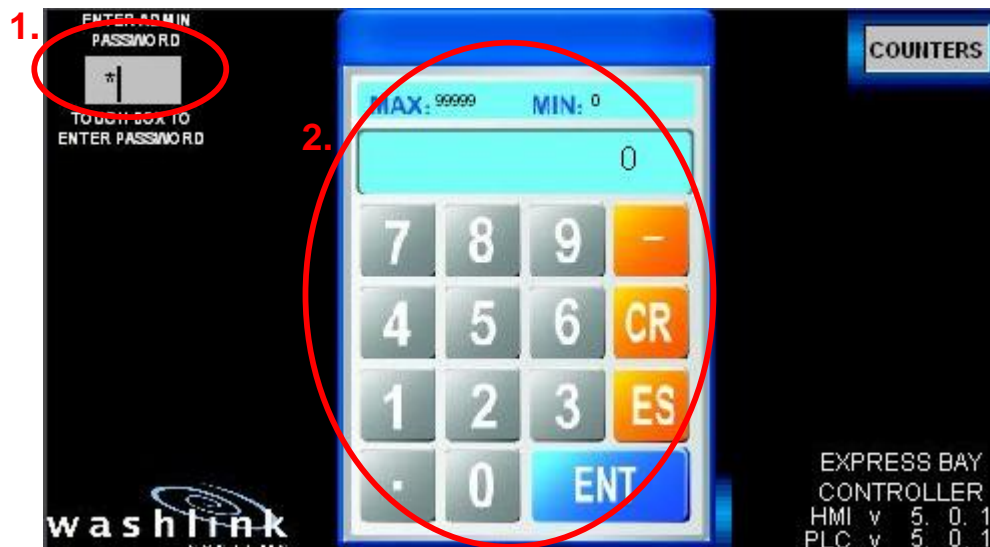

1. From the HOME screen, press the password box.
2. Enter the Admin password and press ENT (default is 95125).
3. The ADMIN SETTINGS button will now appear, press it.
4. You will now have access to the Admin Settings (see following pages)

3 Programming

3.2 Input Debounce

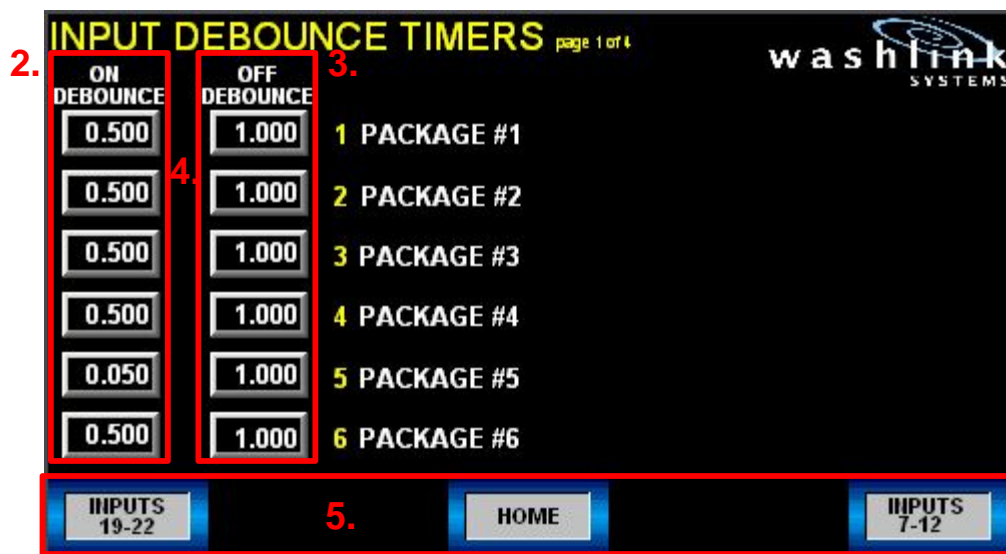
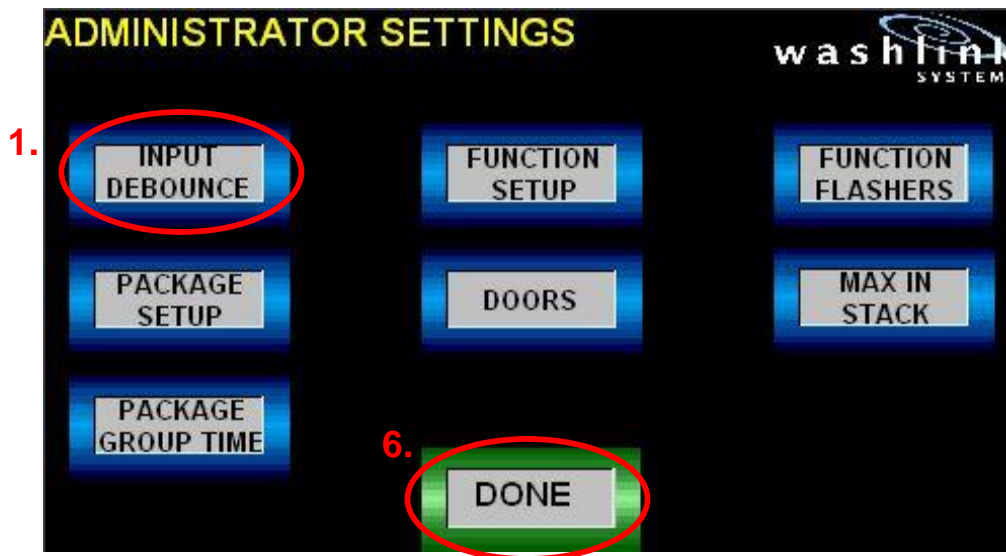

1. From the Administrator Settings page, press INPUT DEBOUNCE.
2. On Debounce, this delays by the amount of time in seconds, until the controller reacts to the input.
3. Off Debounce, this extends the amount of time in seconds the controller thinks the input is activated.
4. On & Off Debounce values in xx.xxx seconds.
5. Press to go to other inputs to adjust or press HOME when finished.
6. Press DONE when finished.

3 Programming

3.3 Function Setup

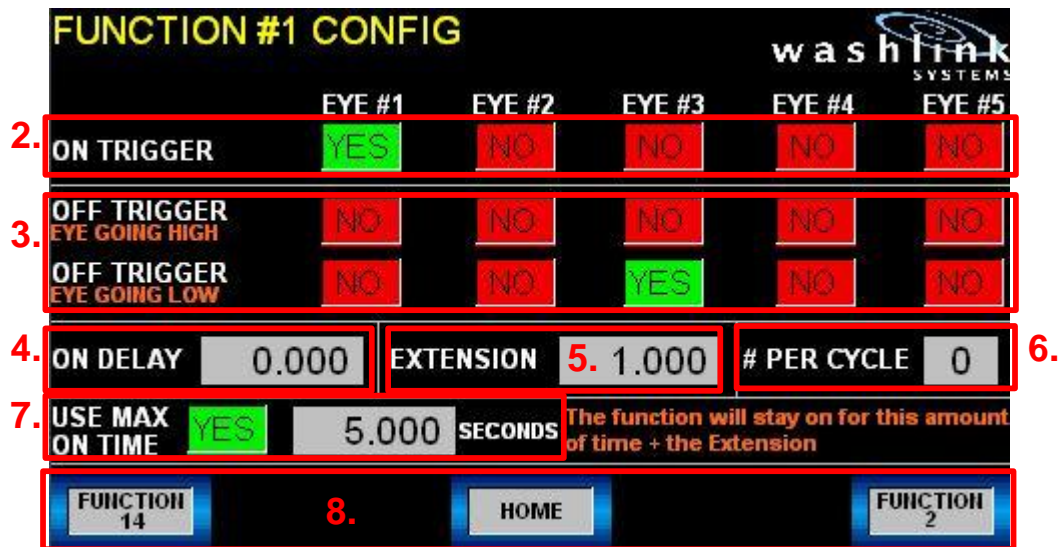
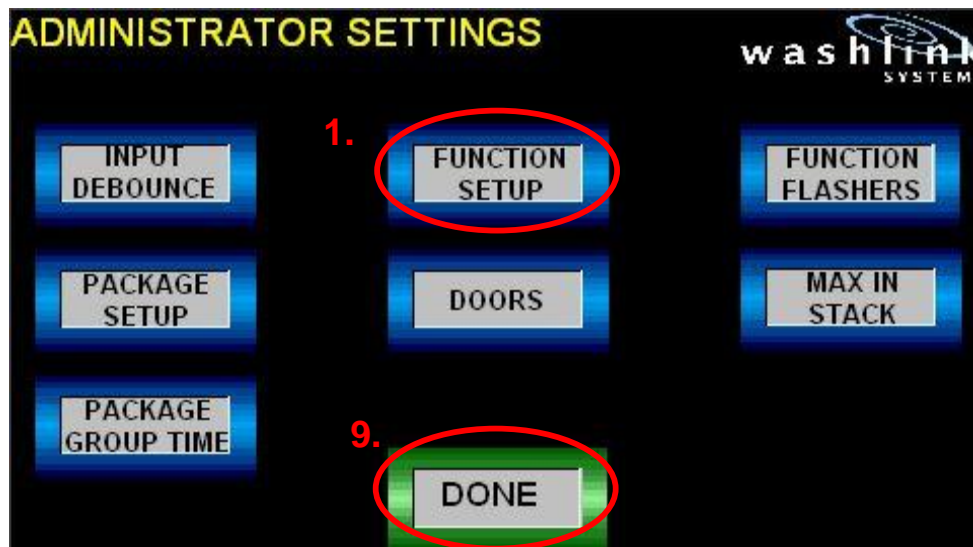

1. From the Administrator Settings page, press FUNCTION SETUP.
2. On Trigger, turn on function based on this eye.
3. Off Trigger, turn off function based on this eye.
4. On Delay, time after on trigger eye is high before function will turn on.
5. Extension, amount of time after the off trigger before function will turn off.
6. # Per Cycle, number of times to allow function to work (if a tire eye, set to 2).
7. Use a Max amount of time to be on, if yes set a value.
8. Press to go to other inputs to adjust or press HOME when finished.
9. Press DONE when finished.

3 Programming

3.4 Function Flashers

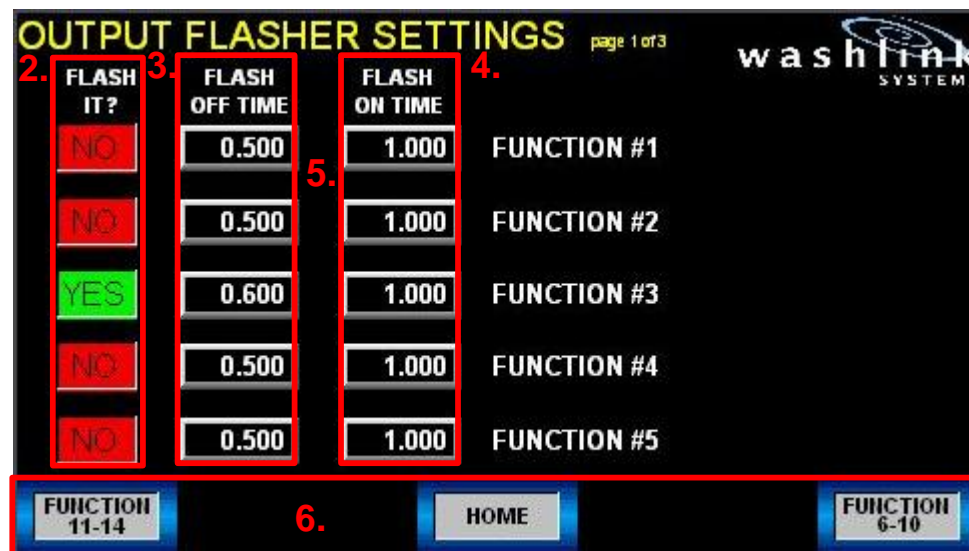
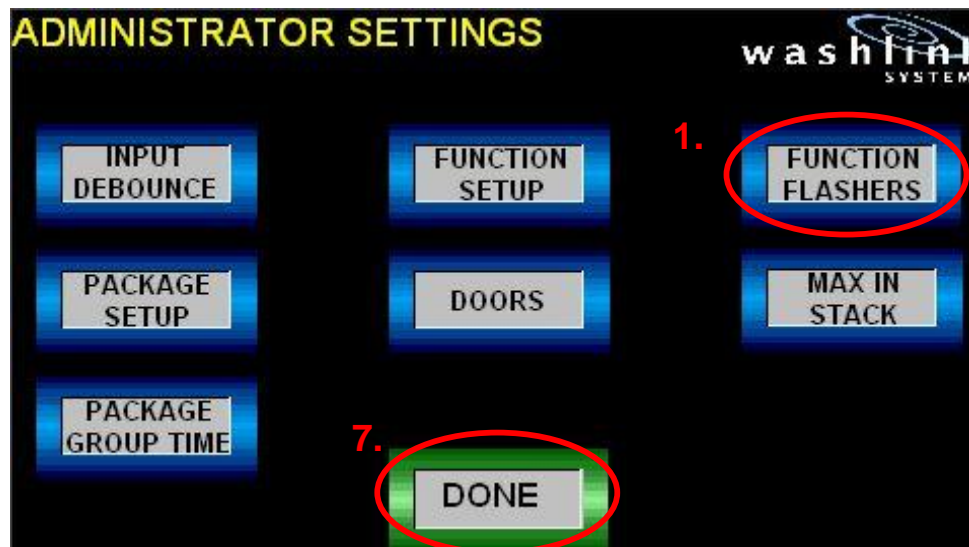

1. From the Administrator Settings page, press FUNCTION FLASHERS.
2. Flash It, do you want this function to flash NO or YES.
3. Flash Off Time, the amount of time the flasher is off between on cycles.
4. Flash On Time, the amount of time the flasher is on between on cycles.
5. Off & On Time values in xx.xxx seconds.
6. Press to go to other inputs to adjust or press HOME when finished.
7. Press DONE when finished.

3 Programming

3.5 Package Setup

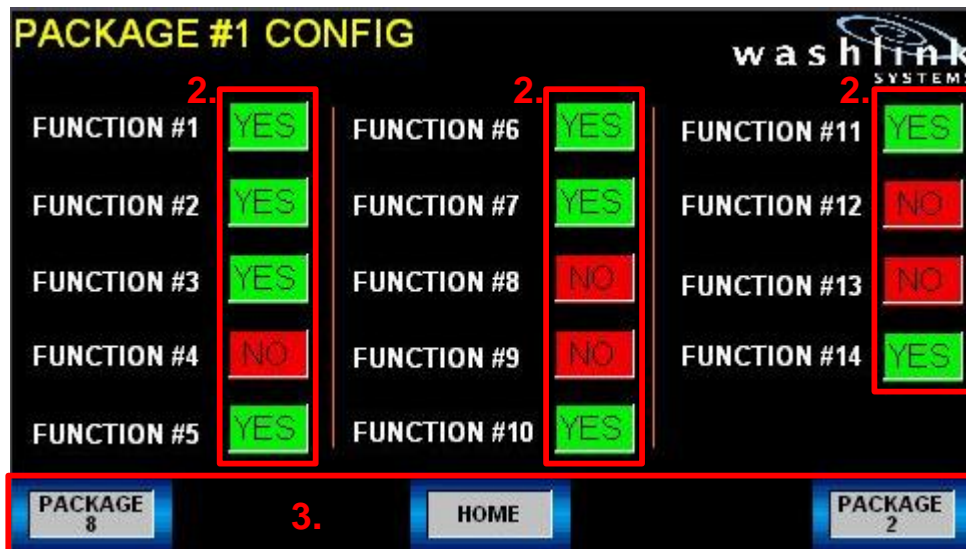
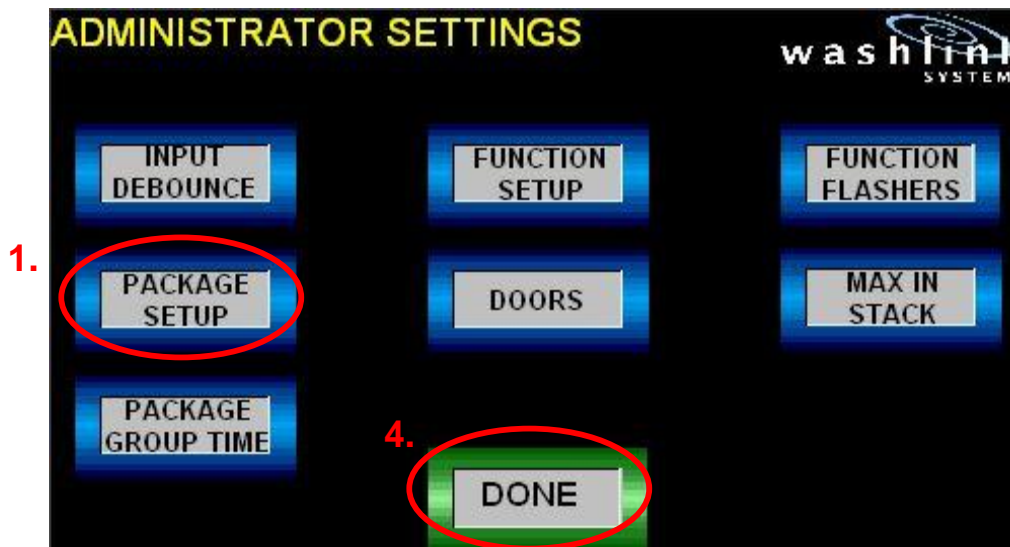

1. From the Administrator Settings page, press PACKAGE SETUP.
2. Select the functions to work for this package NO/YES
3. Press to go to other inputs to adjust or press HOME when finished.
4. Press DONE when finished.

3 Programming

3.6 Max in stack

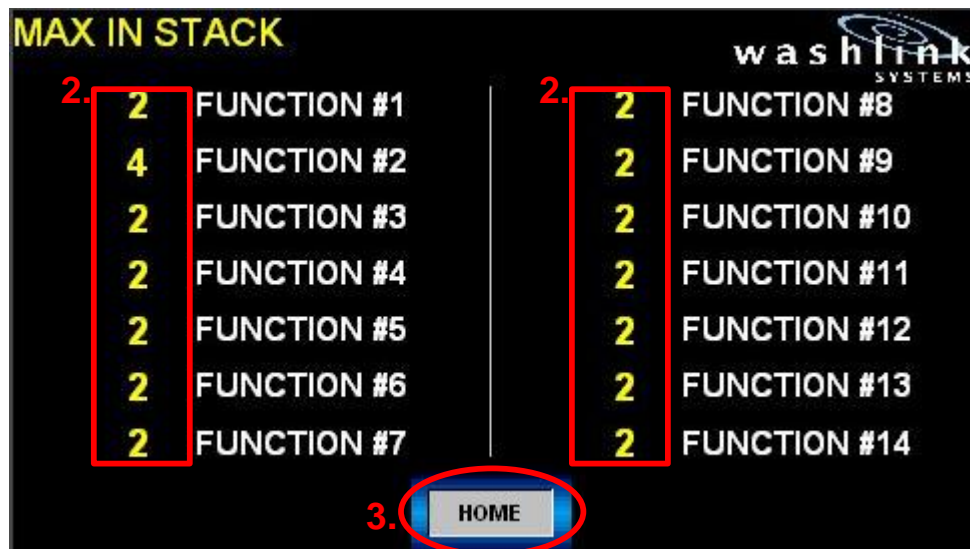
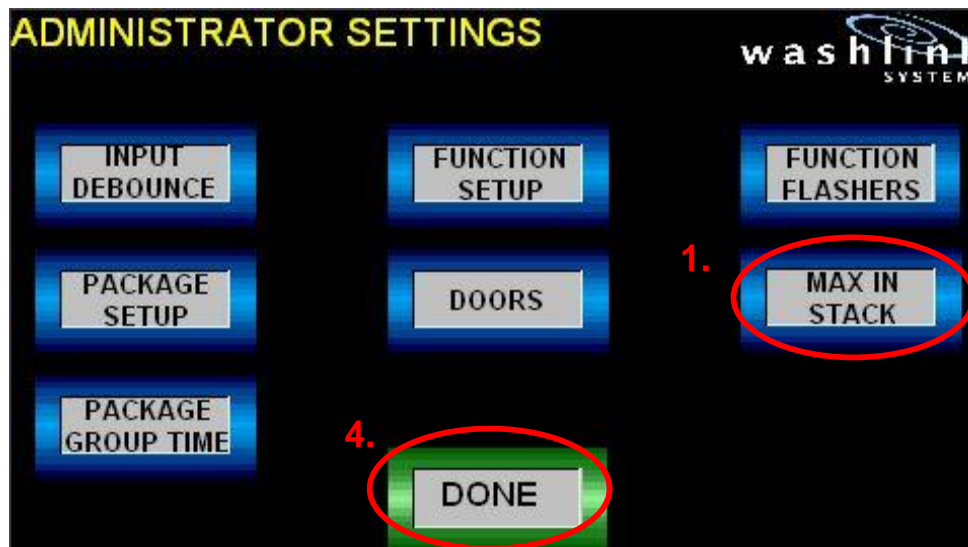

1. From the Administrator Settings page, press MAX IN STACK.
2. This number represents the max number of times the function can be stacked, to change tap number and enter new value
3. Press HOME when finished.
4. Press DONE when finished.

3 Programming

3.7 Package Group Time

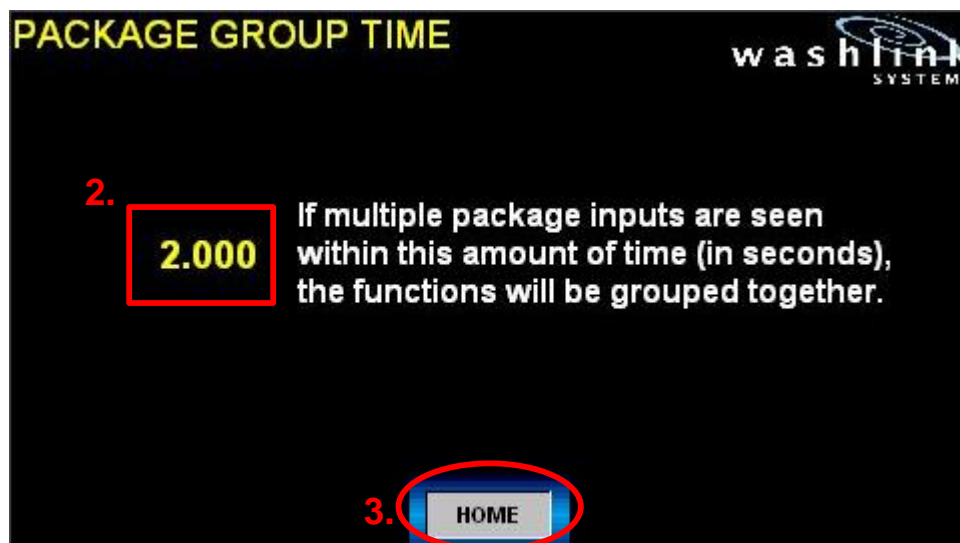
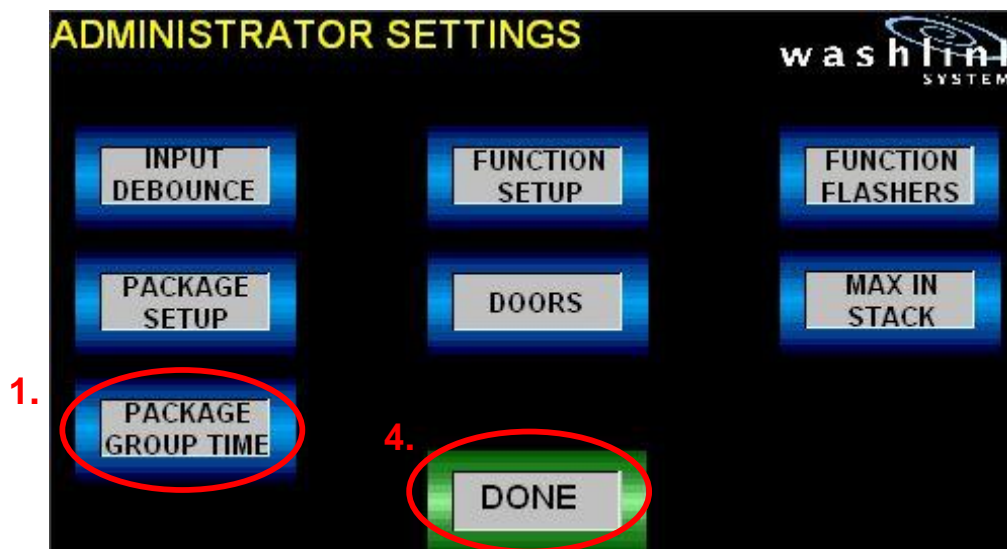

1. From the Administrator Settings page, press MAX IN STACK.
2. This value is a delay that will allow multiple package inputs to be used on the same vehicle, when more than one package inputs are seen within this amount of time, it will combine the functions together for the vehicle.
3. Press HOME when finished.
4. Press DONE when finished.

3 Programming

3.8 Entrance Door Open Control

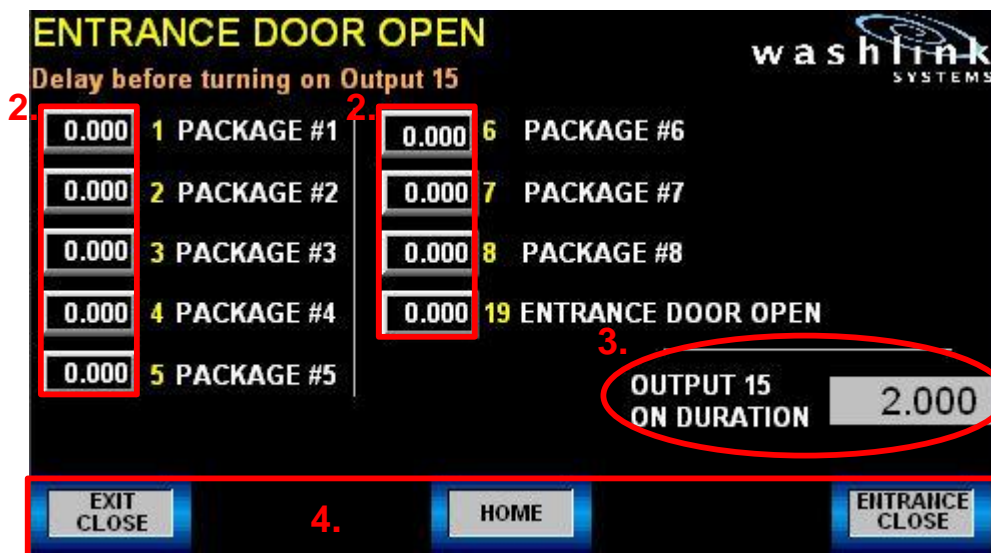
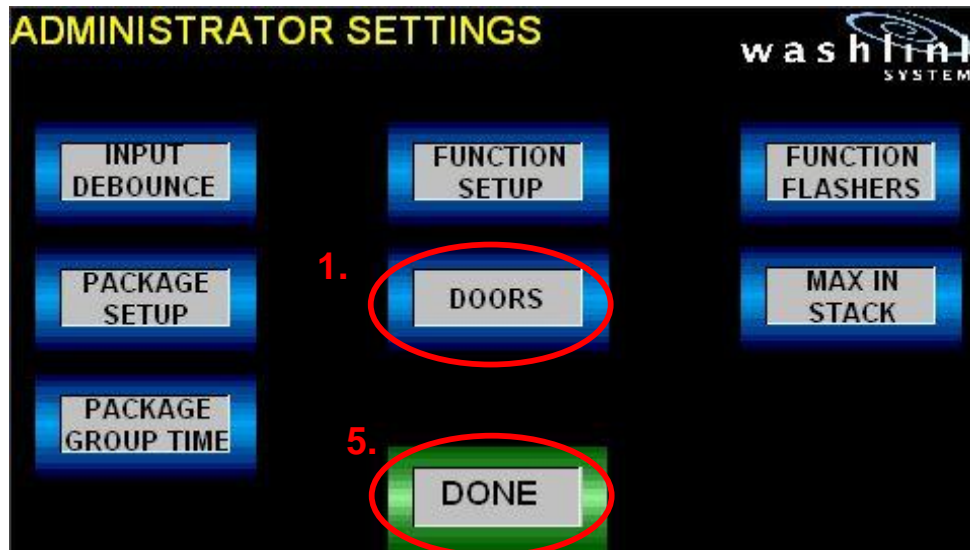

1. From the Administrator Settings page, press DOORS.
2. Delay time in seconds after the input goes high before turning on the open entrance door relay 15.
3. Amount of time in seconds the open entrance door relay 15 is on for.
4. Press to go to other door settings or press HOME when finished.
5. Press DONE when finished.

3 Programming

3.9 Entrance Door Close Control



1. From the Entrance Door Open page, press ENTRANCE CLOSE.
2. Chose what photo eye, wash in use or exit eye input you want to use to activate the close entrance door close relay 16.
3. Amount of time in seconds to delay activating relay 16 after your activation input has gone high or low.
4. Time in seconds to keep the entrance door close relay 16 turned on for.
5. Press to go to other door settings or press HOME when finished.

3 Programming

3.10 Exit Door Open Control

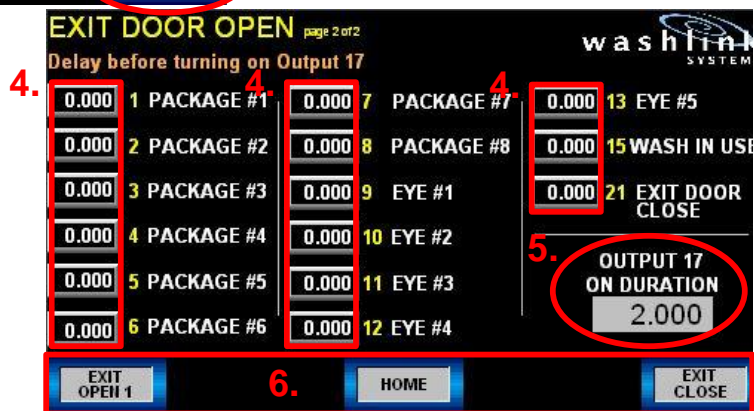

1. From the Entrance Door Close page, press EXIT OPEN 1.
2. Chose what input you want to use to activate the open exit door relay 17.
3. Press EXIT OPEN 2 .
4. Enter a Delay in seconds to wait after the inputs that are selected to open the exit door relay 17.
5. Time in seconds to keep Exit Door Open relay 17 turned on for.
6. Press to go to other door settings or press HOME when finished.

3 Programming

3.11 Exit Door Close Control

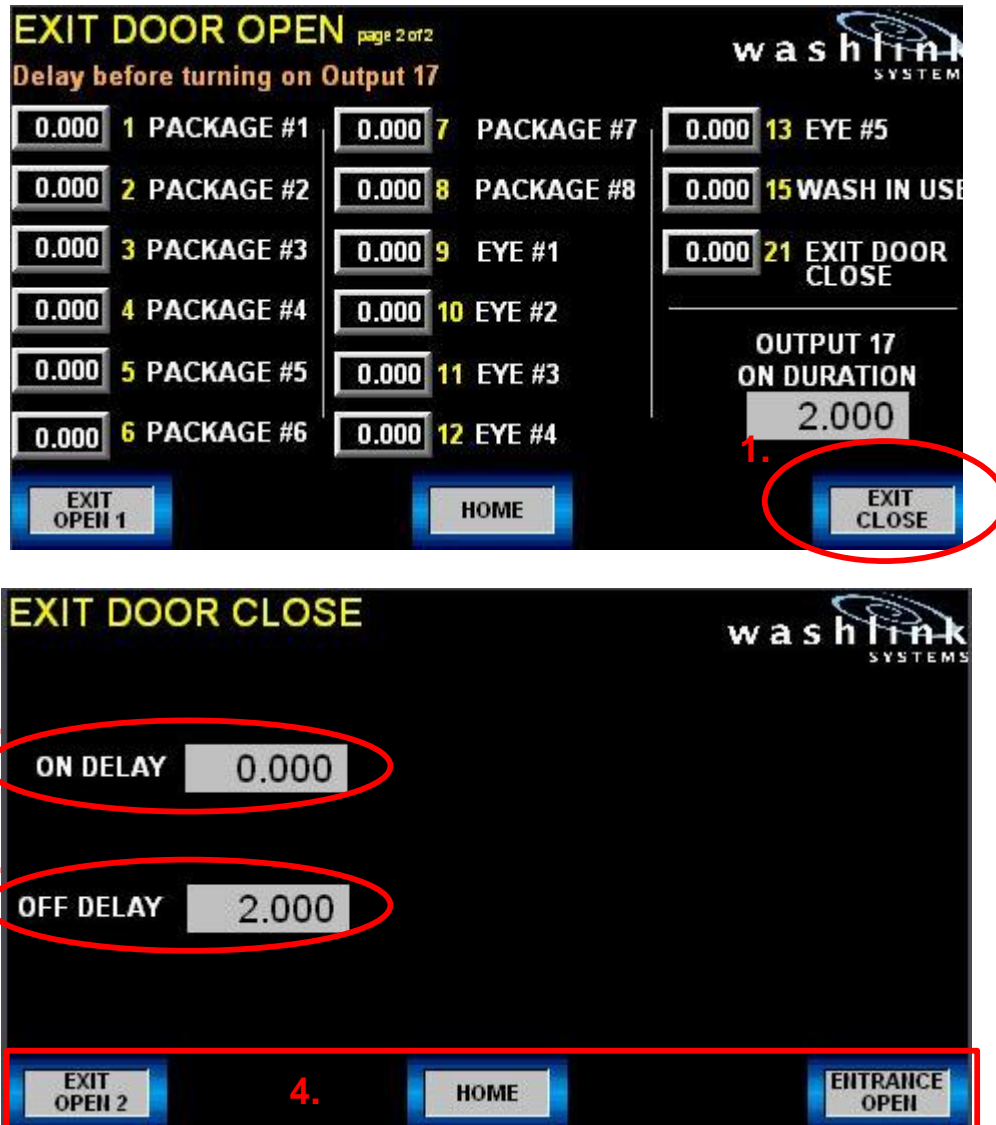

1. From the Exit Door Open 2 page, press EXIT CLOSE.
2. Amount of time in seconds you want to delay after exit eye goes low before turning on the close exit door close relay 18.
3. Time in seconds to keep the exit door close relay 18 turned on for.
4. Press to go to other door settings or press HOME when finished.

4 Real Time Input Status

4.1 Real Time Input Status

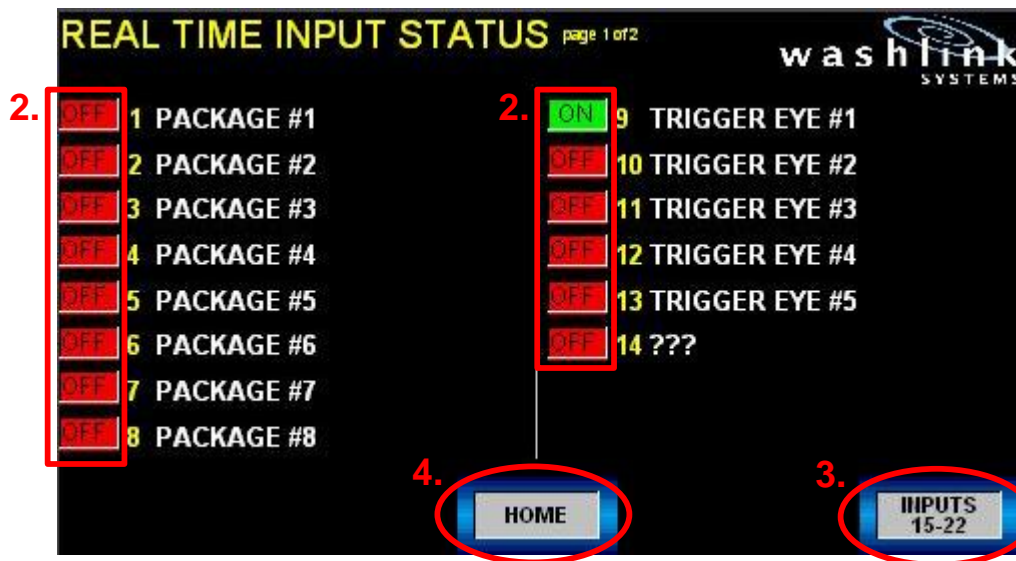
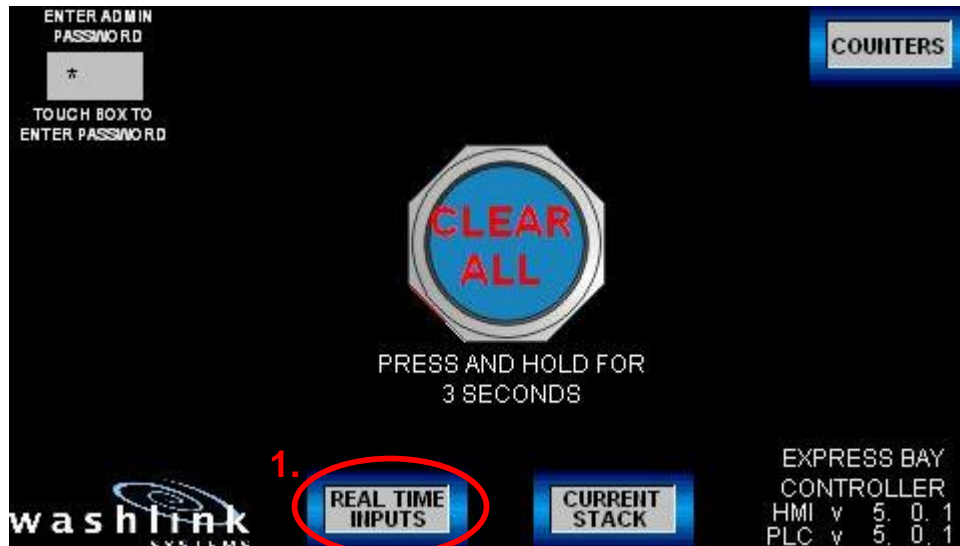

1. Press the REAL TIME INPUTS button from the HOME screen
2. OFF = Input low, ON = Input high.
3. To view more inputs, press this button.
4. When finished, press HOME.

5 Counters

5.1 Counters

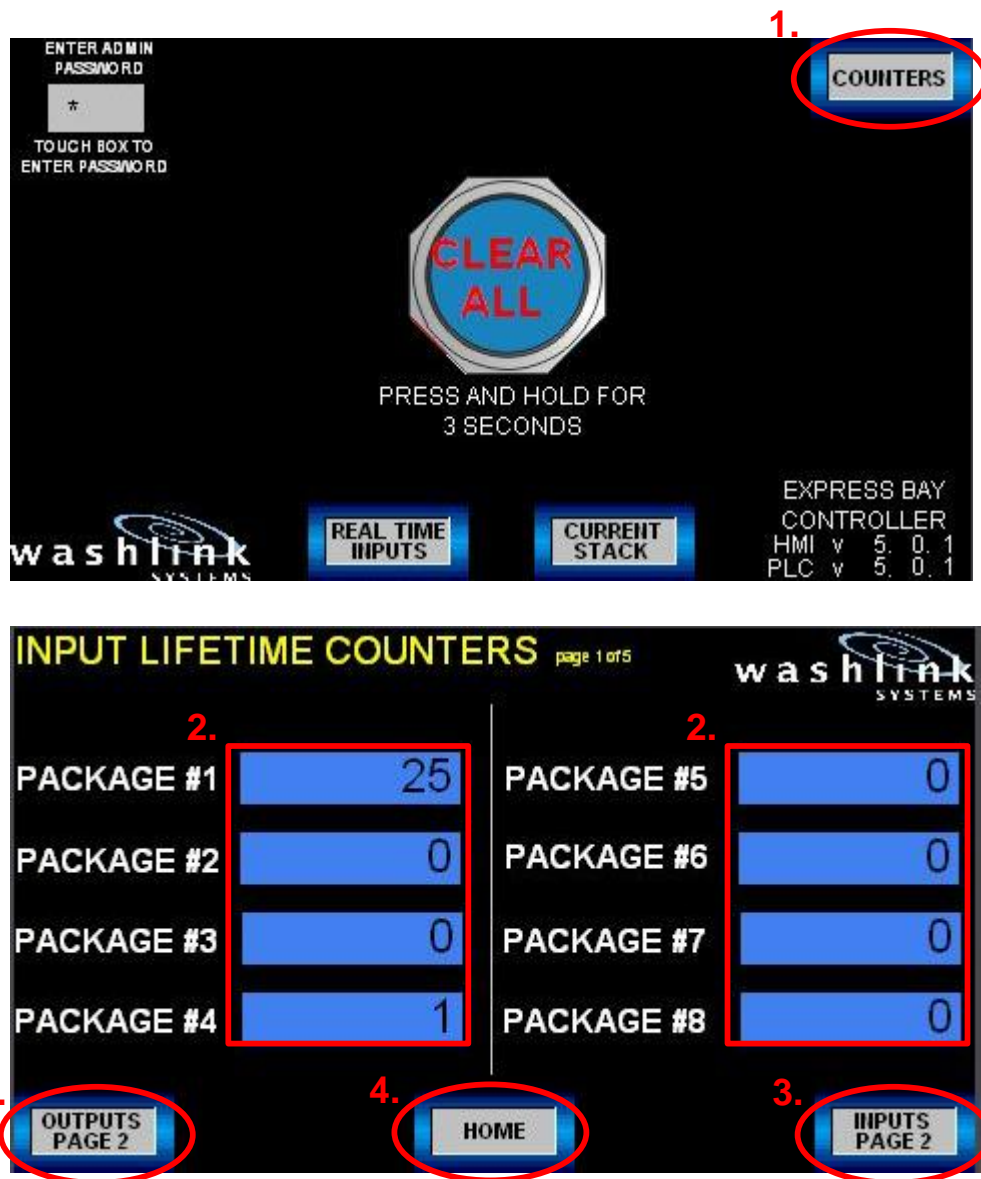

1. Press the **COUNTERS** button from the HOME screen
2. Input or Output lifetime counts.
3. To view more counters, press one of these buttons.
4. When finished, press **HOME**.

5 Counters

5.1 Counters

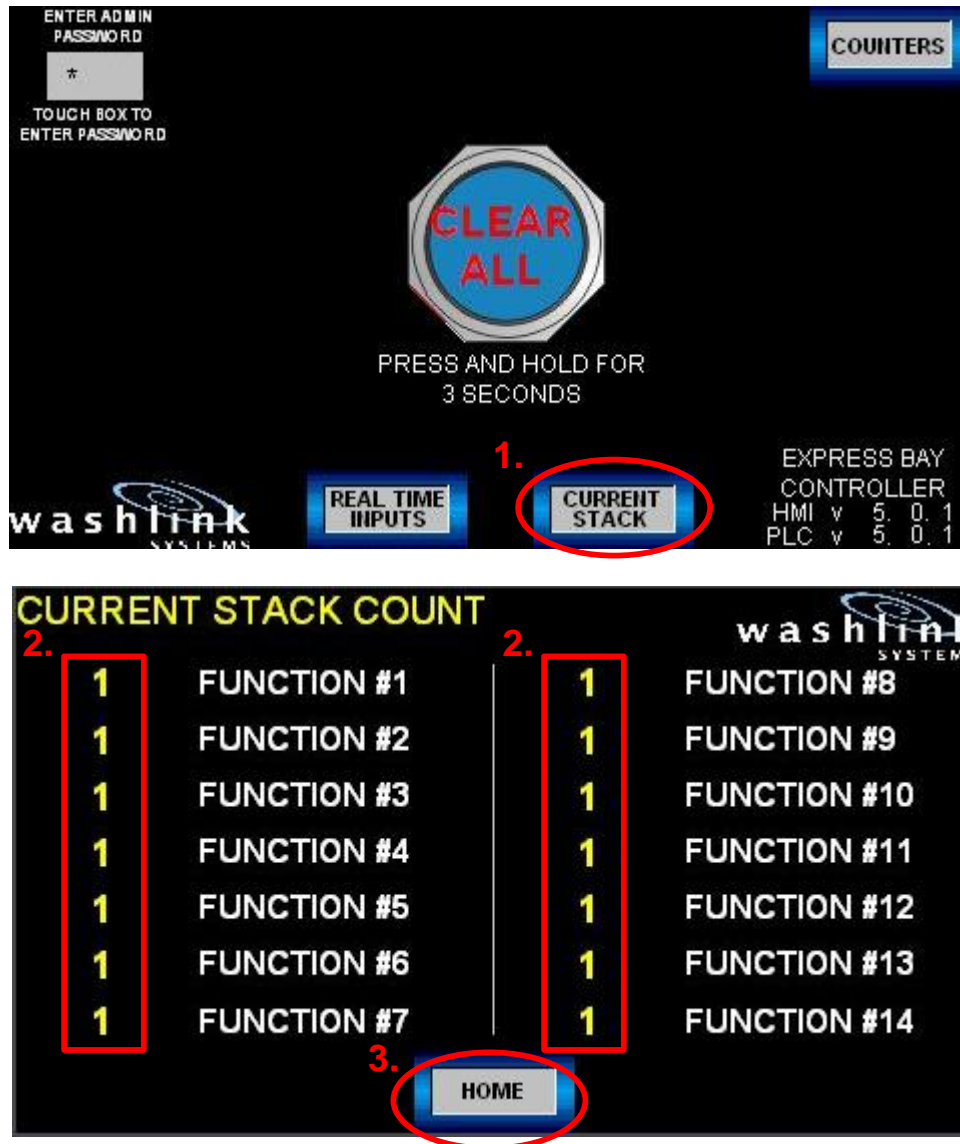

1. Press the **CURRENT STACK** button from the HOME screen
2. Value represents number in the stack for each function
3. When finished, press **HOME**.

6 Clear All

6.1 Clear All

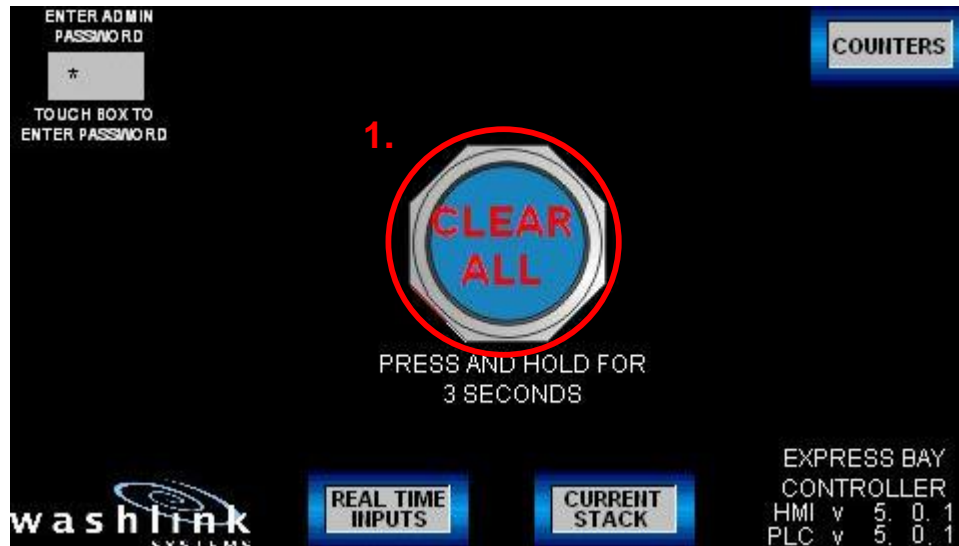

1. From the HOME screen, if this button is pressed and held for 3 or more seconds, all functions will be cleared.

NOTE: if a car is getting a function when pressed, the function will turn off!

7 Panel Build Information

The next pages show panel build information, they will show the following;

- PLC internal wiring
- Expansion module internal wiring
- Ethernet module
- Inside layout

PAGE	DESCRIPTION
0	COVER SHEET
1	PLC WIRING
2	EXPANSION MODULE 1 WIRING
3	ETHERNET SWITCH
4	PANEL LAYOUT
5	
6	
7	
8	

REV	BY	DATE	DESCRIPTION
1.0.1	MTS	120307	FOR APPROVAL

NOTES:

1. STANDARD SUPPLY VOLTAGE IS 120VAC 60Hz. OPTIONAL INTERNATIONAL VOLTAGE KIT AT 220VAC 50Hz IS AVAILABLE UPON REQUEST.
2. WASHLINK SYSTEMS RECOMMENDS INDIVIDUAL HOUSE PANEL CIRCUIT. (120VAC 15A or 220VAC 10A MAXIMUM.)
3. CIRCUIT CONFIGURED TO CUSTOMER'S VOLTAGE REQUIREMENTS. VERIFY VOLTAGE PRIOR TO STARTUP OF EQUIPMENT. (IF 24VDC, NO FUSING IS PROVIDED.)
4. ILLUMINATED LED INDICATES BLOWN FUSE.
5. WASHLINK SYSTEMS RECOMMENDS AWG 18 STRANDED COPPER WIRE FOR CIRCUITS LESS THAN 200 FEET.
6. GROUNDING OF 24VAC NEUTRAL AT TRANSFORMER ENSURES PROPER CIRCUIT ISOLATION.
7. TO AVOID RISK OF FIRE AND INJURY REPLACE ONLY WITH MANUFACTURER'S ORIGINAL RATED FUSE.
- 8.
9. CUSTOMER SUPPLIED HARDWARE.



**ALL ELECTRICAL WORK SHOULD BE PERFORMED BY A QUALIFIED AND LICENSED ELECTRICIAN.
ALL ELECTRICAL WORK SHOULD MEET OR EXCEED NATIONAL AND LOCAL CODES AND ORDINANCES.**



CAUTION! RISK OF ELECTRICAL SHOCK. MORE THAN ONE DISCONNECT MAY BE REQUIRED TO BE DE-ENERGIZED BEFORE SERVICING THE EQUIPMENT.



CAUTION! TO REDUCE THE RISK OF FIRE, ONLY CONNECT TO A 120VAC CIRCUIT PROVIDED WITH 15A MAXIMUM BRANCH CIRCUIT PROTECTION IN ACCORDANCE WITH THE NEC, ANSI/NFPA 70 AND LOCAL CODE AUTHORITIES.



CAUTION! BONDING BETWEEN CONDUIT CONNECTION IS NOT AUTOMATIC AND MUST BE PROVIDED AS PART OF THE INSTALLATION.

LEGEND

- BK – BLACK (120/220VAC HOT)
- BK/OE – BLACK W/ ORANGE TRACE (120/220VAC CONTROL CIRCUIT)
- BK/YW – BLACK W/ YELLOW TRACE (120/220VAC CONTROL CIRCUIT)
- WE – WHITE (120/220VAC NEUTRAL)
- RD – RED (24VAC CONTROL CIRCUIT)
- WE/RD – WHITE W/ RED TRACE (24VAC NEUTRAL)
- BE – BLUE (24VDC POSITIVE)
- WE/BE – WHITE W/ BLUE TRACE (0VDC or 24VDC COMMON)
- BN – BROWN (CONTROL CIRCUIT)
- OE – ORANGE (CONTROL CIRCUIT)
- YW – YELLOW (CONTROL CIRCUIT)
- PE – PURPLE (CONTROL CIRCUIT)
- WE/BN – WHITE W/ BROWN TRACE (CONTROL CIRCUIT)
- WE/OE – WHITE W/ ORANGE TRACE (CONTROL CIRCUIT)
- WE/YW – WHITE W/ YELLOW TRACE (CONTROL CIRCUIT)
- WE/PE – WHITE W/ PURPLE TRACE (CONTROL CIRCUIT)

- ENCLOSURE CONVENIENCE TERMINAL
- FUSE HOLDER
- MOMENTARY N/O PUSH BUTTON
- MAINTAINED N/C PUSH BUTTON
- RELAY COIL
- RELAY CONTACT N/O
- LEVEL SWITCH N/C
- PHOTO EYE N/O
- PROXIMITY SWITCH N/O
- LIMIT SWITCH N/O

FIELD WIRING
ENCLOSURE WIRING _____

		18805 adams court #110 morgan hill ca 95037 +1.408.924.0808 washlinksystems.com									
		<table border="1"> <thead> <tr> <th>REV</th> <th>DATE</th> <th>PAGE DESCRIPTION:</th> </tr> </thead> <tbody> <tr> <td>1.0.1</td> <td>1/30/2012</td> <td rowspan="3">COVER</td> </tr> <tr> <td colspan="2">DRAWN BY: SH</td> </tr> <tr> <td colspan="2">CHECKED BY:</td> </tr> </tbody> </table>	REV	DATE	PAGE DESCRIPTION:	1.0.1	1/30/2012	COVER	DRAWN BY: SH		CHECKED BY:
REV	DATE	PAGE DESCRIPTION:									
1.0.1	1/30/2012	COVER									
DRAWN BY: SH											
CHECKED BY:											
<p>NOT TO SCALE</p>		<table border="1"> <tr> <td>DRAWN DATE: 1/30/2012</td> <td>21 of 25</td> </tr> </table>	DRAWN DATE: 1/30/2012	21 of 25							
DRAWN DATE: 1/30/2012	21 of 25										

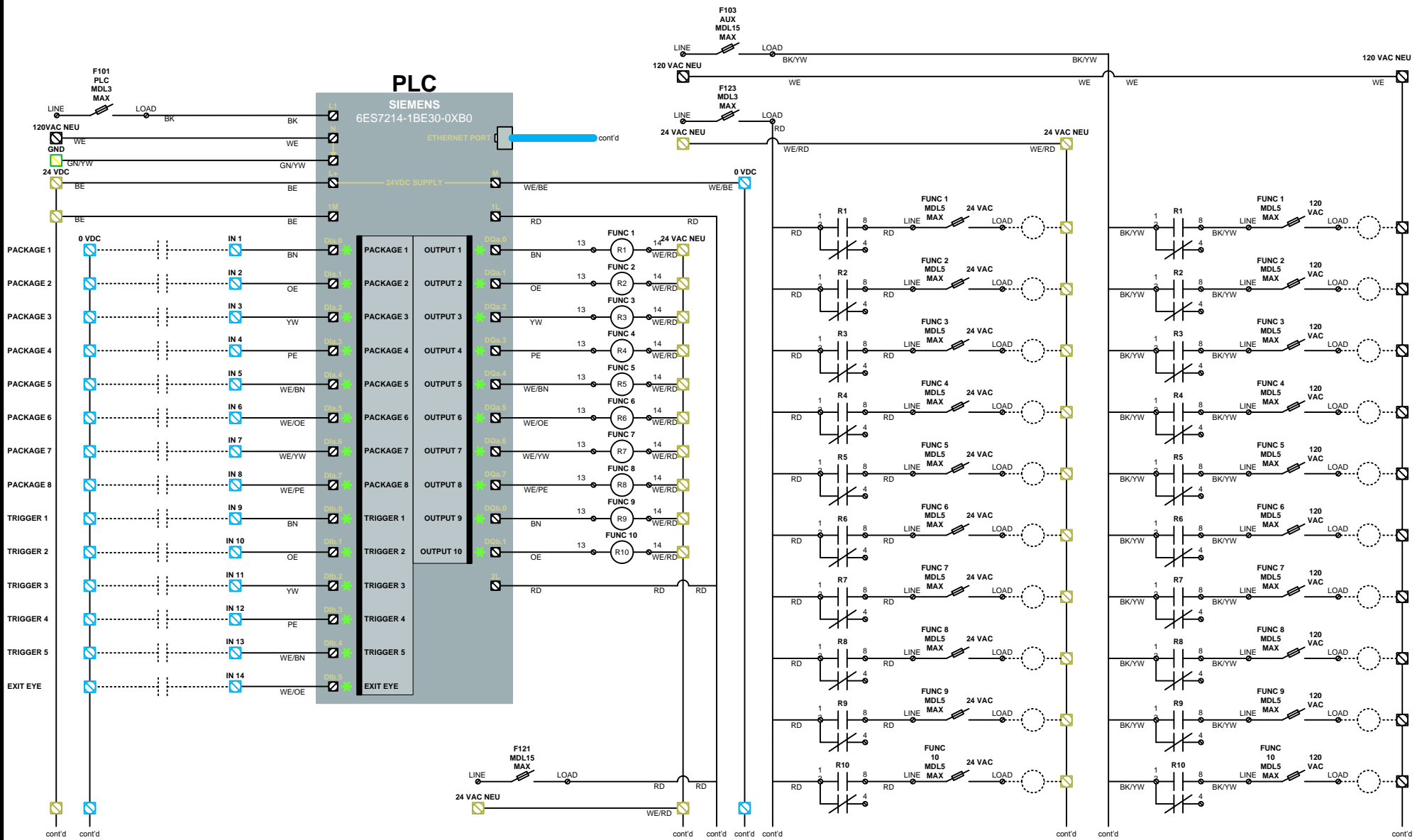



18805 adams court #110
morgan hill ca 95037
+1.408.924.0808
washlinksystems.com

REV	DATE	PAGE DESCRIPTION: <h2 style="margin: 0;">PLC</h2>	<h2 style="margin: 0;">EBC</h2>
1.0.1	1/30/2012		
DRAWN BY: SH			
CHECKED BY:			
DRAWN DATE: 1/30/2012			

22 of 25

NOT TO SCALE

EXPANSION MODULE 1

SIEMENS
6ES7223-1PH30-0XB0

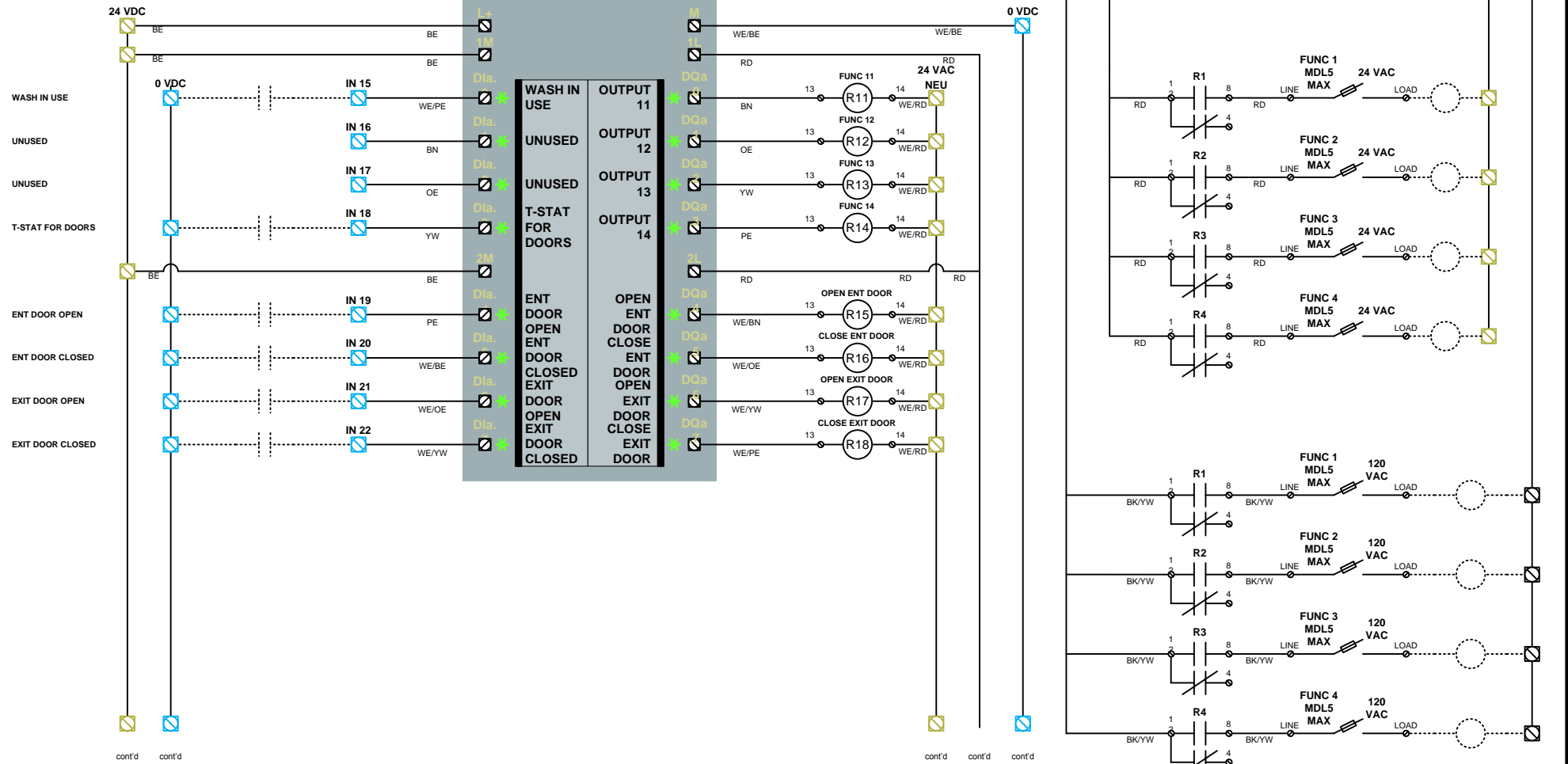



18805 adams court #110
morgan hill ca 95037
+1.408.924.0808
washlinksystems.com

REV	DATE	PAGE DESCRIPTION: EXPANSION MODULE	EBC
1.0.1	1/30/2012		
DRAWN BY: SH			
CHECKED BY:			
DRAWN DATE: 1/30/2012			

NOT TO SCALE

ETHERNET SWITCH

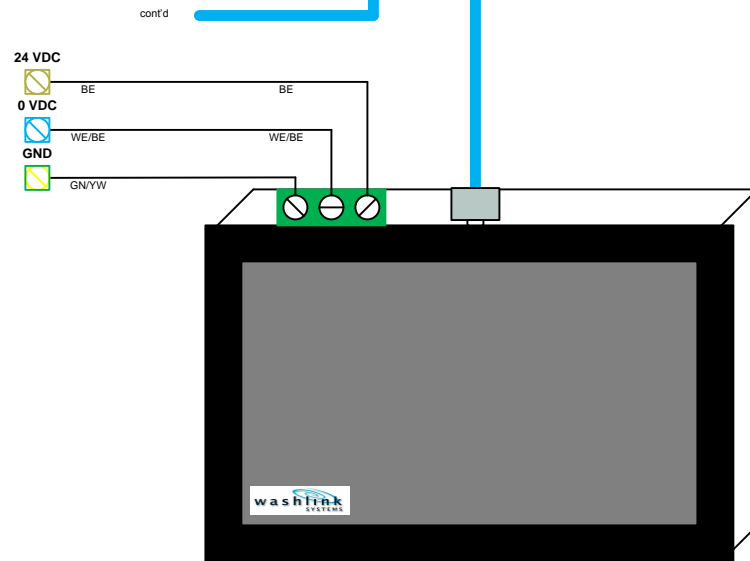
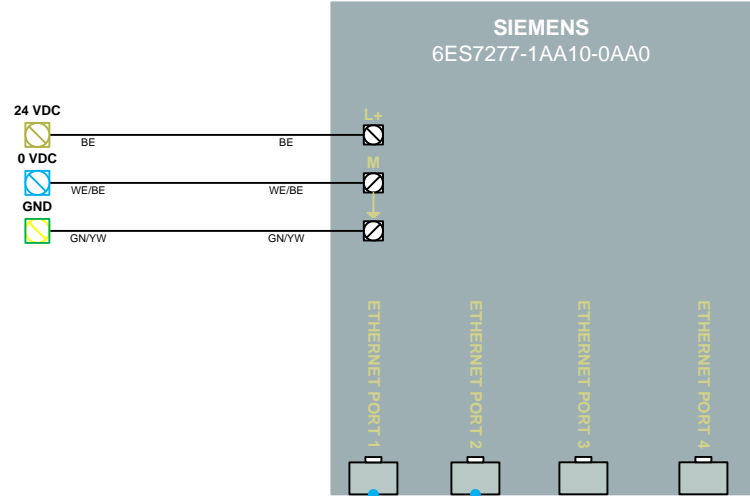

HMI 5043T

		18805 adams court #110 morgan hill ca 95037 +1.408.924.0808 washlinksystems.com	
		PAGE DESCRIPTION:	
REV	DATE	ETHERNET	
1.0.1	1/30/2012		
DRAWN BY: SH			
CHECKED BY:			
DRAWN DATE: 1/30/2012		EBC 24 of 25	

NOT TO SCALE

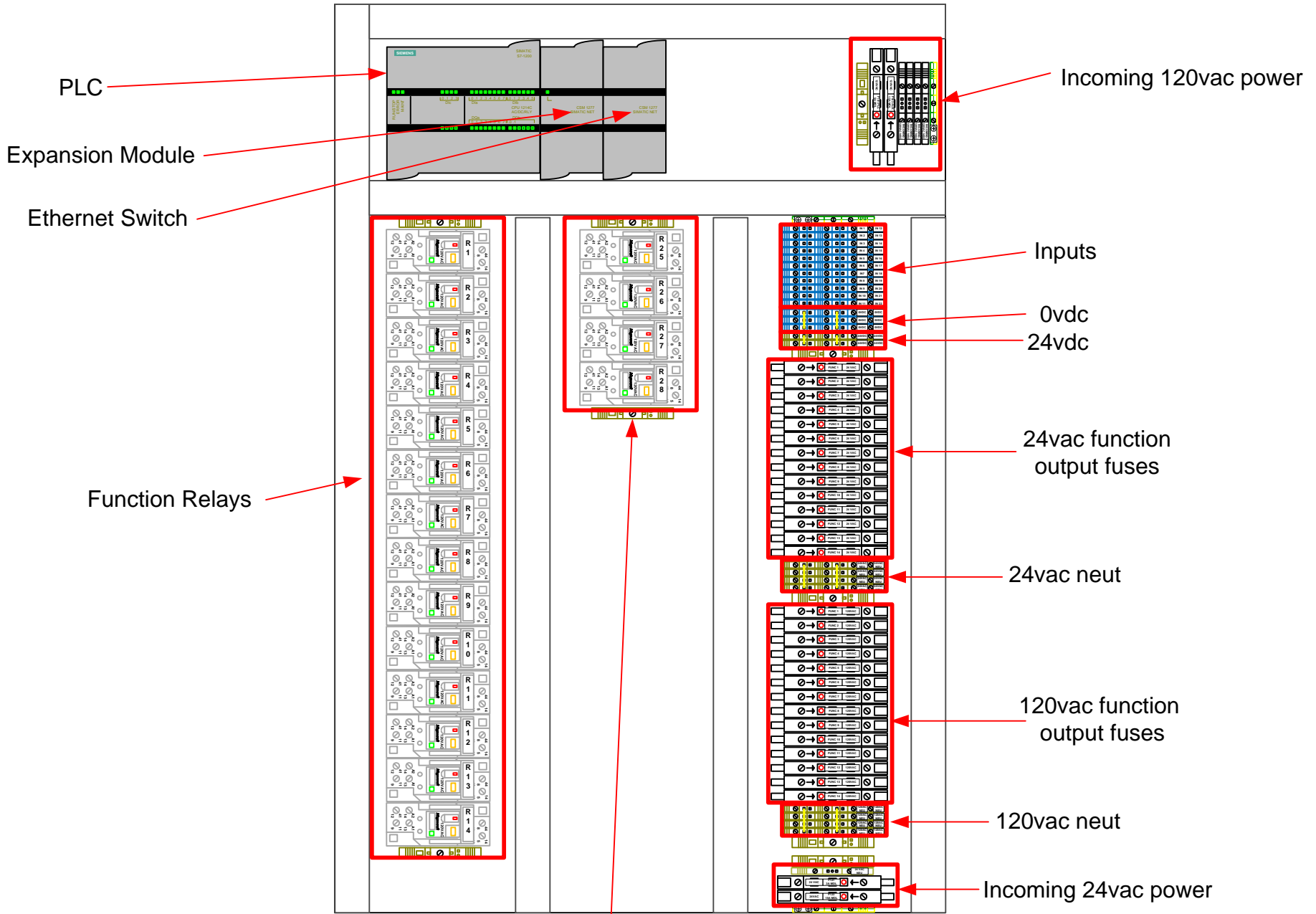

		18805 adams court #110 morgan hill ca 95037 +1.408.924.0808 washlinksystems.com	
		PAGE DESCRIPTION: LAYOUT	
REV 1.0.1 DATE 1/30/2012 DRAWN BY: SH CHECKED BY: DRAWN DATE: 1/30/2012	EBC 25 of 25		

NOT TO SCALE



**Series Three
Wash Process
Equipment Controller**

v3.0.3_jcc

Service Manual

Custom built for Jim Coleman Company / Hanna by:

washlink
SYSTEMS

Features

Ability to add Functions to any existing car wash controller

Same functionality as full size Washlink Systems Equipment Controller

Small footprint for easy installation

Multiple modes for functions;

- Full length of car

- From front of car only

- From rear of car only

- Look back

Separate inputs for each function for maximum flexibility

Easy to program data

Build in override on functions

Pre-wired and fuse protected function isolation relays

Additional 15amp dry contact for each function

Industry proven components from Siemens Worldwide

Built in counters for added security

UL Listed

Installation

Installation

Mount Micro Equipment Controller Enclosure securely to wall (best in a dry location)

Incoming Power

Apply 110vac power to L1, N and Ground

Inputs

All inputs use 0vdc, any other power will damage controller and void warranty

Enter Input

Enter Input (close contact when car in enter switch)

note: a relay may be needed if enter switch does not have an extra NO contact

Pulse Input

Pulse switch (close contact when pulse switch activated)

note: a relay may be needed if pulse switch does not have an extra NO contact

Service Inputs 1-6 (see note below)

When given a momentary closure will enable outputs 1-6 to be activated on the next car that goes through the enter switch (if car is already in enter switch, the following car will get whatever was programmed)

* If an output is going to be used for all cars being washed, put a jumper between 0vdc and the input(s).

Note: Input 1 can be configured to be clear input. If configured when a momentary closure happens, it will clear out any service inputs that would happen on the next car.

Outputs

Fuse Output (mdl15) feeds one contact on each relay

Outputs 1-6

All outputs have one contact pre-wired and can be used for either normally open or normally closed. Each relay has one additional dry contact to run an additional item at a different voltage.

Programming and Counts

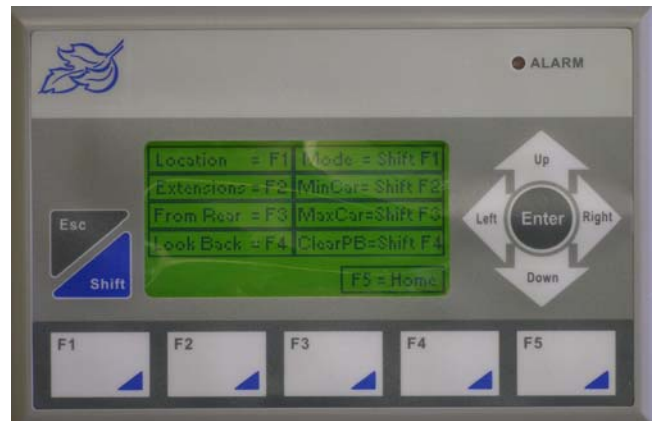

Plug in Washlink Systems Blue Leaf Programmer to port on PLC lower left

Programming Fields

Location

Distance in pulses where equipment is located

Extension

In mode 1 - additional pulses after car length to keep output on

In mode 2 - amount of pulses for output to be on

From End of Car

In mode 3 – amount of pulses from rear of car for output to turn on

Look Back

In mode 4 – keeps output on if another vehicle is within specified number of pulses

Mode

1=Full Length of Car

2=Specified number of pulses from front of car

3=Length of car minus Specified number of pulsed from rear of car

4=Look Back

Max Car Length

Sets a maximum length for a car

Min Car Length

Sets a minimum length for a car for use of output and counting

Enable Clear Input

If 0-NO clear input

If 1-service input 1 become a clear input and output 1 will turn on for all cars

Setting Data

When on the SETTING screen, press F1-F4 or Shift then F1-F4 to change settings

To go between different functions, use the arrow buttons to go up or down

When on the screen to change the settings, press F1 then use arrow buttons to change the value

Press Enter when finished

When finished press F3 to go back to Settings Screen

or

Press F5 to go back to the HOME screen

Viewing Counts

From the HOME Screen

Press F3 to go to the count screens button

Scroll up or down to view all counts

When finished, press F5 to go back to the HOME screen

Data Information

Function 1

Mode _____
Location _____
Extension _____
From End _____
Look Back _____

Maximum Car Length _____

Minimum Car Length _____

Enable Clear Input _____

Conveyor or Drive Through _

Function 2

Mode _____
Location _____
Extension _____
From End _____
Look Back _____

Function 3

Mode _____
Location _____
Extension _____
From End _____
Look Back _____

Function 4

Mode _____
Location _____
Extension _____
From End _____
Look Back _____

Function 5

Mode _____
Location _____
Extension _____
From End _____
Look Back _____

Function 6

Mode _____
Location _____
Extension _____
From End _____
Look Back _____

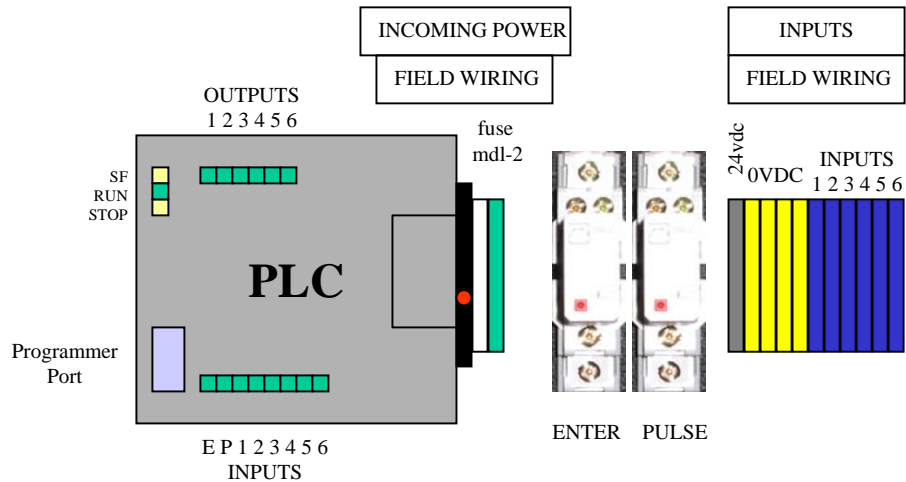

Max Torque
Fuse Holders
20 in lbs
Terminals
7 in lbs
Relay Sockets
20 in lbs

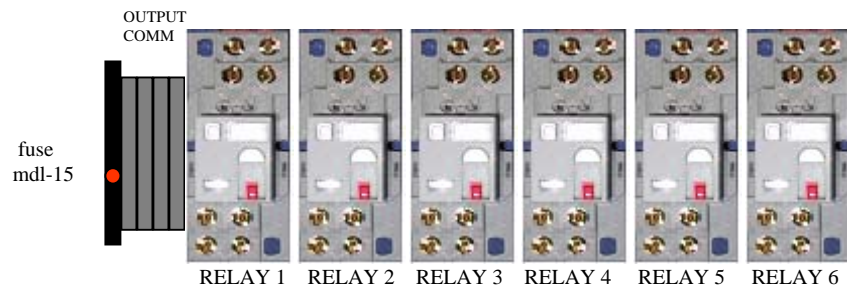

OUTPUT POWER
FIELD WIRING

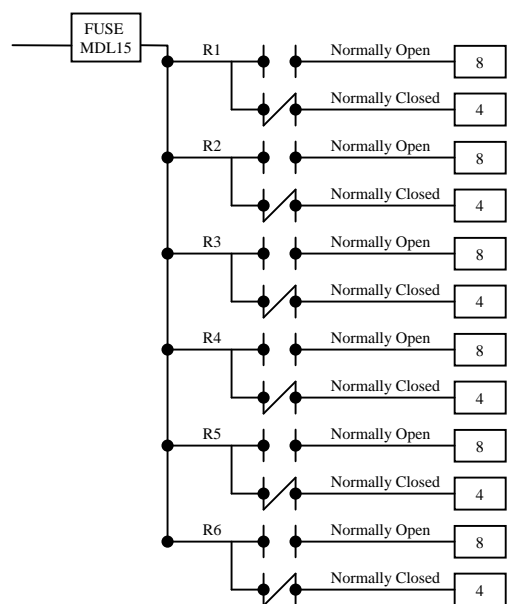
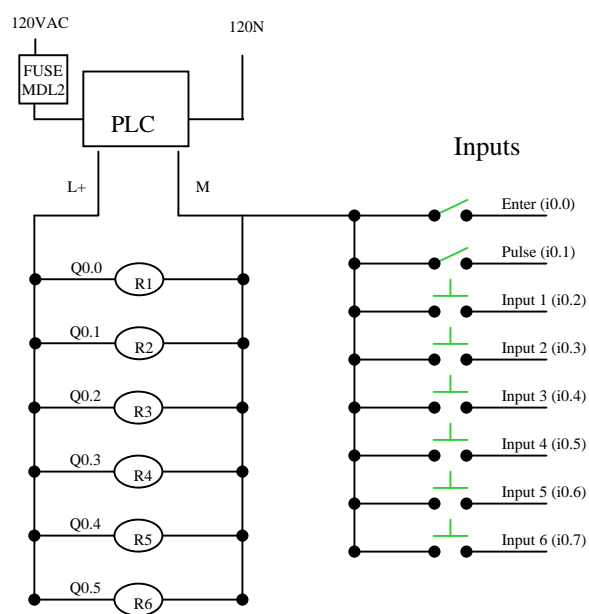

Washlink Systems, San Jose, CA 408-928-0808
Panel Drawing Micro 6
Supply Voltage 115vac
Frequency 50/60 HZ
Power Consumption 90vac
Control Voltage 24vdc
Contract Rating 15a/230vac
PILOT DUTY

Disconnect and branch circuit protection, Max 20amp listed circuit breaker, to be provided by installer
Use only copper conductors with 60°C rating or above

A1 TO N.O. SIDE EYE

A2 TO 0VDC
+24VDC TO PHOTO EYE

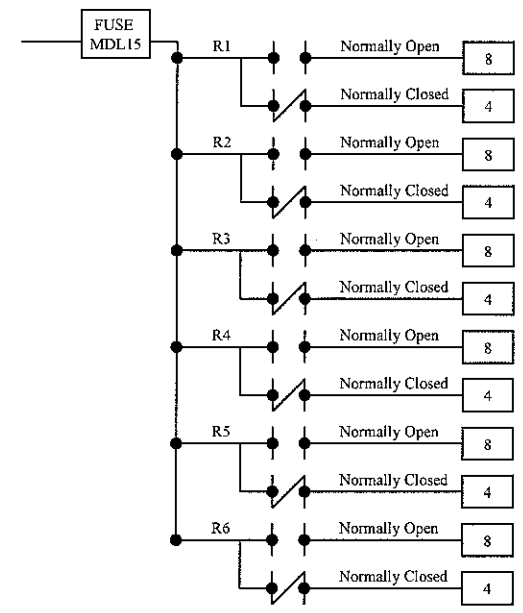
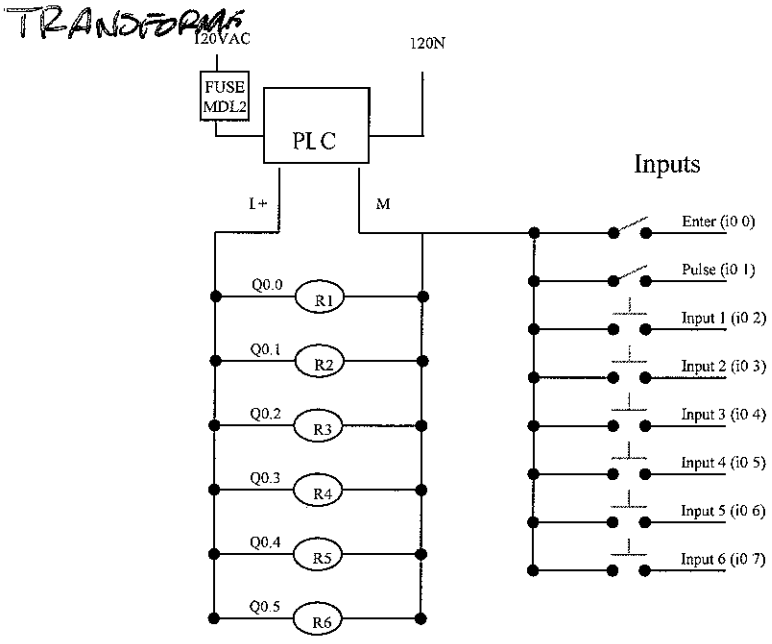
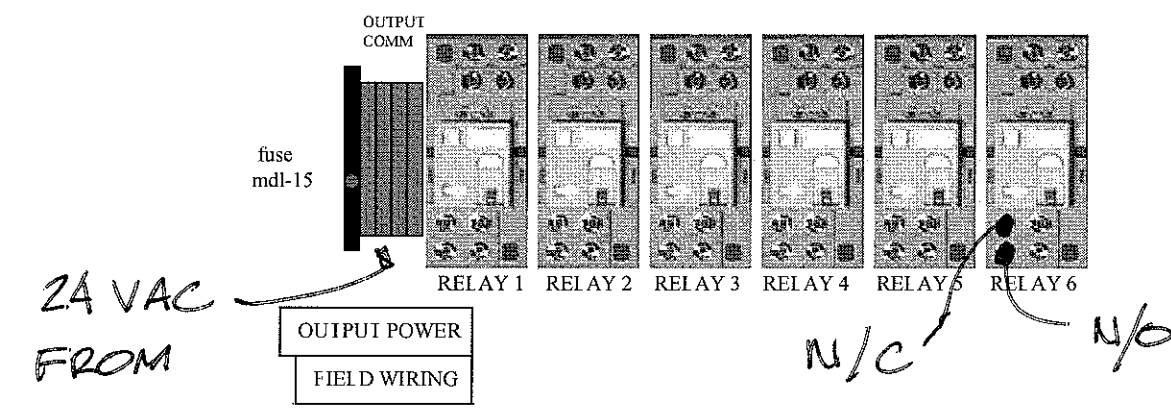
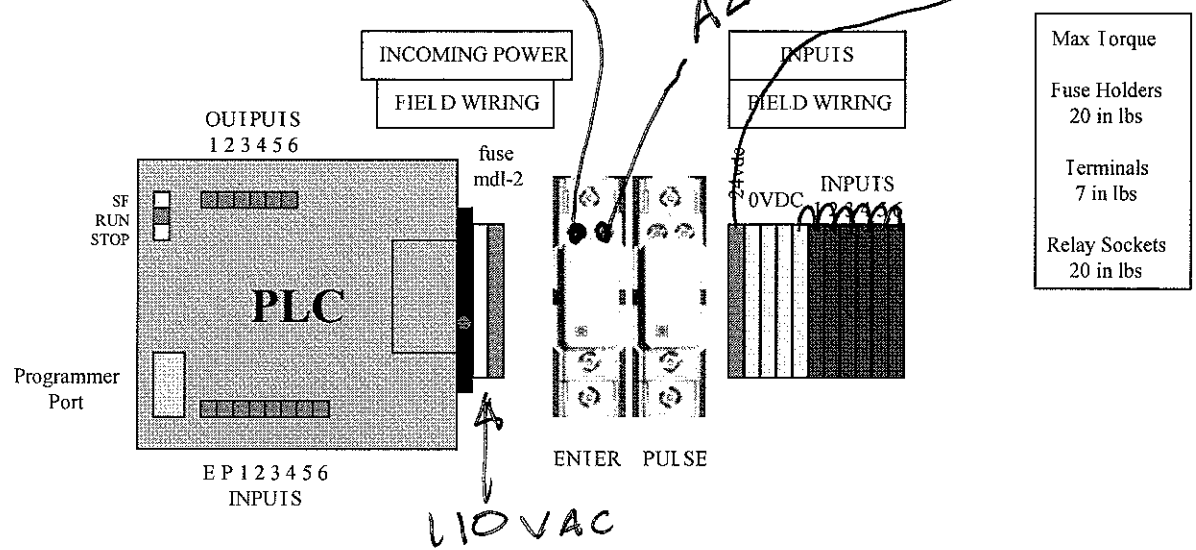

Washlink Systems San Jose, CA 408-928-0808

Panel Drawing Micro 6

Supply Voltage 115vac

Frequency 50/60 HZ

Power Consumption 90vac

Control Voltage 24vdc

Contract Rating 15a/230vac

PILOT DUTY

Disconnect and branch circuit protection, Max 20amp listed circuit breaker, to be provided by installer
Use only copper conductors with 60°C rating or above



OP73 Operator Panel User Manual

v2.0.1_jcc

Service Manual

Custom built for Jim Coleman Company / Hanna by:

washlink
SYSTEMS

TABLE OF CONTENTS

3	Legend
4	Password/Login
5	Package Counts
5	Option Counts
6	Function Setup
6	Location
6	Extension
6	Mode
7	From End
7	Look Back
7	Conveyor Interlock
8	Conveyor Setup
8	Horn On Time
8	Enter On Delay
8	Enter Off Delay
9	Simulated Pulse
9	Auto Off
10	Minimum Car Length
10	Maximum Car Length
10	Use No Package Entered
11	Roller Raiser Setup
11	Number of Rollers to Raise
11	Number of Pulses to hold Fork
11	Number of Rollers to Skip
12	Use Detect Switch
12	Roller Signal
12	Auto Roller with Package
13	Collision Avoidance Setup
13	Use Collision Avoidance
13	Sensor One On Delay
13	Sensor Two On Delay
13	Auto Restart when Clear
14	Package Setup
14	Option Setup
15	Wet Down Setup
16	Stacker
17	System Enable
18	PLC Clock
19	Critical Input Status
20	Setting Chart Functions 3-32
21	Setting Chart Functions 33-64
22	Notes

OP73 OPERATOR PANEL

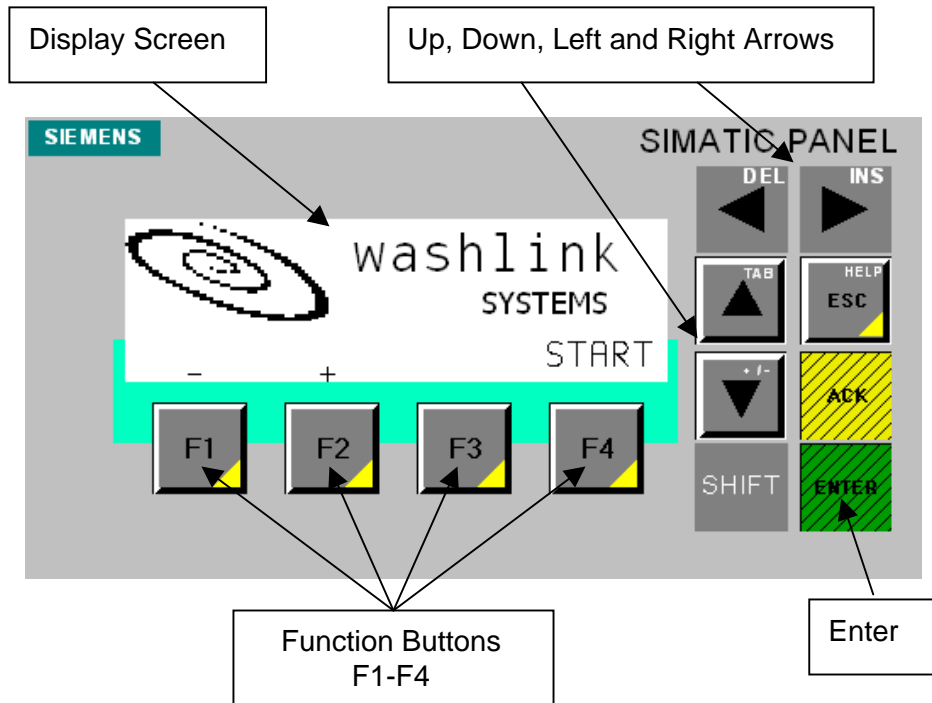

The Washlink OP73 Operator Panel allows the user the ability to change the configuration of and view counts in the Washlink Systems Equipment Controller.

When powered up the display will show the above Start Screen.

To get to the configuration or counts, press F4 (Start)

PASSWORD SCREEN

The following screens do not need a user and password;
Package Counts
Option Counts
About

All other screens need a user and password

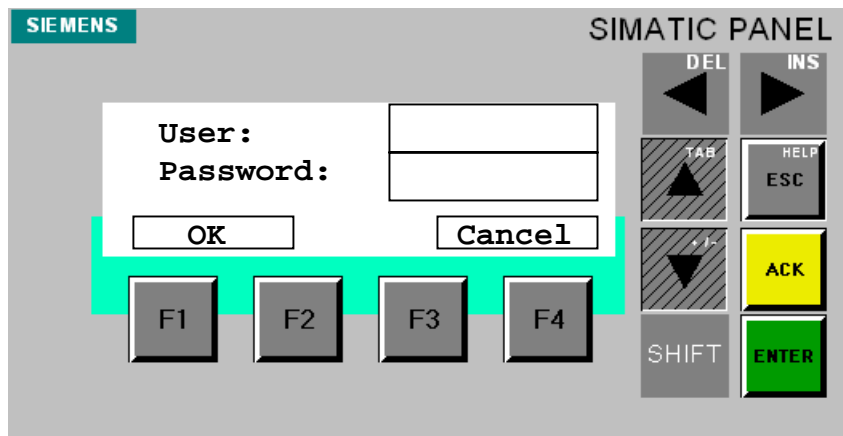

When the the above screen appears a valid user and password will need to be entered to proceed.

User = A Password = AAA

To enter the User and Password;
Scroll to the User or Password text field using the Up, Down, Left or Right arrow buttons.
Press Enter to highlight field
Use Up & Down arrows to change value
Use Left & Right arrows to move within a field
When done in a field press Enter and scroll to the next field
When finished scroll to OK and press Enter

PACKAGE AND OPTION COUNTS

From Washlink Systems Start Screen (Fig1) press F4 (START)

Scroll using F1 (PREV) and F2 (NEXT) to go to the Package (Fig 2) or Option (Fig 3) Counts

When at the desired screen Press F4 (GOTO) to get to that screen.

Note: F3 (EXIT) to get back to Washlink Systems Start Screen

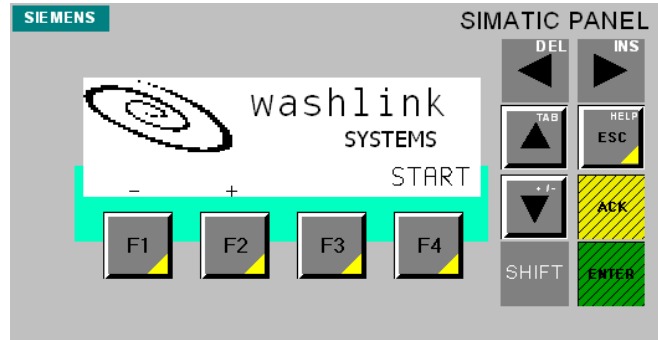

Fig 1

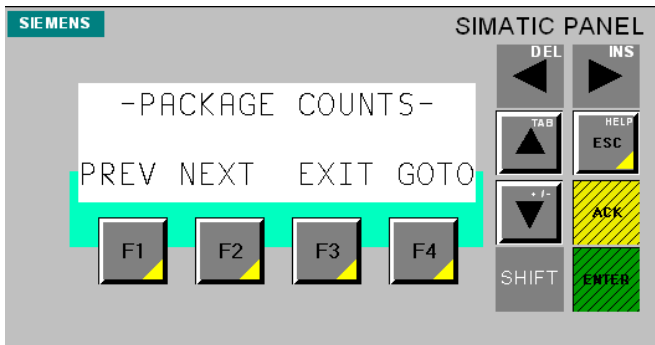

Fig 2

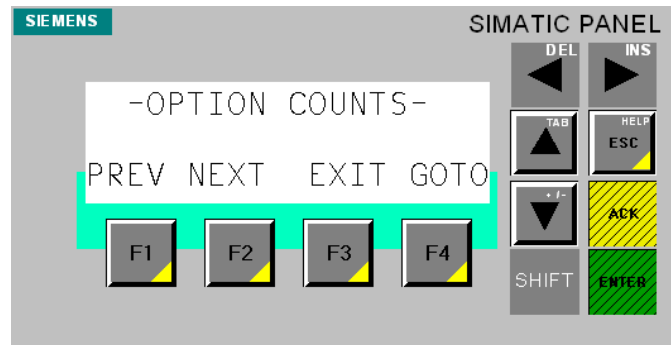

Fig 3

When at the Package XX (Fig 4) or Option XX (Fig 5) Lifetime Counts Screen

Scroll using F1 (PREV) and F2 (NEXT) to get to the desired count (in upper right corner)

Note: Press the F3 (EXIT) to get back to the Package or Option Count Main Screens

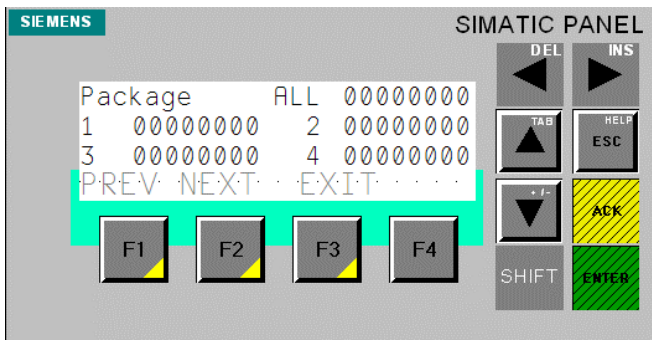

Fig 4

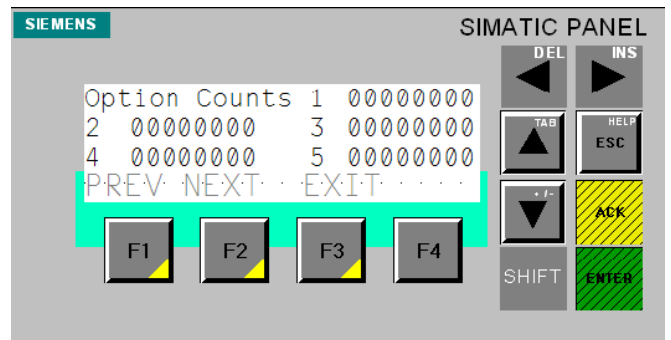

Fig 5

FUNCTION SETUP

From Washlink Systems Start Screen (Fig1) press F4 (START)

Scroll using F1 (PREV) and F2 (NEXT) to get to System Config (Fig 2) Screen

When at the System Config screen Press F4 (GOTO) to go to the Function Config (Fig 3)

When at the Conveyor Config screen Press F4 (GOTO) to go to the different settings below, scroll using F1 (PREV) and F2 (NEXT) to get to the different setting screens.

Note: F3 (EXIT) to get back to Washlink Systems Start Screen

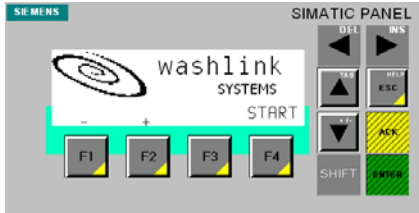

Fig 1

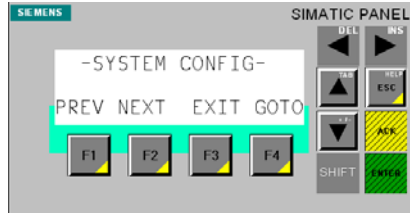

Fig 2

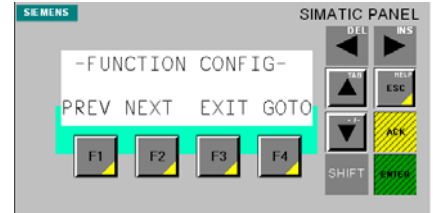

Fig 3

Note: To change a value scroll using the Up, Down, Left or Right arrow buttons to move to the desired value needing to be changed and then press Enter. Use the Up, Down, Left or Right arrow buttons to change the value. Press Enter to accept change.

Note: EXIT (F3) will bring you back to the Function Config Screen

FUNCTION # CONFIG (Fig 4)

This is a jump screen, you can scroll to a lower (F1) or higher (F2) function then press GOTO (F4) and jump to that functions values.

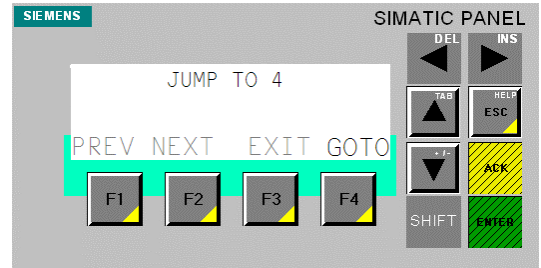

Fig 4

LOCATION (Fig 5)

This is the start location of the piece of equipment past the enter switch or tire switch if in mode 5 or 6.

Value is in pulses

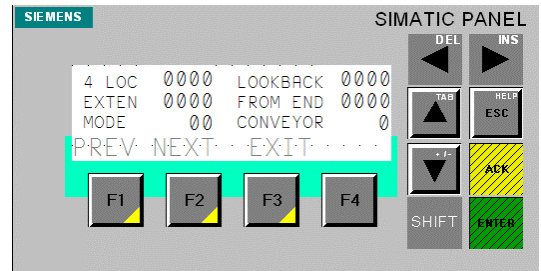

Fig 5

EXTENSION (Fig 6)

The extension value modifies the amount of time a function stays on. See modes below.

- 1-It will be added to the length of the vehicle.
- 2-The Function will only run for the value set from the front of the vehicle.
- 3-The Function will only run for the value set from the rear of the vehicle.
- 4-It will be added to the length of the vehicle.
- 5-The function will only run for the value set (value x ¼ second) for tire switch control
- 6-Same as 5 (see modes on next page)

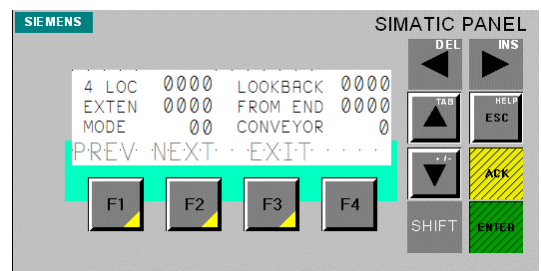

Fig 6

FUNCTION SETUP

Note: To change a value scroll using the Up, Down, Left or Right arrow buttons to move to the desired value needing to be changed and then press Enter. Use the Up, Down, Left or Right arrow buttons to change the value. Press Enter to accept change.

Note: EXIT (F3) will bring you back to the Function Config Screen

MODE (Fig 1)

Mode 1-value in Extension is added or subtracted from full the length of vehicle. Function turns on at front of vehicle

Mode 2-function is only on for the value in Extension. This function will turn on at the front of vehicle.

Mode 3-function operates as a Mode 1, with the exception of its turn on location. This function will turn on at the resulting location of adding the value in From End to the end of the vehicle.

Mode 4-functions operates as a Mode 1, with the exception of its turn off location. If the next vehicle is within the value in Look back, the function will stay on.

****Mode 5 & 6 Activation from Tire Switch****

Mode 5-function is only on for the specified value in the Extension screen (each number = ¼ second 14=3-1/2 sec)

Mode 6-same operation as mode 5 except the tire switch does not have to be within same location as the enter switch.

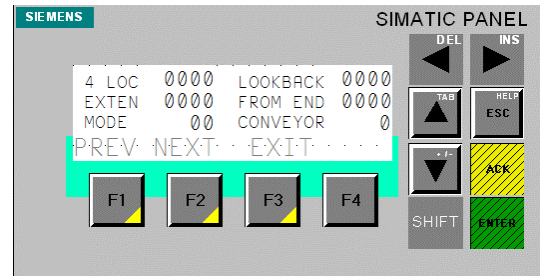

Fig 1

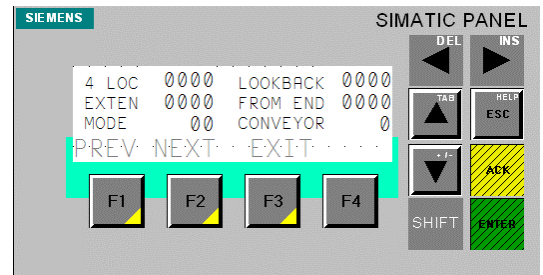

Fig 2

FROM END (Fig 2)

This gives a way to have a function turn on from the rear of the vehicle instead of the front. (rear bumper blast, open bed truck, etc) This value is referenced if function is a Mode 3.

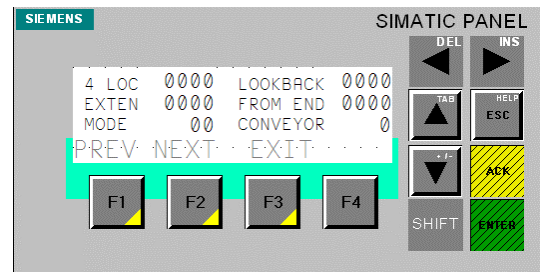

Fig 3

LOOK BACK (Fig 3)

This gives a way to keep a function on it another vehicle within the the set value. This value is referenced if the function is a Mode 4.

STAY ON (Fig 4)

This gives a way of having a function staying on (if already on) during a stop of the conveyor Value 0 function turns off with conveyor Value 1 function stays on when conveyor off

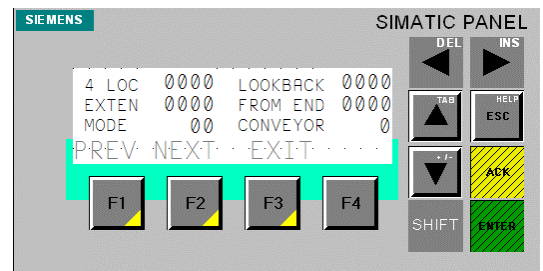

Fig 4

CONVEYOR SETUP

From the Washlink Start Screen (Fig1) press F4 (START)
 Scroll using F1 (PREV) and F2 (NEXT) to get to System Config (Fig 2) Screen
 When at the System Config screen Press F4 (GOTO) to go to the Conveyor Config Screen (Fig 3)
 When at the Conveyor Config screen Press F4 (GOTO) to go to the different settings as shown below, scroll the various setting options by using F1 (PREV) and F2 (NEXT).
 Note: F3 (EXIT) to get back to Washlink Start Screen

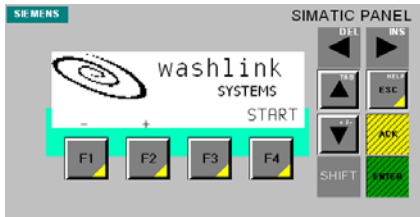

Fig 1

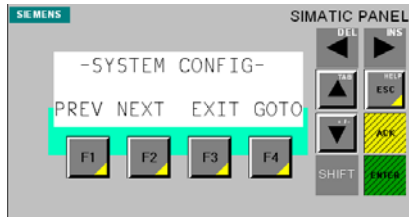

Fig 2

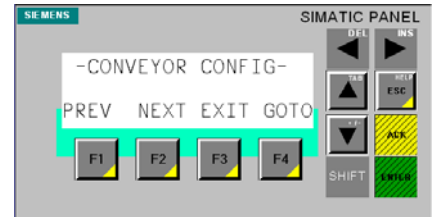

Fig 3

Note: To change a value scroll using the Up, Down, Left or Right arrow buttons to move to the desired value needing to be changed and then press Enter. Use the Up, Down, Left or Right arrow buttons to change the value. Press Enter to accept change.
 Note: EXIT (F3) will bring you back to the Conveyor Config Screen11

HORN ON (Fig 4)

This sets the amount of time the warning horn (function 1) will turn on for each time the conveyor is started.

Setting is in 1/10th (.1) second resolution.
 (for example: 25 = 2-1/2 seconds on time)

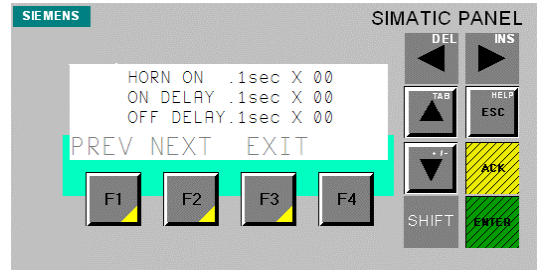

Fig 4

ON DELAY (Fig 5)

This gives a way of applying an On Delay to the Enter (input 22) this has the effect of delay when the Equipment Controller starts receiving the Enter signal.

Value is in 1/10th (0.1) second resolution.
 (for example: 5=1/2 second between pulses)

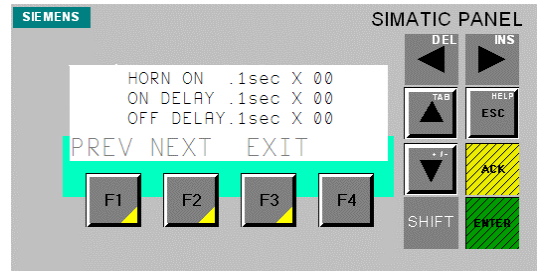

Fig 5

OFF DELAY (Fig 6)

This gives a way of applying an Off Delay to the Enter (input 22); this has the effect of extending when the Equipment Controller stops receiving the Enter signal.

Value is in 1/10th (0.1) second resolution.
 (for example: 5=1/2 second between pulses)

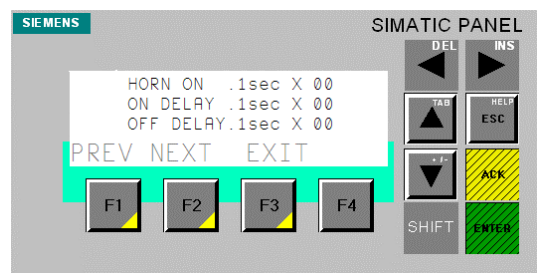

Fig 6

CONVEYOR SETUP

Note: To change a value scroll using the Up, Down, Left or Right arrow buttons to move to the desired value needing to be changed and then press Enter. Use the Up, Down, Left or Right arrow buttons to change the value. Press Enter to accept change.

Note: EXIT (F3) will bring you back to the Conveyor Config Screen

USE SIM PULSE (Fig 1)

This gives a way of still operating the car wash even if the pulse switch is inoperable.

Value 0 uses car wash pulse switch

Value 1 uses internal Sim Pulse

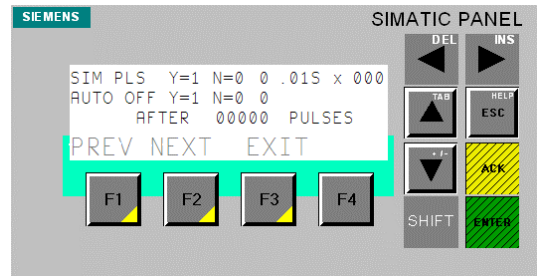

Fig 1

SIM PULSE TIME (Fig 2)

This gives a way of adjusting the time between simulated pulses when in Sim Pulse mode.

To turn on equipment earlier use a lower value.

To turn on equipment later use a higher value.

Value is in 1/100th second resolution.

Value is in 1/100th (0.01) second resolution.

(for example: 25=1/4 second between pulses)

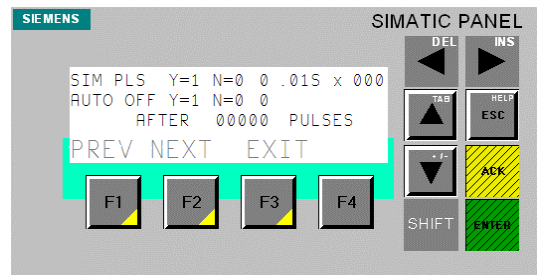

Fig 2

AUTO OFF(Fig 3)

This gives a way of having the conveyor & equipment to turn off when there are no cars being washed.

To disable Auto Off use value 0

To enable Auto Off use value 1

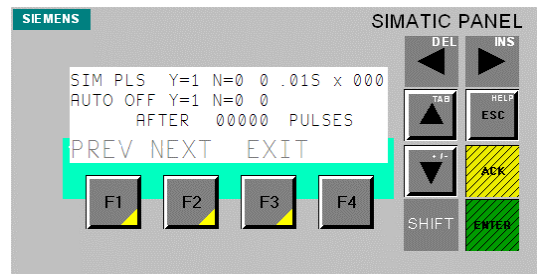

Fig 3

AUTO OFF AFTER (Fig 4)

This gives a way to adjust when the Auto Off turns off the equipment.

This value is in pulses.

To turn on equipment earlier use a lower value.

To turn on equipment later use a higher value.

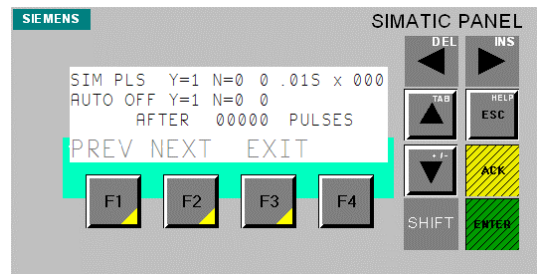

Fig 4

CONVEYOR SETUP

Note: To change a value scroll using the Up, Down, Left or Right arrow buttons to move to the desired value needing to be changed and then press Enter. Use the Up, Down, Left or Right arrow buttons to change the value. Press Enter to accept change.

Note: EXIT (F3) will bring you back to the Conveyor Config Screen

MIN CAR LENGTH (Fig 1)

This gives a way of enforcing a minimum vehicle length. Vehicles must be of this length or larger before the package entered is applied and counted.

This value is in terms of pulses.

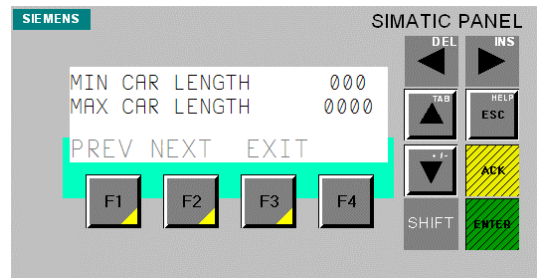

Fig 1

MAX CAR LENGTH (Fig 2)

This gives a way to enforcing a maximum vehicle length. If a vehicle exceeds this value, it will be counted and processed as normal.

However, no new package will be applied until another package is input.

This value is in terms of pulses.

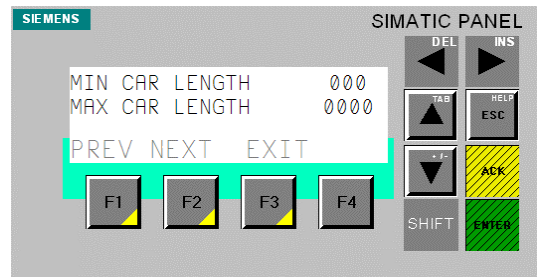

Fig 2

DO PKG 16 IF NO PKG ENTERED (Fig 3)

This gives a way of washing a car if no package has been entered and a vehicle goes through the enter (input 22).

If set to a 0 no package will be processed (vehicle will not be washed) and no count will be added.

If set to 1 package 16 will be processed

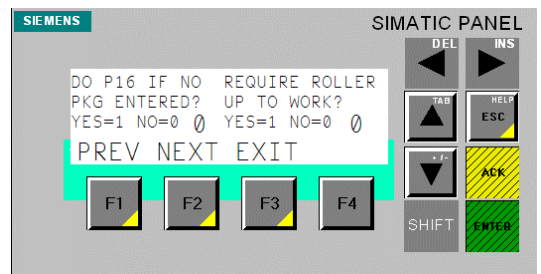

Fig 3

REQUIRE ROLLER UP TO WORK (Fig 3)

If set to 0 this will give a wash Pkg 16 when ever the enter input (i22) is activated and no Package was entered (input 1-16)

If set to 1 this requires the roller input (i35) to be activated for Pkg 16 to be given when no package (i1-i16) has been entered.

NOTE: If set to 0 and the enter goes above the max car length, it will reset and wash another Pkg 16 until a valid package has been entered and the enter input (i22) goes off

ROLLER RAISER CONFIGURATION

From Washlink Systems Start Screen (Fig1) press F4 (START)

Scroll using F1 (PREV) and F2 (NEXT) to go to the System Config (Fig 2) Screen

When at the System Config screen Press F4 (GOTO)

Scroll using F1 (PREV) and F2 (NEXT) to go to the Roller Raiser Config (Fig 3) Screen

When at the Roller Raiser Config screen Press F4 (GOTO)

Note: F3 (EXIT) to get back to Washlink Systems Start Screen

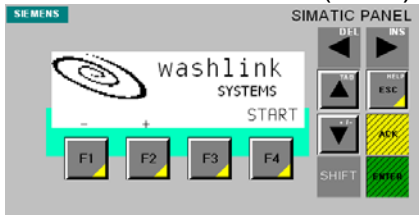

Fig 1

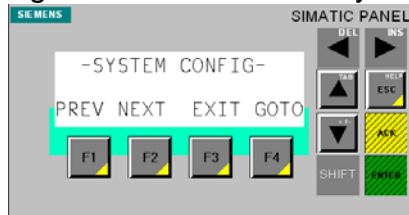

Fig 2

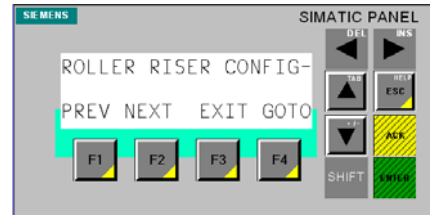

Fig 3

Note: To change a value scroll using the Up, Down, Left or Right arrow buttons to move to the desired value needing to be changed and then press Enter. Use the Up, Down, Left or Right arrow buttons to change the value. Press Enter to accept change.

Note: EXIT (F3) will bring you back to the Roller Raiser Config Screen

NUMBER OF ROLLERS (Fig 4)

This is the total number of rollers to be sent for each vehicle.

Value must be a minimum of 1

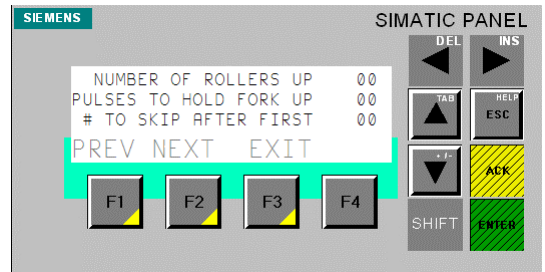

Fig 4

NUMBER OF PULSES (Fig 5)

This is the number of pulses the roller function (function 3) will be activated for each roller to be sent.

Value is in terms of pulses.

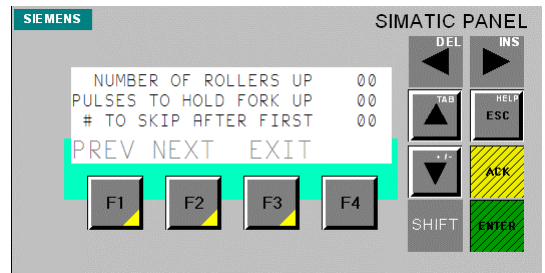

Fig 5

OF ROLLERS TO SKIP (Fig 6)

This gives the ability to skip rollers coming up in the sequence.

This is typical with front wheel pull conveyors.

Note: Value must be 1 or higher. In order to skip 2 rollers use a value of 3

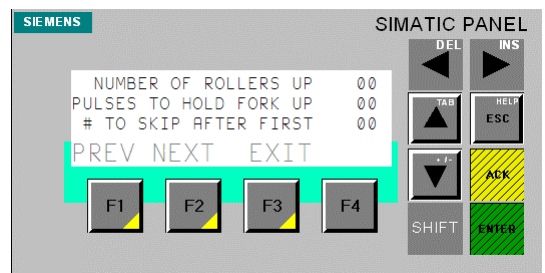

Fig 6

ROLLER RAISER CONFIGURATION

Note: To change a value scroll using the Up, Down, Left or Right arrow buttons to move to the desired value needing to be changed and then press Enter. Use the Up, Down, Left or Right arrow buttons to change the value. Press Enter to accept change.

Note: EXIT (F3) will bring you back to the Roller Raiser Screen

USE DETECT SWITCH (Fig 1)

This gives the ability to detect the position of the rollers on the conveyor. This gives the ability to accurately bring up the desired number of rollers and help prevent roller jamming. Value of 0 disables this feature. Value of 1 enables this feature (a hardware switch is necessary).

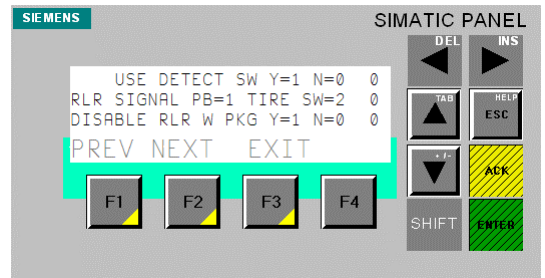

Fig 1

ROLLER UP SIGNAL (Fig 2)

This gives the ability to specify how many roller inputs must be received to do a roller cycle.

Typical values;

For push button, specify a value of 1

For tire switch (auto roller), specify a value of 2

Note: If value is higher than 1, when a push button is also used, it will have to be pressed the same number of times to do a roller cycle.

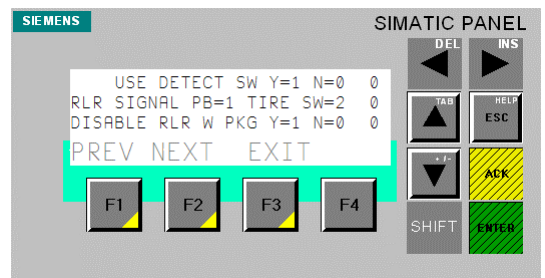

Fig 2

DISABLE AUTO ROLLER (Fig 3)

This gives a way to disable a roller cycle from happening when a package button is pressed. If value is 0 a roller cycle will happen when a package is sent.

If value is 1 a roller cycle will not happen when a package is sent.

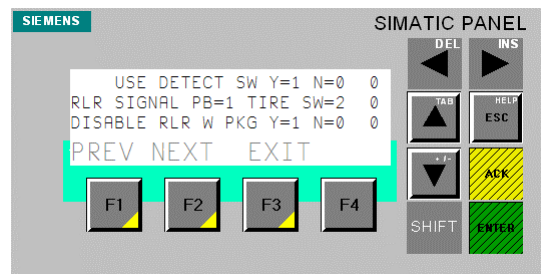

Fig 3

COLLISION AVOIDANCE

From Washlink Systems Start Screen (Fig1) press F4 (START)

Scroll using F1 (PREV) and F2 (NEXT) to get to System Config (Fig 2) Screen

When at the System Config screen Press F4 (GOTO) to go to the Collision Avoidance (Fig 3)

When at the Conveyor Config screen Press F4 (GOTO) to go to the different settings below, scroll using F1 (PREV) and F2 (NEXT) to get to the different setting screens.

Note: F3 (EXIT) to get back to Washlink Systems Start Screen

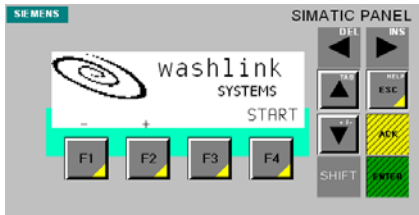

Fig 1

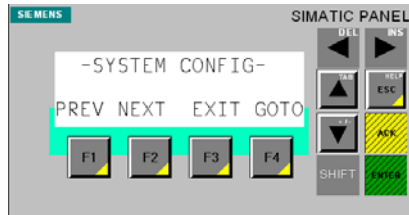

Fig 2

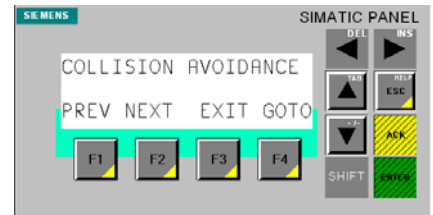

Fig 3

Note: To change a value scroll using the Up, Down, Left or Right arrow buttons to move to the desired value needing to be changed and then press Enter. Use the Up, Down, Left or Right arrow buttons to change the value. Press Enter to accept change.

Note: EXIT (F3) will bring you back to the Collision Avoidance Screen

USE COLLISION (Fig 4)

This gives a way to enable or disable the collision avoidance controls.

Value of 0 collision avoidance disabled

Value of 1 collision avoidance enabled

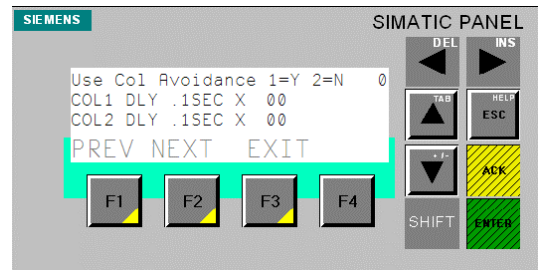

Fig 4

COL1 DLY (Fig 5)

This gives a way to give collision avoidance input 1 (i37) a delay before it will be processed.

Value is in 1/10th second resolution

(15=1-1/2 seconds)

COL2 DLY (Fig 5)

This gives a way to give collision avoidance input 2 (i38) a delay before it will be processed.

Value is in 1/10th second resolution

(15=1-1/2 seconds)

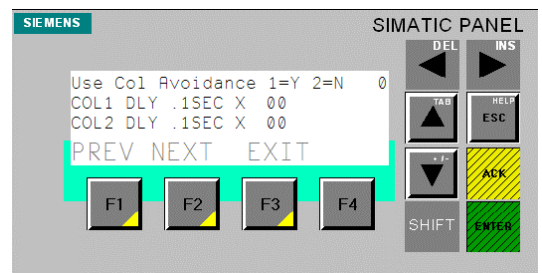

Fig 5

PACKAGE MAPPING

From Washlink Systems Start Screen (Fig1) press F4 (START)
 Scroll using F1 (PREV) and F2 (NEXT) to go to the System Config (Fig 2) Screen
 When at the System Config screen Press F4 (GOTO)
 Scroll using F1 (PREV) and F2 (NEXT) to go to the Package Mapping (Fig 3) Screen
 When at the Roller Raiser Config screen Press F4 (GOTO)
 Note: F3 (EXIT) to get back to Washlink Systems Start Screen

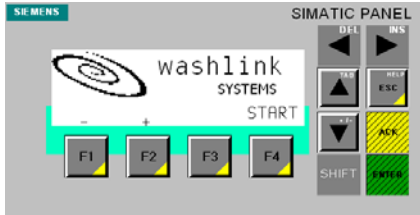

Fig 1

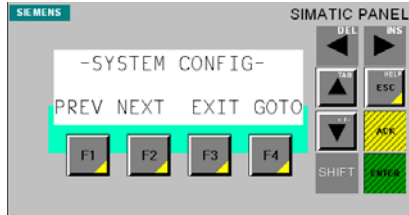

Fig 2

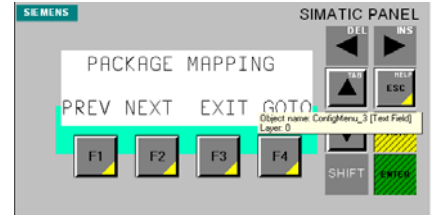

Fig 3

Note: To change a value scroll using the Up, Down, Left or Right arrow buttons to move to the desired value needing to be changed and then press Enter. Use the Up, Down, Left or Right arrow buttons to change the value. Press Enter to accept change.
 Note: EXIT (F3) will bring you back to the Package Mapping Screen

PACKAGE NUMBER 1-16 (Fig 4)

This sets the functions (67-4) to be applied for each Package.
 Value of 0 function will not be applied.
 Value of 1 function will be applied.

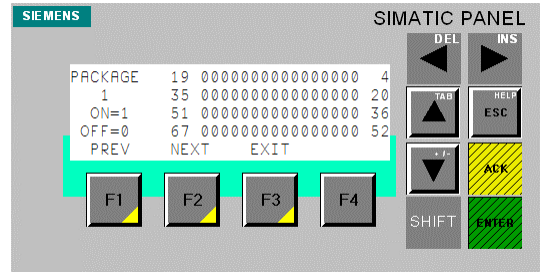

Fig 4

Note: Only one package will be applied to each vehicle. If package 1 is pressed, and then package 2 is pressed prior to the vehicle reaching the enter switch, the vehicle will get a package 2 and only a package 2 will be counted. Options must be entered after the package has been entered in order to be applied to that that vehicle with the package.

OPTION NUMBER 1-10 (Fig 5)

This sets the functions (67-4) to be applied for each Option.
 Value of 0 function will not be applied.
 Value of 1 function will be applied.

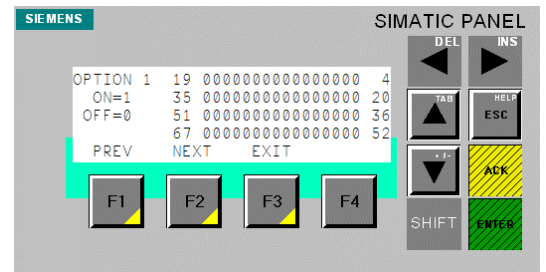

Fig 5

Note: Options will not work on their own, they must be entered after the package to be applied to a vehicle. The order and quantity of options applied to a package has no bearing on their application.

WETDOWN CONFIGURATION

From Washlink Systems Start Screen (Fig1) press F4 (START)
 Scroll using F1 (PREV) and F2 (NEXT) to go to the System Config (Fig 2) Screen
 When at the System Config screen Press F4 (GOTO)
 Scroll using F1 (PREV) and F2 (NEXT) to go to Wet Down Config (Fig 3) Screen
 When at the Wet Down Config screen Press F4 (GOTO)
 Note: F3 (EXIT) to get back to Washlink Systems Start Screen

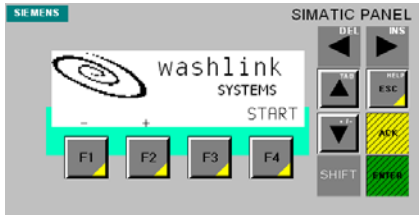

Fig 1

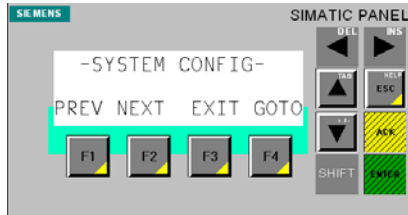

Fig 2

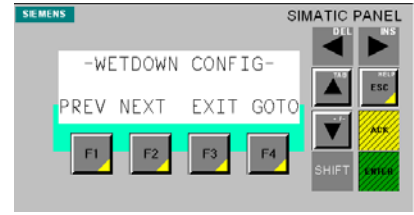

Fig 3

Note: To change a value scroll using the Up, Down, Left or Right arrow buttons to move to the desired value needing to be changed and then press Enter. Use the Up, Down, Left or Right arrow buttons to change the value. Press Enter to accept change.
 Note: EXIT (F3) will bring you back to the Conveyor Config Screen

DURATION IN MINUTES (Fig 4)

This is the duration a wet down will run for.
 Value is in terms of minutes

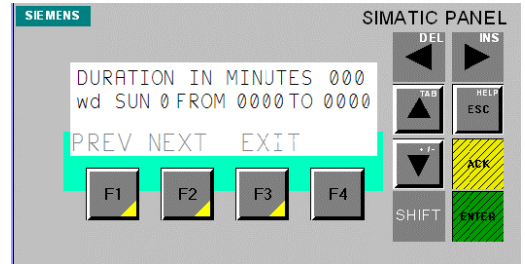

Fig 4

WD DAY (Fig 5)

This gives the ability to limit Wet Down use.
 Day: Value of 0 wet down disabled for that day
 Value of 1 wet down enabled for that day
 Time: Specifies what hours on that day wet down is permitted to operate
 Value is in terms of minutes, ranging from 0-1440
 (for example: 6:00AM-6:50AM = 360 to 410)

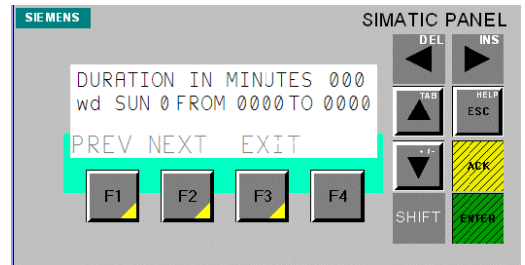

Fig 5

WET DOWN ON (Fig 6)

This specifies the functions that will turn on during a wet down
 Value of 0 off. Value of 1 on.

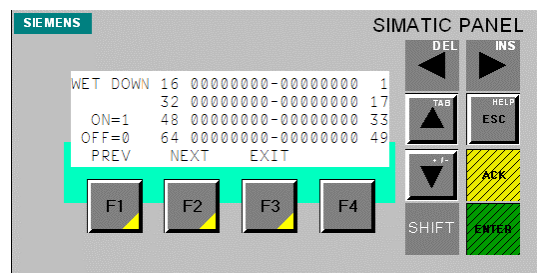

Fig 6

STACKER CONFIGURATION

From Washlink Systems Start Screen (Fig1) press F4 (START)
Scroll using F1 (PREV) and F2 (NEXT) to go to the System Config (Fig 2) Screen
When at the System Config screen Press F4 (GOTO)
Scroll using F1 (PREV) and F2 (NEXT) to go to the Roller Raiser Config (Fig 3) Screen
When at the Roller Raiser Config screen Press F4 (GOTO)
Note: F3 (EXIT) to get back to Washlink Systems Start Screen

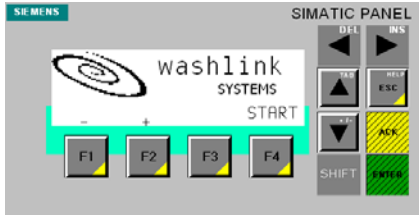

Fig 1

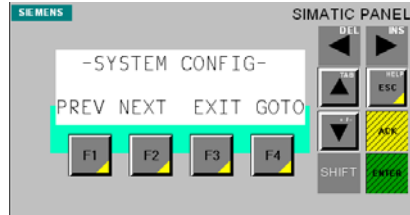

Fig 2

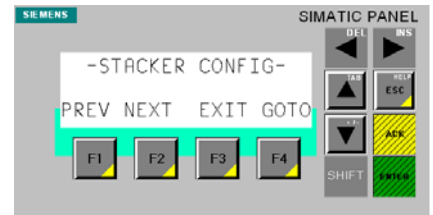

Fig 3

Note: To change a value scroll using the Up, Down, Left or Right arrow buttons to move to the desired value needing to be changed and then press Enter. Use the Up, Down, Left or Right arrow buttons to change the value. Press Enter to accept change.
Note: EXIT (F3) will bring you back to the Stacker Config Screen

USE STACKER (Fig 4)

This sets the the internal stacker on or off
Value of 0 specifies no use of the internal stacker
Value of 1 specifies use of the internal stacker

STACKER POS BASED (Fig 4)

This tells the stacker to work from a Saleslink POS or use the discreet inputs (i1-i16)
Value of 0 no, use discreet inputs (i1-i16)
Value of 1 yes, use SalesLink POS

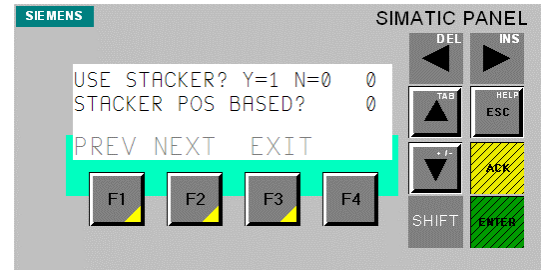

Fig 4

MAX NUMBER OF CARS (Fig 5)

This sets the maximum numbers of cars stored in the internal stacker.
Value from 0-48

IF NO CAR IN QUEUE (Fig 5)

This gives a way to wash a vehicle without it being in the queue.
Value from 0-16
0=do not wash

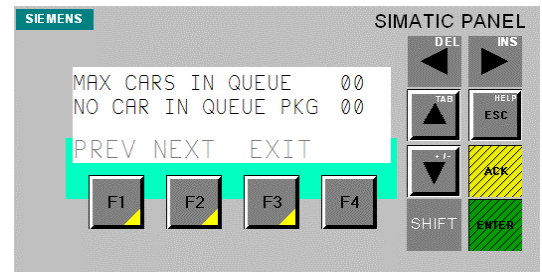

Fig 5

SYSTEM ENABLE

From Washlink Systems Start Screen (Fig1) press F4 (START)
Scroll using F1 (PREV) and F2 (NEXT) to go to the System Config (Fig 2) Screen
When at the System Config screen Press F4 (GOTO)
Scroll using F1 (PREV) and F2 (NEXT) to go to the System Enable (Fig 3) Screen
When at the Roller Raiser Config screen Press F4 (GOTO)
Note: F3 (EXIT) to get back to Washlink Systems Start Screen

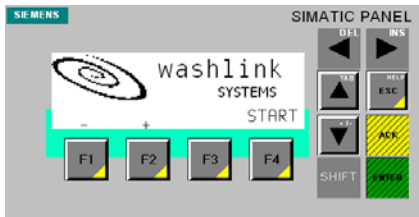

Fig 1

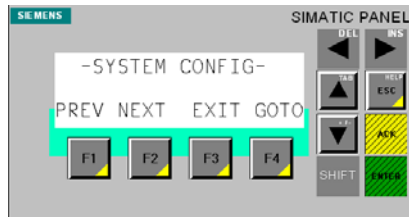

Fig 2

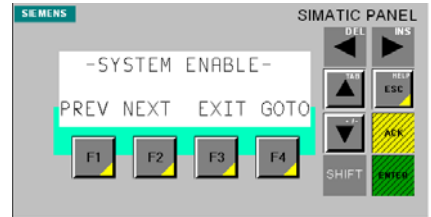

Fig 3

Note: To change a value scroll using the Up, Down, Left or Right arrow buttons to move to the desired value needing to be changed and then press Enter. Use the Up, Down, Left or Right arrow buttons to change the value. Press Enter to accept change.
Note: EXIT (F3) will bring you back to the System Enable Screen

SYS ENABLE (Fig 4)

This gives the ability to limit the operating hours of the Equipment Controller.

Day: Value of 0 specifies that the Equipment Controller is disabled for that day
Value of 1 specifies that the Equipment Controller is enabled for that day

Time: Specifies what hours on that day wet down is permitted to operate.

Value is in terms of minutes, ranging from 0-1440
(for example: 6:00AM-6:50AM = 360 to 410)

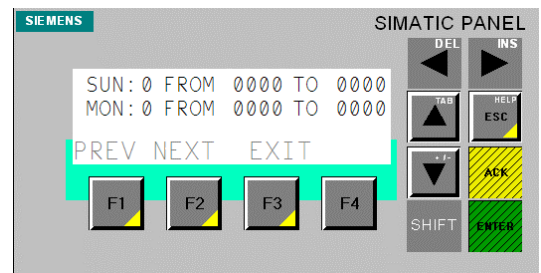

Fig 4

PLC CLOCK ADJUSTMENT

From Washlink Systems Start Screen (Fig1) press F4 (START)
 Scroll using F1 (PREV) and F2 (NEXT) to go to the System Config (Fig 2) Screen
 When at the System Config screen Press F4 (GOTO)
 Scroll using F1 (PREV) and F2 (NEXT) to go to the System Enable (Fig 3) Screen
 When at the Roller Raiser Config screen Press F4 (GOTO)
 Note: F3 (EXIT) to get back to Washlink Systems Start Screen

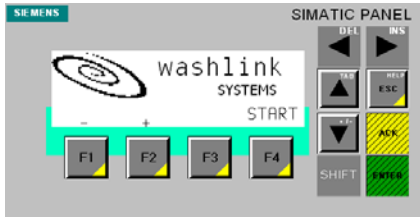

Fig 1

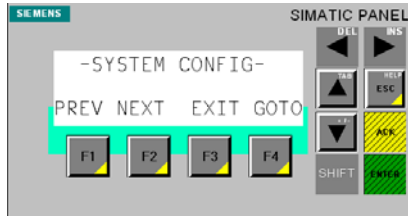

Fig 2

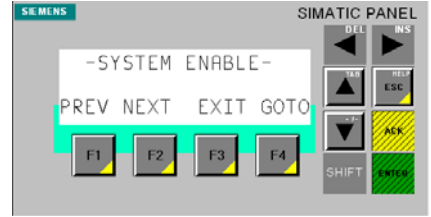

Fig 3

Note: To change a value scroll using the Up, Down, Left or Right arrow buttons to move to the desired value needing to be changed and then press Enter. Use the Up, Down, Left or Right arrow buttons to change the value. Press Enter to accept change.
 Note: EXIT (F3) will bring you back to the System Enable Screen

PLC Clock (Fig 4)

This gives the ability to adjust the PCL time of day clock and daylight savings.

To make a change:

- Change 0 to 1 in Adj field (puts into change mode)
- Scroll to field to adjust and press ENTER
- Arrow up/down/left/right to desired value and press ENTER
- Repeat as necessary on other fields
- After all fields have the value to be set,
- Change 1 to 2 in Adj field to accept changes

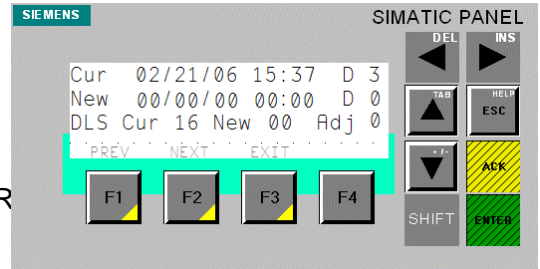

Fig 4

Cur=Current Date (mm/dd/yy), Time (hh:mm) 24hr format
 D=Day of the week
 1=Sunday, 2=Monday, 3=Tuesday, 4=Wednesday,
 5=Thursday, 6=Friday, 7=Saturday
 New=Adjusted Settings to be applied
 Adj=Clock Mode 0=normal, 1=change, 2=accept changes

DLS=Day Light Savings
 0=Not Used
 1=EU + 0 hrs
 2=EU + 1 hrs
 3=EU + 2 hrs
 8=EU - 1 hrs
 16=US
 17=Australia
 18=Australia (Tasmania)
 19=New Zealand

CRITICAL INPUT STATUS

From Washlink Systems Start Screen (Fig1) press F4 (START)

Scroll using F1 (PREV) and F2 (NEXT) to go to the Critical Input Status (Fig 2)

Note: F3 (EXIT) to get back to Washlink Systems Start Screen

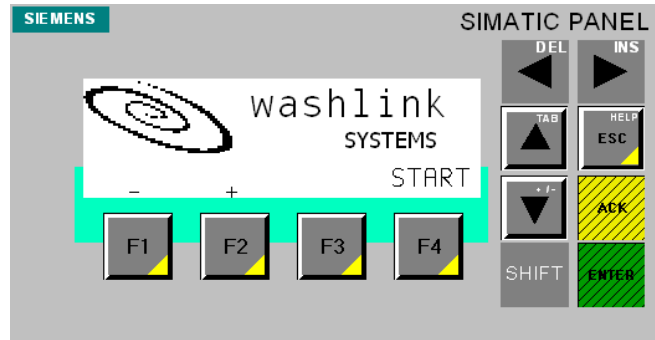

Fig 1

Stop Push Buttons
1=OK 2=Stopped
(all stop push buttons
need to be normally
Closed contacts)
If stops are a 0 system
will not operate.

Pulse Switch
This number will
be raising when
the conveyor is
running in auto
mode, count resets
at 99 to 0 or when
conveyor stops5

Hydraulic Low Level
1=OK 2=Stopped
(all hydraulic low level
switches, need to be
normally closed contacts)
If low levels are a 0 system
will not operate.

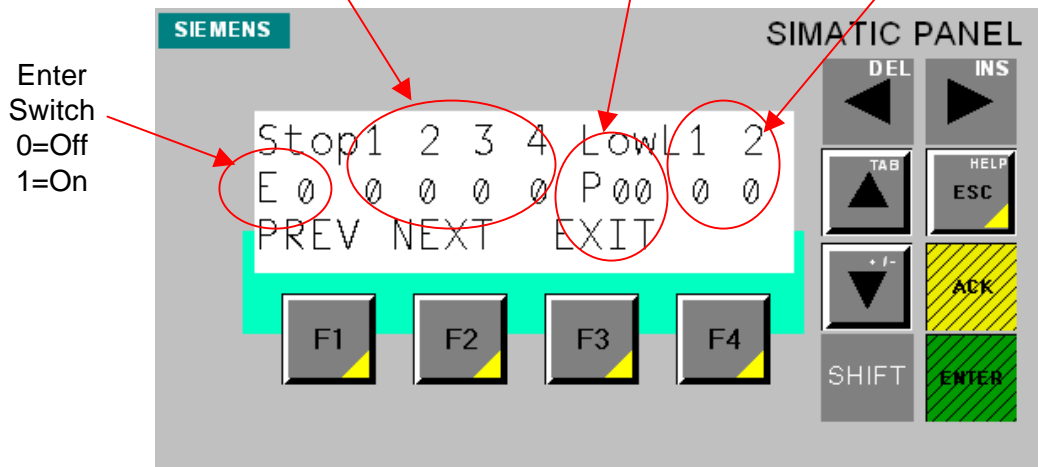

Fig 2

Settings

	Name	Location	Extension	Mode	Look back	From End	Conv.
4							
5							
6							
7							
8							
9							
10							
11							
12							
13							
14							
15							
16							
17							
18							
19							
20							
21							
22							
23							
24							
25							
26							
27							
28							
29							
30							
31							
32							

Settings

	Name	Location	Extension	Mode	Look back	From End	Conv.
33							
34							
35							
36							
37							
38							
39							
40							
41							
42							
43							
44							
45							
46							
47							
48							
49							
50							
51							
52							
53							
54							
55							
56							
57							
58							
59							
60							
61							
62							
63							
64							



Motor Control Center Stagger Start Controller

v1.0.1_jcc

Service Manual

Custom built for Jim Coleman Company / Hanna by:



Installation

Installation

Incoming Power

Model 230RC Apply 110vac power to L1 and N

Model 24RC Apply 24vac power to P1 & P2

Inputs

NOTE: Model 230RC use I1 for input power (110vac)

Model 24RC use P1 for input power (24vac)

I1 Start signal for Air Dryer Timer

I2 – I8 (also I1-I4 on expansion module) Not Used

Outputs

NOTE: All outputs are Normally Open Contacts 10amp Max.

Main Module

Q1 On Delay #1

Q2 On Delay #2

Q3 On Delay #3

Q4 On Delay #4

Expansion Module

Q1 On Delay #5

Q2 On Delay #6

Q3 On Delay #7

Q4 On Delay #8

Main Module Expansion Module

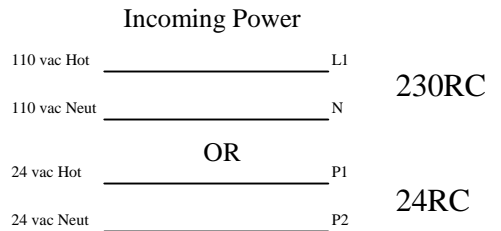
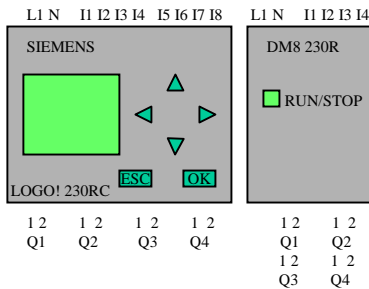

Output Wiring

Main Module



Expansion Module



Input Wiring

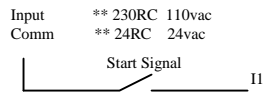

Programming Parameters

To get to programming mode press the ▼ button until the time and date message appear



Time
Date

When at the time and date message, Press the **ESC** button, and the following message will appear

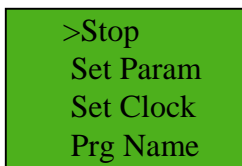

>Stop
Set Param
Set Clock
Prg Name

To Set Clock, use the ▼ button to Set Clock and press **OK** button
Use the ◀ ▶ ▼ ▲ buttons to move and set time and date, press **OK**

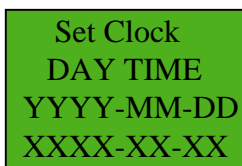

Set Clock
DAY TIME
YYYY-MM-DD
XXXX-XX-XX

Programming Parameters

To Set a on delay to the motors, use the ▼ button to Set Parm and press OK button
Use the ▼ ▲ buttons to move to AD 1 Dly through AD 8 Dly and, press OK

AD 1 Dly	←	Dryer motor to delay
T =XX:XXs	←	T= On Delay Time (s=seconds, m=minutes, h=hours)
Ta =XX:XXs		05:50s = 5-1/2 seconds

Use the ◀ ▶ ▼ ▲ buttons to move and set the On Delay time to start in
Seconds:1/100 of Seconds, press OK

To Set a extension to the motors, use the ▼ button to Set Parm and press OK button
Use the ▼ ▲ buttons to move to Off Dly and, press OK

Off Dly	←	Dryer on time extend
T =XX:XXs	←	T= On Delay Time (s=seconds, m=minutes, h=hours)
Ta =XX:XXs		05:50s = 5-1/2 seconds

Use the ◀ ▶ ▼ ▲ buttons to move and set the Off Dly time to extend the motors for
Seconds:1/100 of Seconds, press OK

To Exit the Programming Mode, press ESC Until the time and date message appears

Time Date

You can use the ▲ button to get back the count up screen or when it cycles, it
will automatically go back to the correct screen

Long Range Roller Detect Switch

This long range proximity switch will detect the roller assembly helping to eliminate roller jamming.



Mount with Supplied mounting bracket and 4 screws to existing take up slide carriage.

Wire as follows;

Terminal

- | | |
|---|---|
| 1 | 24 VDC (Supply power) |
| 2 | 0 VDC (Supply Power) |
| 3 | not used |
| 4 | 0 VDC to detect input (washlink equipment controller input 3) |
| 5 | not used |



Entrance Touch Screen EC520M

v1.0.1_jcc

Service Manual

Custom built for Jim Coleman Company / Hanna by:



Operation:

To process a car do the following:

- 1 Press the Start Button (unless conveyor is running, if so the Start Button will change to the Stop Button)
- 2 Press the correct Package Button (in Standard Mode) or Process Car Button (in Stacker Mode)
- 3 Chose Option Buttons (if any necessary)

For Wet Down or to change operating modes press Other

Standard Main Screen

Start/Stop Button

Note: will change to show hydraulic low level, collision alert, E-Stop or not in operating hours

Extra Roller Button

Roller Cancel Button
(used when in Auto roller up mode)

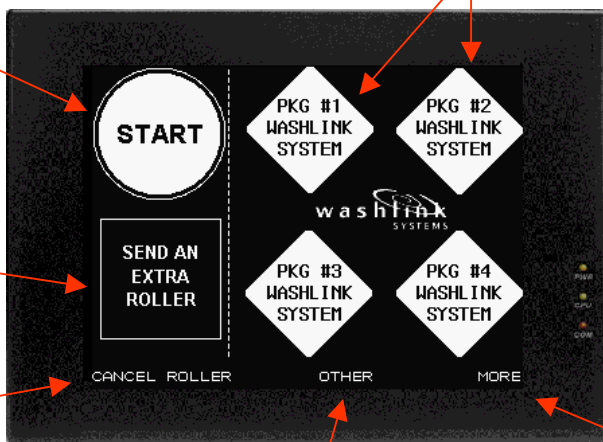

Package Buttons (16 available)
Can be re-labeled in Programming mode

PWR Light

CPU Light

COM Light

All should be on during normal operation

More Button

To toggle to next page of wash packages

Other Button

To get to wet down screen, Stacker mode and Programming Mode

Stacker Main Screen

Start/Stop Button

Note: will change to show hydraulic low level, collision alert, E-Stop or not in operating hours

Extra Roller Button

Roller Cancel Button
(used when in Auto roller up mode)

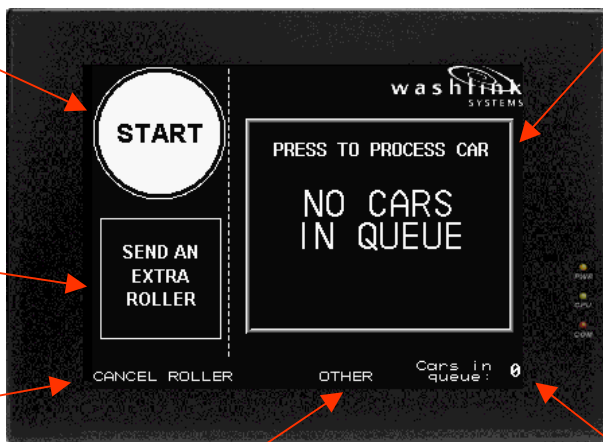

Process Car Button

Shows wash package for Current car to process

PWR Light

CPU Light

COM Light

All should be on during normal operation

Cars in Queue

Shows current number of cars in queue
When pressed will allow removal of next car or all cars from the queue

Other Button

To get to wet down screen, Standard mode and Programming Mode

Operation:

Option Screen

Start/Stop Button

Note: will change to show hydraulic low level, collision alert, E-Stop or not in operating hours

Option Buttons

Pressing toggles between No or Yes for the option
To be on the current car
Can be re-labeled in Programming Mode



Clear Button

clears current car package
Count Down Timer
Time until screen switches back to main screen

PWR Light

CPU Light

COM Light

All should be on during normal operation

More Options

To toggle to next page of options



Clear Car from Queue Screen

Extra Roller Sent Screen

Wet Down/Program Screen

Wet Down Sent Screen

Change between Standard & Stacker Mode

Standard Operation Main Screen Stacker Operation Main Screen

- 1 Press "Other" on Main Screen (fig 1&2)
- 2 Press "*****" (Password Window) (fig 3)
- 3 Enter Password "12345" (fig 4)
- 4 Press "ENT" to Enter (fig 4)
- 5 Press "Standard" or "Stacker" (fig 5) to finish

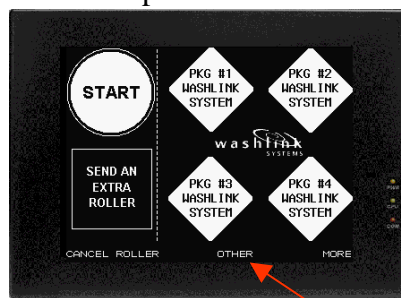

Fig 1

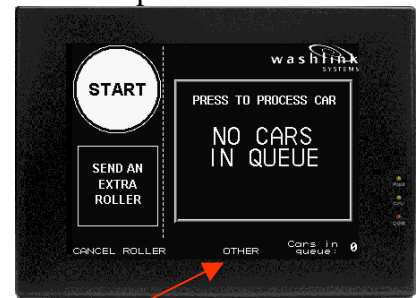

Fig 2

Other Button

Password Screen

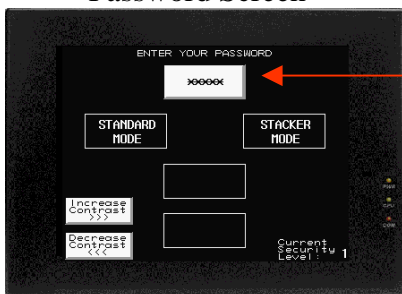

Fig 3

Password Window

Enter Password Screen

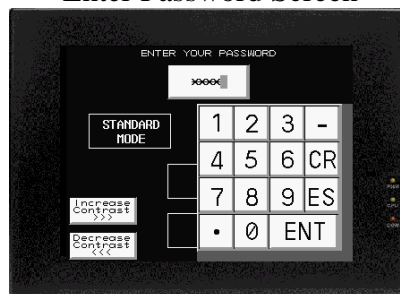

Fig 4

Standard/Stacker Screen

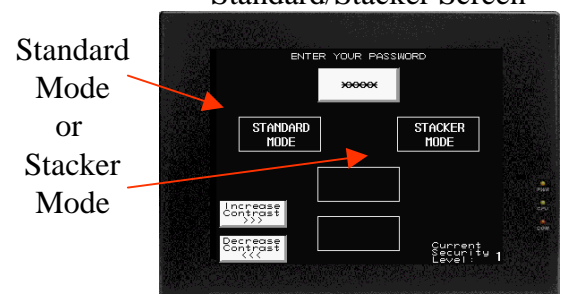

Fig 5

Standard Mode or Stacker Mode

Programming:

Change Package & Option Name Screen

- 1 Press "Other" on Bottom of Main Screen (fig 1 & fig 2)
- 2 Press "Stacker" or "Standard" on Bottom of Other Screen (fig 3)
- 3 Press "*****" Password Window (fig 4)
- 4 Enter "95125" Password (fig 5)
- 5 Press "ENT" Enter (fig 5)
- 6 Press "Change Label" (fig 6)
- 7 Press the box of the package or option name to change, or scroll to other screen
 - Each Package name has 3 lines. (fig 7)
 - First line 6 characters. Second line 8 characters. Third line 6 characters.
 - Each Option name has 2 lines. (fig 8)
 - First line 8 characters. Second line 8 characters.
- 8 Type in new information and press Enter after each line (fig 9)
- Note: If enter not pressed information will be lost!**
- 9 When finished, press Standard or Stacker (fig 7 & fig 8)
- 10 Repeat for each Label to be changed

Standard Operation Main Screen

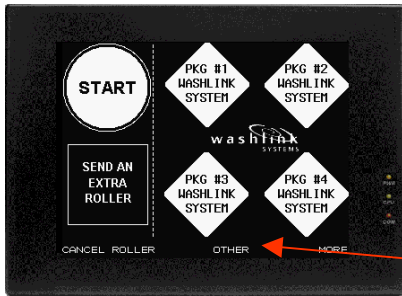

Fig 1

Stacker Operation Main Screen



Fig 2

Other Screen



Fig 3

Password Screen

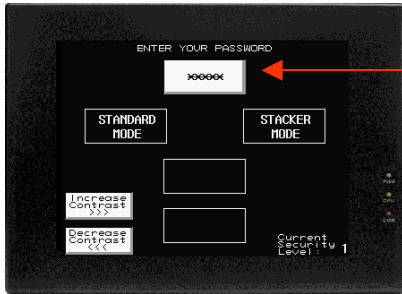

Fig 4

Enter Password Screen



Fig 5

Mode & Change Screen

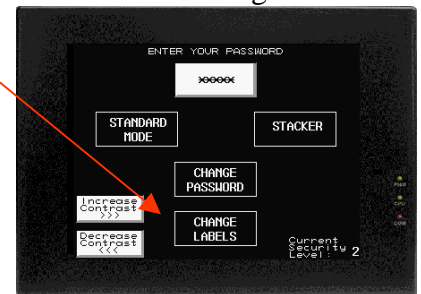

Fig 6

Package Label Screen

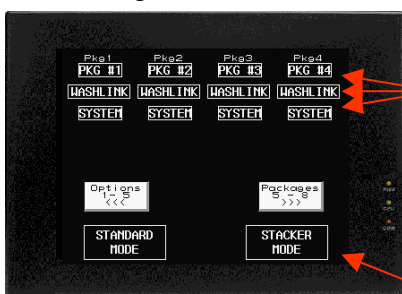

Fig 7

Option Label Screen

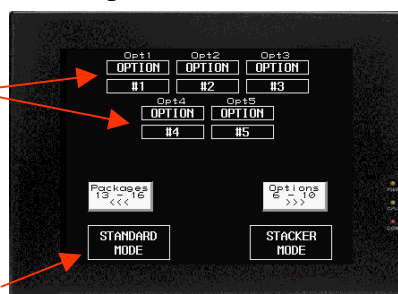

Fig 8

Label Keyboard Screen

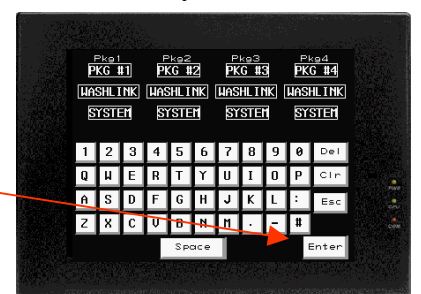

Fig 9

Other Button

Standard or Stacker Button

Password Window

Change Label Button

Labels

Standard or Stacker Button

Enter Button

Installation:

Maple Touch Screen
Female DB9 Connector

Siemens S7-200 PLC
Male DB9 Connector

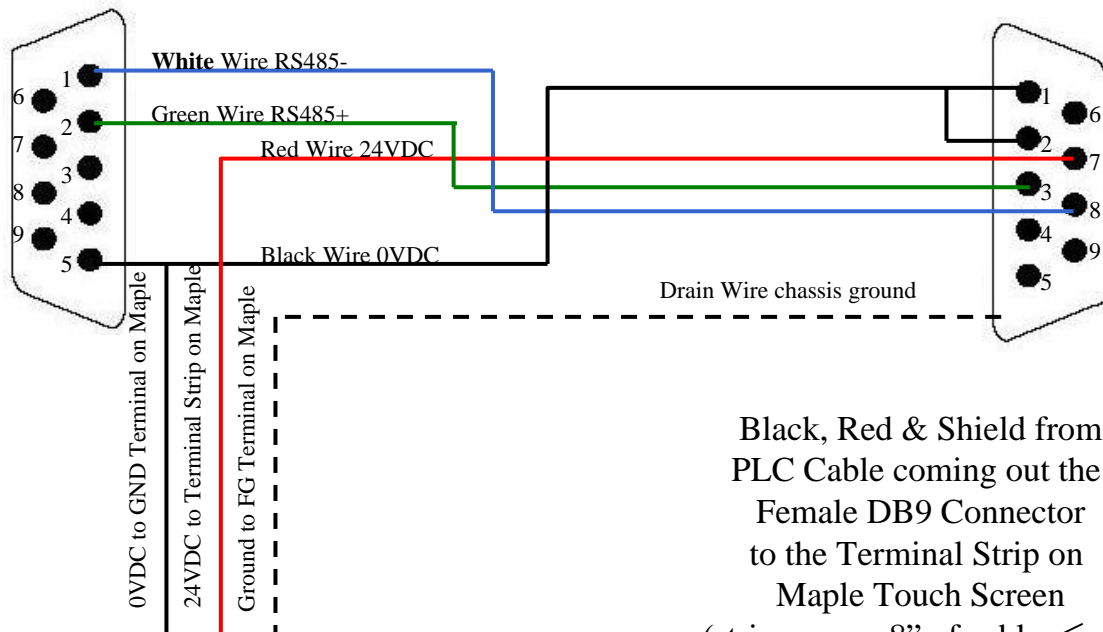

Black, Red & Shield from PLC Cable coming out the Female DB9 Connector to the Terminal Strip on Maple Touch Screen (strip approx 8" of cable cover)

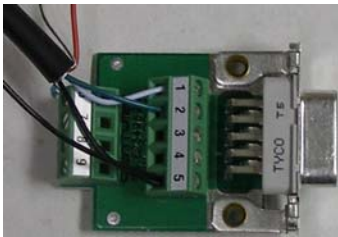

Connections in Female DB9 connector on Touch Screen

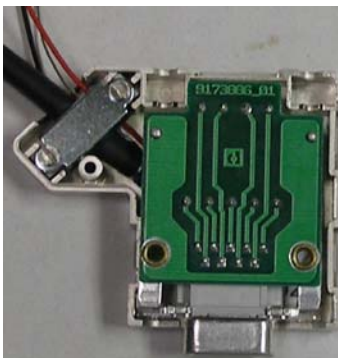

Cable & power wires clamped inside of Female DB9 connector on Touch Screen (note: direction of connector)

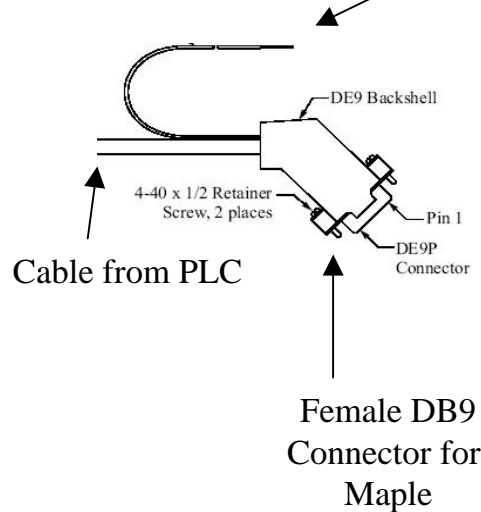

Power wires from Female DB9 connector to terminal strip on Touch Screen



Collision Avoidance Controller

v2.0.3_jcc

Service Manual

Custom built for Jim Coleman Company / Hanna by:

washlink
SYSTEMS

This page is intentionally left blank.

LOOP WIRE INSTALLATION

Dear Installer,

You may have installed loops for some time. Or, you may be just starting out. In any case, it is good to refresh our memory and maybe learn some new tricks.

First, remember that the loop is an integral part of the detector electronic circuitry. We, the loop detector manufacturers entrust you with making a very important electronic part of our loop detector.

Materials used in the construction of the loop are important. The loop wire should be 16 gage stranded tinned copper wire with cross-linked polyethylene (XLPE) insulation rated for 600V. By using this wire you get the following advantages.

- a. The wire gage is large enough so the serial resistance of the loop is low.
- b. The wire is flexible enough to work with in the saw cut, minimizing the possibility of a damage to the insulation.
- c. The XLPE insulation has increased moisture and solvent resistance, and superb aging characteristics. Moisture and solvents in the black top pavement or oil spills from the cars are the major causes in long term insulation damage that causes intermittent loop lockups and false detection.

Note: The standard THHN wire so popular with installers it is designed for the following applications:

An all around general purpose building wire, for fixture raceways, conduit and tubing raceways, internal wiring of fixtures and applications requiring building wire.

Please note that the THHN wire was designed for conduit applications. It sometimes has a

very thin sheeting of nylon, which protects it from moisture, but it is easily damaged during wire installation in the saw cut.

Sealant: Use only a commercial type of loop sealant designed for traffic loops. Any other material will not work for a long time.

Backer Rod: Use a backer rod to ensure that the wires are in place and do not vibrate under the backer rod. Any vibration of wire movement will cause a false detection.

We have the materials covered so lets discuss the wire installation. The purpose of all the installation rules that you may have read or heard about is very simple. We want you to construct a wire coil in the pavement that will comply with the following:

- a. The loop wire insulation will be intact for a long period of time after you have sealed it in the pavement.
- b. The loop wire will not move or vibrate in the pavement.
- c. The loop wire will be away from any electrical noise.
- d. The loop wire will be away from any moving metal you do not want to detect.
- e. The loop wire continuity (or serial resistance) will be low and constant.

LET'S EXPAND ON THESE FIVE PARTS

a. The wire insulation is very important in preventing a false detection and detector lock-ups. So any scratches on the wire insulation, sharp edges or small stones in the saw cut, and sharp tools used during the installation will cause damage to the wire.

Good Insulation = No Call Back

b. Any vibration of the loop wires or movement of the steel mesh underneath the loop will cause false detection. Before loop installation, inspect the pavement. If the chosen area has large cracks in the pavement and evidence of pavement movement, there is a potential problem. Parts of the pavement may move after you have installed the loop and damage the wire, or cause false detection. Use the backer rod to make sure that the wire is held firm in the saw cut.

No Wire Vibration and Good Pavement = No Call Back

c. If you have a power line running under the loop wire do not be surprised if you get false detects. The changes in electrical currents are detected by the loop detector as cars.

No Power Lines Close to the Loop = No Call Back

d. If you have a metal slide gate or a metal overhead door close to the loop, the detector will detect it. The detector cannot distinguish between the metal in the gate and the metal in the car.

No Moving Metal Close to the Loop = No Call Back

e. Wire nut as a splice connection is great when dealing with mains. However, when you have to make a splice on the lead-in wire use a solder iron. The current on the loop wire is too low to overcome the long term oxidation occurring on a wire nut connection.

Soldered Splices = No Call Back

IN SUMMARY

The following elements can reduce the loop detector sensitivity:

a. Underground steel reinforcing – make the loop cut shallow in concrete pavement. (approx. 1 inch) or use fiberglass mesh when

installing new concrete pavement.

b. More than one loop connected to one detector – if you are experiencing a low sensitivity problem and you have two loops on one detector, consider adding an additional loop detector. Two loops on one detector = half the sensitivity.

The following elements can cause detector lock up or intermittent detection:

a. Cross-talk between adjacent loops due to both having the same operating frequency – use the LD-2000 loop detector frequency counter feature to measure the loop frequency.

b. Inadequate loop spacing – keep loops four feet apart

c. Loop wire vibration in the saw cut – use backer rod

d. Splices with wire cut – solder all splices

e. Lead-in wires not twisted – twist lead-in wire at least six turns per foot

f. Power lines close to the loop – keep at least six feet away from power lines

g. Loop too close to moving gate – keep at least four feet away

NOTE: Always connect safety loops in series, free exit can be connected in parallel.

Use automatic sensitivity boost to detect high bed vehicles. Use the filter function to filter out RF noise generated by police and EMS vehicles.

Use fail safe detector for safety and fail secure detector for free exit application.

SHORTCUT: You can avoid installation problems and guess work by simply installing a well constructed preformed loop like our EMX Lite Loop.

Features

Features of Washlink Systems Anti Collision Controller;

The ability to use input device of choice, eyes, loop, wands etc.

Industry proven components from Siemens Worldwide

Built in car counter for added security

External reset button

Warning isolation relay for any external device, horn, light etc.

Equipment auto re-start on isolation relay for use with any voltage

Equipment auto stop on isolation relay for use with any voltage

Go/Exit light control

Cycle counter for maintenance purposes

Battery back up of real-time clock

Installation

Installation

Mount Anti Collision Controller Box

Incoming Power

Apply 110vac power to L1 and N (upper left)

Input #1 Sensor

If using inductive loops, hook up loop wires to #7 & #8 on appropriate relay socket

If using photo eyes, hook up eye wires to #5, #6, #7 & #8 on appropriate relay socket

If using external signal, 2 wires from normally open contact to terminal #149 & #150

Input #2 Sensor

If using inductive loops, hook up loop wires to #7 & #8 on appropriate relay socket

If using photo eyes, hook up eye wires to #5, #6, #7 & #8 on appropriate relay socket

If using external signal, 2 wires from normally open contact to terminal #149 & #150

Stop Controls

Run two wires in series with the stop circuit and hook up to terminal #141 & #142

Note: This is a normally closed contact, use existing stop power

Start Controls

Run two wires parallel with the start circuit and hook up to terminal #143 & #144

Note: This is a normally open contact, use existing start power

Horn Controls

Run two wires parallel with the horn circuit and hook up to terminal #145 & #146

Note: This is a normally open contact, use existing horn power

Go/Exit Light Controls

Run two wires parallel with the light circuit and hook up to terminal #147 & #148

Note: This is a normally open contact, use existing light power

Input and Output Definitions

Inputs

NOTE: Inputs are 110vac, use same power that goes to L1

I1 Collision Input #1 (Loop, Eye, Wand Etc.)

I2 Collision Input #1 (Loop, Eye, Wand Etc.)

I3, I4, I5, I6, I7 Future

I8 Counter Reset

Outputs

NOTE: All outputs are Normally Open Contacts 10amp Max.

Q1 is for Stop Relay

Q2 is for Start Relay

Q3 is for Horn Relay

Q4 is for Go/Exit Light Relay

View Settings and Counts

During normal operation the following messages will be displayed depending on the status on the controller

TOTAL CAR
COUNT XX
Resets to 0
At 1000000

COLLISION
SENSOR ONE
ACTIVATED

COLLISION
SENSOR TWO
ACTIVATED

COLLISION
SENSORS
ONE AND TWO
ACTIVATED

CONVEYOR
STOPED FOR
COLLISION
AVOIDANCE

GO LIGHT
ACTIVATED

To view Car Counts, use the ▼ button to the following message
To clear counts momentarily apply power (L1) to Input I8.

TOTAL CAR
COUNT XX
Resets to 0
At 1000000

Programming Mode

To get to programming mode, press the  button until the time and date message appear



Time
Date

When at the time and date message, press the  button, and the following message will appear

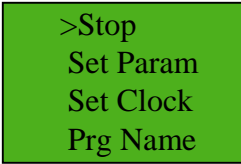

>Stop
Set Param
Set Clock
Prg Name

To Set Clock, use the  button to Set Clock and press  button
Use the     buttons to move and set time and date, press 

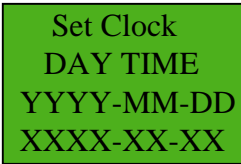

Set Clock
DAY TIME
YYYY-MM-DD
XXXX-XX-XX

Programming Go/Exit Light

The Go/Exit light function operates once each time the #2 sensor is activated
There are two settings;

- First, how much time after sensor #2 was activated
- Second, how long to stay

While in Programming Mode

To set how much time after sensor #2 to turn the light on, use the ▼ button to set Parm and press **OK** button.

Use the ▼ ▲ buttons to move to On Delay and, press **OK**

```
Go_Light
TH =XX:XXm
TL =XX:XXm
Ta =XX:XXm
```

Use the ◀ ▶ ▼ ▲ buttons to move and set the On Delay (TH) and On Time (TL) Minutes:Seconds, press **OK**

Programming On Delay for Sensors

To Set a on delay to the sensors, use the ▼ button to Set Parm and press **OK** button
Use the ▼ ▲ buttons to move to #1_Delay or #2 Delay and, press **OK**

```
#1_Delay
T =XX:XXs
Ta =XX:XXs
```

```
#2_Delay
T =XX:XXs
Ta =XX:XXs
```

Use the ◀ ▶ ▼ ▲ buttons to move and set the On Delay time to start in Seconds:1/100 of Seconds, press **OK**

To Exit the Programming Mode, press **ESC** Until the time and date message appears

```
Time
Date
```

You can use the ▲ button to get back the count up screen or when it cycles, it will automatically go back to the correct screen

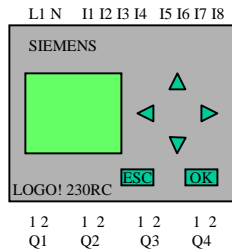

R1 Stop

R2 Start

R3 Horn

R4 Light

Max Torque
Fuse Holders
20 in lbs

Terminals
7 in lbs

 Reset Push Button
(on outside of box)



120VAC
Fuse mdl3

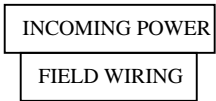

141 142
Stop N.C. Dry Contact
Wire in series with stop circuit



143 144
Start N.O. Dry Contact
Wire parallel with start circuit



145 146
Horn N.O. Dry Contact
Wire parallel with horn circuit



147 148
Light N.O. Dry Contact
Wire parallel with light circuit



91 92
120vac
Photo Eye Emitter



93 94 95
120vac
Photo Eye Receiver



Wire loop to
#7 & #8

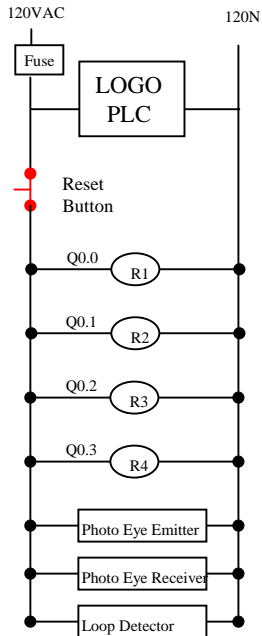

Outputs

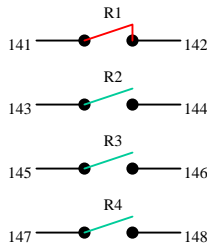

Inputs

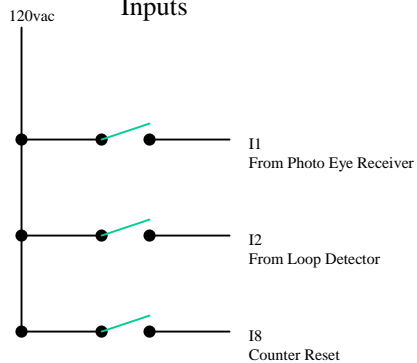

Washlink Systems, San Jose, CA 408-928-0808
Panel Drawing Anti-Collision Banner/Loop
Supply Voltage 115vac
Frequency 50/60 HZ
Power Consumption 2amp@120vac

Disconnect and branch circuit protection, Max 20amp
listed circuit breaker, to be provided by installer
Use only copper conductors with 60°C rating or above

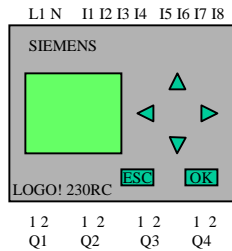

R1 Stop

R2 Start

R3 Horn

R4 Light

Max Torque Fuse Holders 20 in lbs
Terminals 7 in lbs

Reset Push Button (on outside of box)

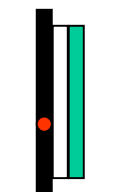

120VAC Fuse mdl3

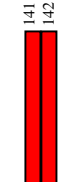
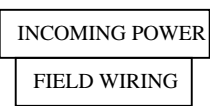

Stop N.C. Dry Contact
Wire in series with stop circuit

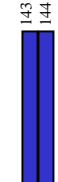

Start N.O. Dry Contact
Wire parallel with start circuit

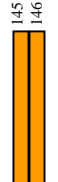

Horn N.O. Dry Contact
Wire parallel with horn circuit

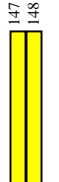

Light N.O. Dry Contact
Wire parallel with light circuit

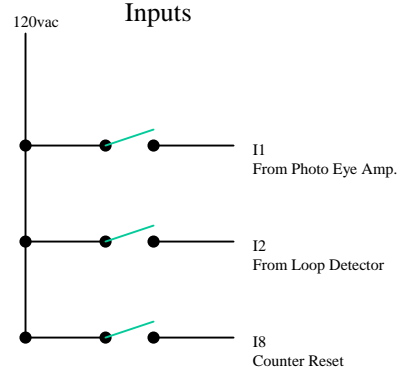
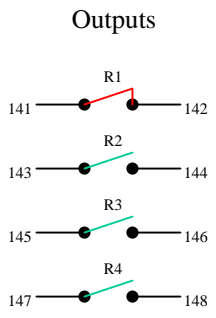
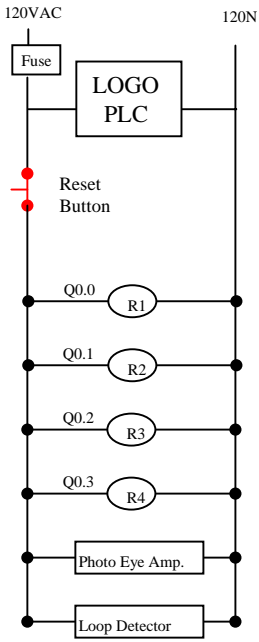
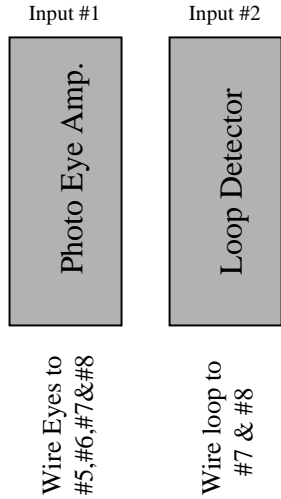

Washlink Systems, San Jose, CA 408-928-0808
Panel Drawing Anti-Collision Logo Eye/Loop
Supply Voltage 115vac
Frequency 50/60 HZ
Power Consumption 2amp@120vac

Disconnect and branch circuit protection, Max 20amp listed circuit breaker, to be provided by installer
Use only copper conductors with 60°C rating or above

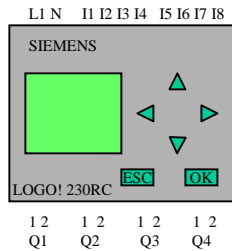

R1 Stop

R2 Start

R3 Horn

R4 Light

Max Torque
Fuse Holders
20 in lbs

Terminals
7 in lbs

Reset Push Button
(on outside of box)



120VAC
Fuse mdl3

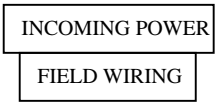

Stop N.C. Dry Contact
Wire in series with stop circuit



Start N.O. Dry Contact
Wire parallel with start circuit



Horn N.O. Dry Contact
Wire parallel with horn circuit



Light N.O. Dry Contact
Wire parallel with light circuit

Input #1



Signal for Input #1 from
Car Wash Controller

Use N.O. dry contact Only

Input #2



Wire loop to
#7 & #8

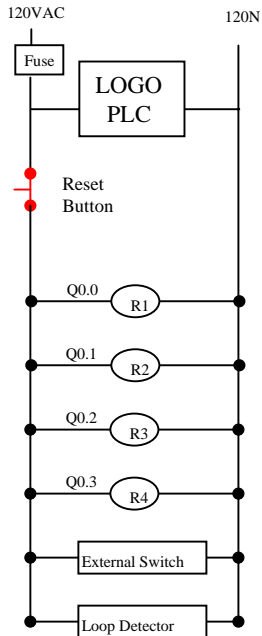

Outputs

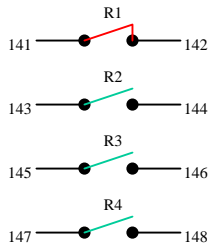

120vac Inputs

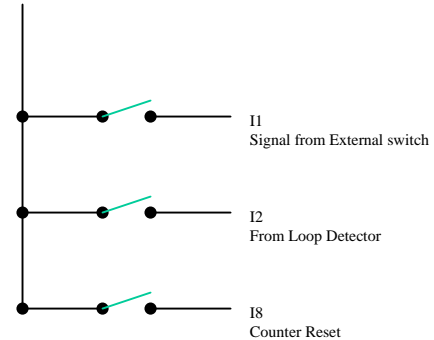

Washlink Systems, San Jose, CA 408-928-0808
 Panel Drawing Anti-Collision Logo 1 Loop
 Supply Voltage 115vac
 Frequency 50/60 HZ
 Power Consumption 2amp@120vac

Disconnect and branch circuit protection, Max 20amp
 listed circuit breaker, to be provided by installer
 Use only copper conductors with 60°C rating or above

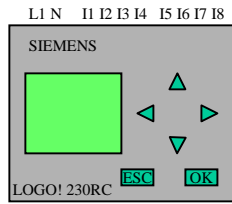

L1 N I1 I2 I3 I4 I5 I6 I7 I8
 Q1 Q2 Q3 Q4

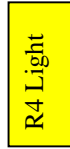

Max Torque
 Fuse Holders
 20 in lbs
 Terminals
 7 in lbs

 Reset Push Button
 (on outside of box)



120VAC
 Fuse mdl3

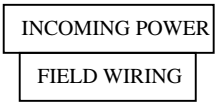

141 142
 Stop N.C. Dry Contact
 Wire in series with stop circuit



143 144
 Start N.O. Dry Contact
 Wire parallel with start circuit



145 146
 Horn N.O. Dry Contact
 Wire parallel with horn circuit



147 148
 Light N.O. Dry Contact
 Wire parallel with light circuit

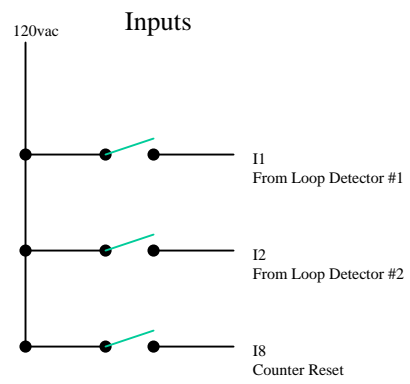
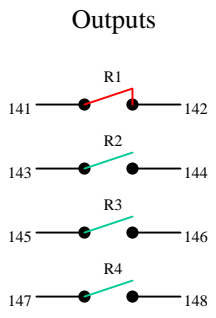
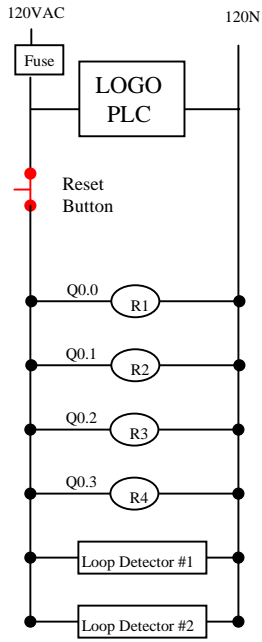
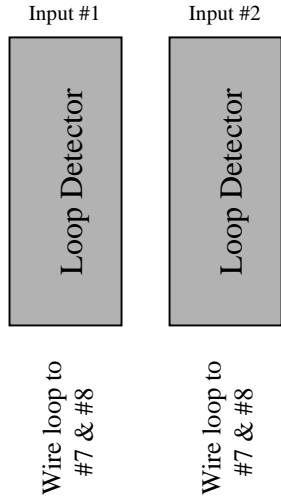

Washlink Systems, San Jose, CA 408-928-0808
 Panel Drawing Anti-Collision Logo 2 Loop
 Supply Voltage 115vac
 Frequency 50/60 HZ
 Power Consumption 2amp@120vac

Disconnect and branch circuit protection, Max 20amp listed circuit breaker, to be provided by installer
 Use only copper conductors with 60°C rating or above

These dimensions are only for reference.

**To increase the distance between cars before stoppage of conveyor, increase the distance between sensor locations.
To shorten the distance between cars before stoppage of conveyor, decrease the distance between sensor locations.**

Eye & Loop System

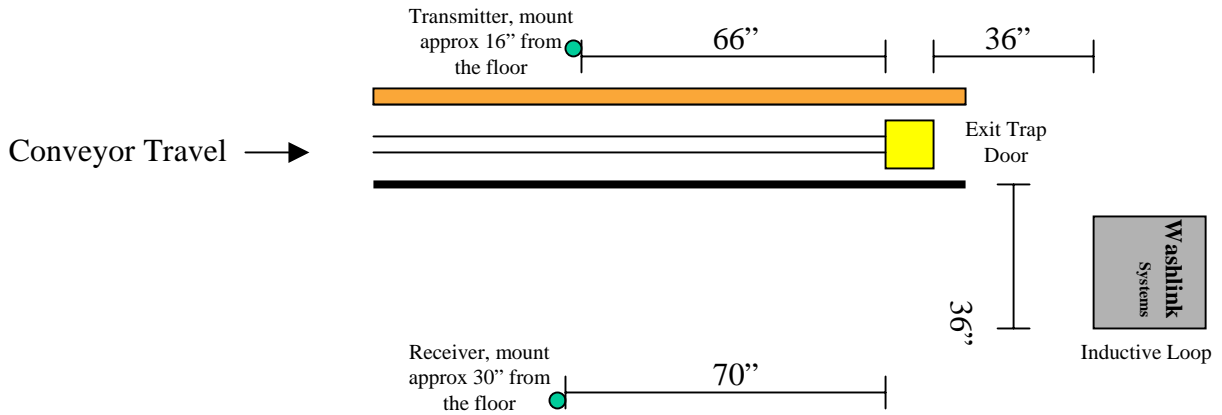

Two Loop System

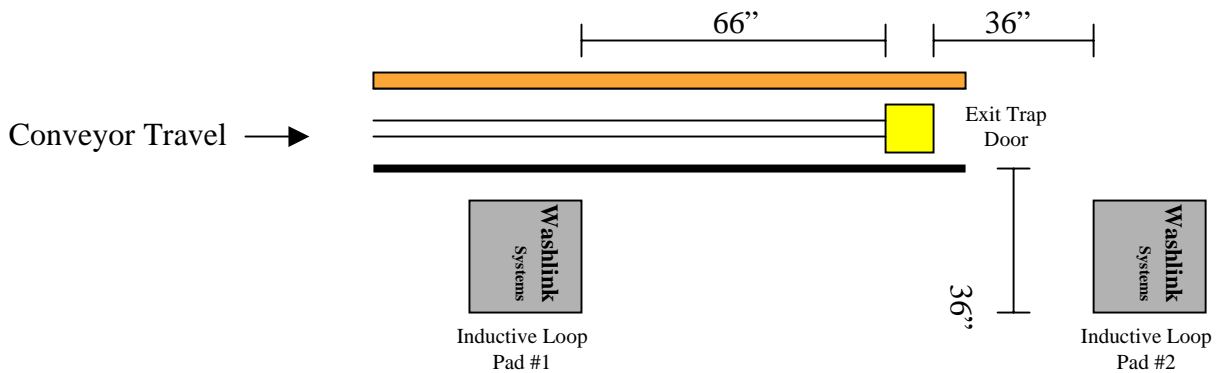

One Loop System

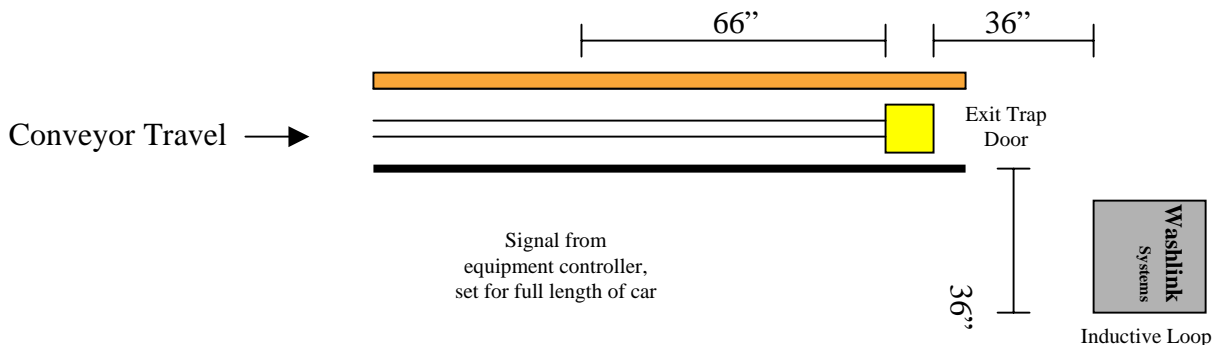

This page is intentionally left blank.



Jim Coleman Company/Hanna Car Wash Systems

Main Office

5842 West 34th Street
Houston, TX 77092

800-999-9878 • 713-683-9878 • Fax: 713-683-9624
www.jcolemanco.com

Hanna Division Office

7905 Blankenship Dr.
Houston, TX 77055

866-683-6615 • 713-683-6615 • Fax: 713-590-6630
www.hannacarwash.com



Auto Roller Raiser Controller

v1.0.1_jcc

Service Manual

Custom built for Jim Coleman Company / Hanna by:

washlink
SYSTEMS

Features

Features of Washlink Systems Auto Roller Raiser Controller;

Automatically call up rollers when vehicle enters conveyor

Front wheel pull or rear wheel pull

Choose number of rollers to raise

Use with or without roller detect switch or not

Manual roller button input

Manual roller cancel input

Auto Conveyor Start

Entrance Light Control

Force roller up output for testing

Cycle counter for maintenance purposes

Information and status on display

Battery back up

Installation

Installation

Incoming Power

Model 230RC Apply 110vac power to L1 and N

Model 24RC Apply 24vac power to P1 & P2

Inputs

NOTE: Model 230RC use LI for input power (110vac)

Model 24RC use P1 for input power (24vac)

- I1 Tire Detect Switch (also detects rollers up on conveyor)
- I2 Roller Detect Switch (if used, if not I4 must be high)
- I3 Conveyor on (this input must be on for system to work)
- I4 No Detect Switch Used (if no detect used must be high)
- I5 Roller Up Button
- I6 Roller Cancel Button
- I7 System Enable (this input must be on for system to work)
- I8 Cycle Count Reset (apply momentary power to input to clear count)

Outputs

NOTE: All outputs are Normally Open Contacts 10amp Max.

- Q1 Roller Raiser Valve
- Q2 Conveyor Start (if used)
- Q3 Roller Up Controlled Sign (if used)
- Q4 Future

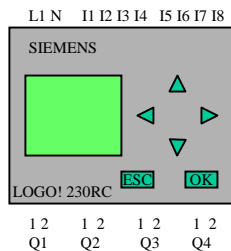

Output Wiring

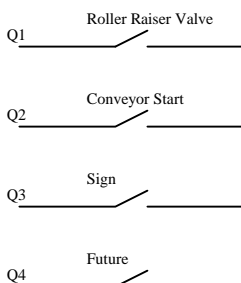

Incoming Power

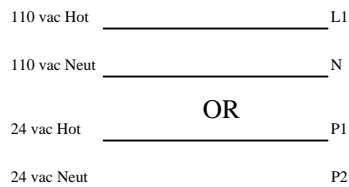

230RC

24RC

Input Wiring

Input ** 230RC 110vac
Comm ** 24RC 24vac

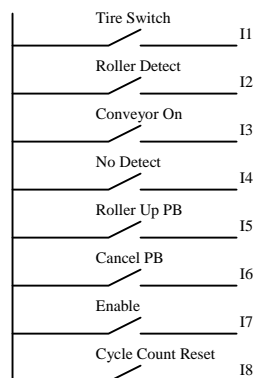

Installation of Banner Eyes

Installation of Banner Eyes on Conveyor

Make a 1-1/2" hole on both conveyor rails clear of the trap door (approx. 4"-6" past) at approx. 2"-3" up from the conveyor top deck.

Mount eyes and protect as necessary

Wire Blue leads to the neutral side of the power

Wire Brown leads to input common

Wire Black lead to Input 1

NOTE: When power is on to eyes, the green light will be on

When the eyes are aligned the yellow light on the Receiver will be on

If the yellow light is not on, the eyes are being blocked, dirty, misaligned or damaged

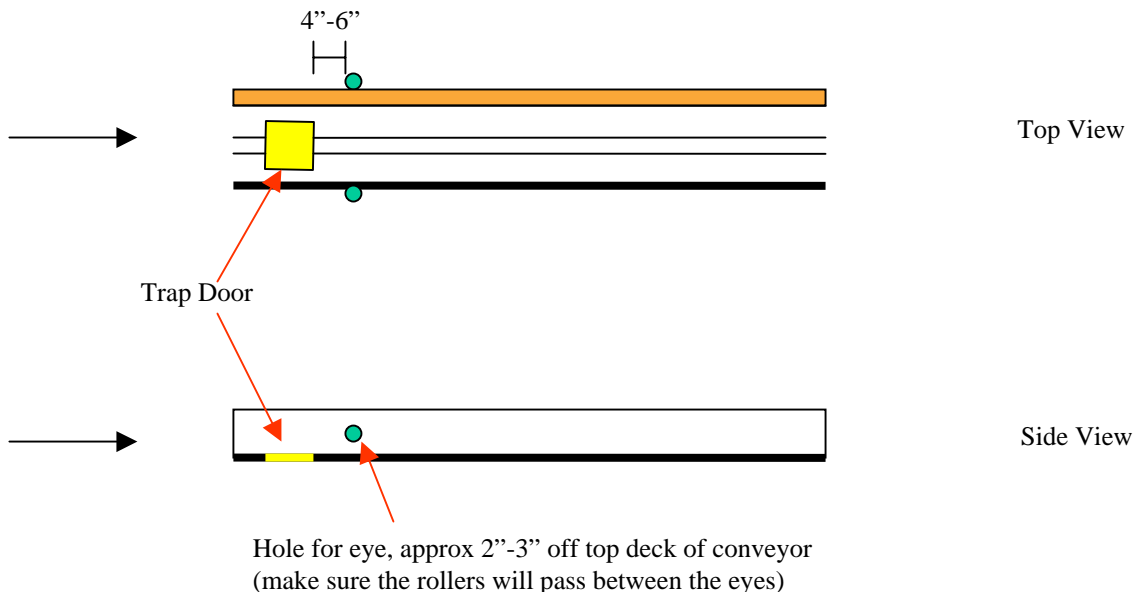

View Settings and Counts

During normal operation the following messages will be displayed depending on the status on the controller

NUMBER OF
TIRES/ROLLERS
DETECTED
X

ROLLER
DETECT
ACTIVATED
OR STUCK

TIRE
SWITCH
ACTIVATED
OR STUCK

To view Cycle counts, us the ▼ button to the following message
To clear counts momentarily apply power (L1 or P1) to Input I8.

ROLLER CYCLE
COUNT XX
Resets to 0
At 1000000

Warning Messages

Message	Cause	Remedy
<p>TIRE SWITCH ACTIVATED OR STUCK</p>	<p>Input I1 is on, if conveyor is running and this message is always on, switch is stuck or damaged</p>	<p>Clean, repair or replace Tire detect switch</p>
<p>ROLLER DETECT ACTIVATED OR STUCK</p>	<p>Input I2 is on, if conveyor is running and this message is always on, switch is stuck or damaged</p>	<p>Clean, repair or replace Tire detect switch</p>

Programming Parameters

To get to programming mode press the ▼ button until the time and date message appear



Time
Date

When at the time and date message, Press the **ESC** button, and the following message will appear

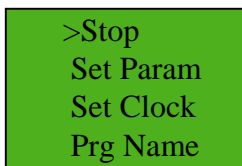

>Stop
Set Param
Set Clock
Prg Name

To Set Clock, use the ▼ button to Set Clock and press **OK** button
Use the ◀ ▶ ▼ ▲ buttons to move and set time and date, press **OK**

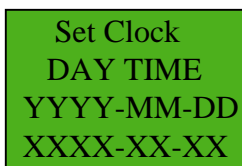

Set Clock
DAY TIME
YYYY-MM-DD
XXXX-XX-XX

Programming Parameters

To Set how many tires to start a Cycle, use the ▼ button to Set Param and press OK button
Use the ▼ ▲ buttons to move to # of Tires and, press OK

Tire_#up	
On #	X
Off#	X
Cnt#	X

NOTE:

On = Number of tires needed to activate roller up
Off = Number of rollers to raise plus number of tires
if 2 tires to activate and 2 rollers are wanted
settings will be as follows,

On#	2
Off#	4

To Exit the Programming Mode, press ESC Until the time and date message appears

Time
Date

You can use the ▲ button to get back the count up screen or when it cycles, it
Will automatically go back to the correct screen