



OPTIMA

Operations Manual

VIRTUAL ATTENDANT



**COLEMAN
HANNA**
CARWASH SYSTEMS LLC

AN O'HANRAHAN COLEMAN COMPANY

5842 W 34th St, Houston, TX 77092
1.800.999.9878 • 1.713.683.9878
www.colemanhanna.com



Find us on Facebook:
[/ColemanHannaCarwash](https://www.facebook.com/ColemanHannaCarwash)

Optiva



PREFACE

Congratulations! You have just purchased one of the most revolutionary entrance controller/coin boxes on the market today. The Optiva is a reflection of the way Optiva LLC approaches the customer's needs. Reliability, functionality, and economics played heavily on the design of the OPTIVA. Many things were learned from the design of our other product, the Entry Wizard. Much of the functionality of the Optiva comes from its predecessor as Optiva LLC learned the needs and wants of the operator and end user alike. We feel that you will see the Optiva to be superior to other designs on the market because of its simple design, economical operation, and adaptability to many rollover and brush washes available. Buying from Coleman Hanna Car Wash systems gives you not only a great product, but a company that has established itself in the market place by treating all of its customers fair and equally. The full line of equipment that Coleman Hanna offers, integrates, in a seamless fashion with the Optiva. Below are a few of the features you have purchased:

- Stainless Steel Cabinet
- Mars Bill Acceptor (\$1, \$5, \$10, \$20)
- Micro Coin UL Coin Acceptor (\$.25, \$1.00, Token(s))
- Neuron Credit Card Swipe
- Sunlight Readable Display
- Heavy Duty Wash Selection Buttons
- Nema 4 Keypad
- Visual Instruction as well as Written
- POS 4000 Ready
- High Security Door
- Medico Locks
- Colorful Decal

Coleman Hanna Car wash systems wishes to thank you for your purchase and hopes it meets or exceeds your expectations.

COPYRIGHTS AND DISCLAIMERS

The OPTIVA are designed equipment and software for interfacing with a new or existing carwash providing credit card, code, and/or cash acceptance for the operation of carwash equipment. It is completely developed and designed by the Optiva LLC. Any un-authorized use of it is strictly forbidden without written permission from the Optiva LLC. No alteration of its systems or their operating procedures is allowed. For more information concerning this system contact:

Coleman Hanna Car wash systems LLC
5842 West 34th
Houston, Texas 77092
Tel: (713) 683-9878
Toll Free: (800) 999-9878
Fax: (713) 683-9624
E-Mail: info@jcolemanco.com
Website: www.colemanhanna.com

LIMITED WARRANTY

The Manufacturer warrants any component or part of the Optiva equipment to be free from defects in material and workmanship for a period of one (1) year from date of shipment, with the exception of such parts as are commonly recognized to be subject to wear in normal usage. Such as:

Locks, Acceptor Belts, Bearings, and Rollers

However, should any defects in material and/or workmanship appear within the first ninety (90) days of this one (1) year period, Coleman Hanna Car wash systems shall, upon notification, correct such defects in materials and/or workmanship. Defects will be corrected at company's option, either by repairing defective equipment or parts or by replacing defective equipment or parts. During this first ninety (90) day period, Coleman Hanna or its distributor shall be responsible only for parts and labor. Purchaser shall be responsible for any additional costs including freight, travel, and reasonable living expenses, if such costs are incurred by Coleman Hanna. During the remainder of the one (1) year warranty period Coleman Hanna is responsible for the repair or replacement of warranted equipment or part. Purchaser is responsible for freight costs and labor, if incurred. Any and all equipment and/or parts returned to Coleman Hanna shall be accompanied by a **Returned Goods Authorization (RGA)** and must include serial number of unit in which equipment and/or parts was removed.

Components or equipment sold by Coleman Hanna but manufactured by others shall carry that manufacturers warranty, which shall not be less than Coleman Hanna limited warranty.

The Coleman Hanna shall not be responsible for repairs, replacements, or adjustments to equipment or any costs of labor performed by purchaser or others without Coleman Hanna prior written approval. This warranty does not apply to components or parts which have been misused, altered, neglected, not installed, adjusted, maintained, or used in accordance with applicable codes and ordinances and in accordance with Coleman Hanna recommendations as to such factors. Coleman Hanna does not warrant loss of income, should there be any, during such time repairs, replacements or adjustments are being made.

This warranty does not apply to damage resulting from improper operation or abuse, exceeding the rated capacities of the unit, improper installation or maintenance, operational neglect, neglect of manufacturers recommended maintenance, customer strike damage, nuisance calls, or acts of God.

This warranty is in lieu of all warranties, express or implied, of either Coleman Hanna or seller. Coleman Hanna makes no warranty against infringement of the like, makes no warranty of merchantability, makes no warranty of fitness for a particular purpose, and makes no other warranty, express or implied, including implied warranty arising from course of detailing or usage of trade.

Compliance with any local governmental laws or regulations relating to the location, use or operation of the equipment, its use in conjunction with other equipment, shall be the responsibility of the purchaser. The rights and obligations of the parties shall be governed by the state of Texas.

TABLE OF CONTENTS

1. EQUIPMENT PLANNING AND ARRANGEMENT	6
1.1 Unpacking The Equipment.....	6
1.2 Using Suggested Installation Procedures.....	6
2. SAFETY INSTRUCTIONS.....	7
2.1 Important Safety Instructions	7
3. INSTALLATION GUIDELINES	8
3.1 Pre-Installation Planning	8
OPTIVA Position Diagram	9
3.1.2 Pulling the Electrical Cables.....	9
3.2 General Installation	10
3.2.1 Mounting	10
3.2.2 Electrical Hookup	16
Electrical Wire Schematic.....	17
Grounding The Equipment	19
LOW VOLTAGE control and communication hookup	20
3.3	
3.5	
3.6	
3.7 Printer Installation (Axiohm)	22
3.7.1 Installing The Paper	23
4.1	
8. OPTIVA TECHNICAL DIAGRAMS	

1. EQUIPMENT PLANNING AND ARRANGEMENT

1.1 Unpacking The Equipment

Before any operation can be carried out there must be a time of planning. This is no different for the installation of the **OPTIVA**. Carefully plan the **OPTIVA** layout and setup before starting the installation process.

Thoroughly inspect each component for visible damage. Uncrate the equipment only if there is no damage.

 **NOTE:** Carefully inspect and evaluate the freight upon arrival. If there is damage to any boxes or crates immediately report it to the freight carrier.

1.2 Using Suggested Installation Procedures

This manual contains a suggested installation procedure. Located in the back are electrical schematic and layout drawings. They should be used in assistance of equipment hook-up.

Completely read through this manual **prior** to beginning installation. This will ensure a proper understanding of the system and its installation procedures.



The installation of this equipment involves high and low voltage electrical connections. Only qualified and trained personnel should be used in it's hook-up.



This equipment's circuit protection is located in the main electrical panel of the building supplying power to this device. Insure that this protection is in place and rated according to the guidelines set forth on the equipment not to exceed 15 amps.

2. SAFETY INSTRUCTIONS

2.1 Important Safety Instructions

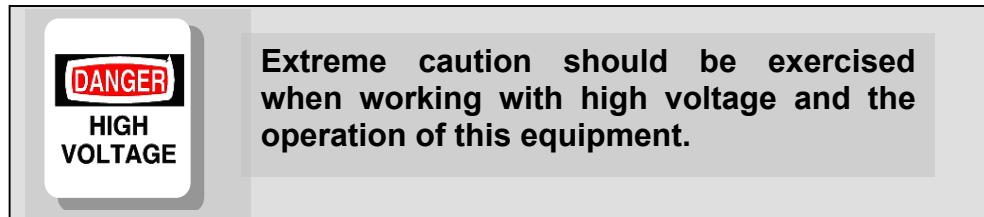

Do not throw away these important safety instructions. The instructions pertain to risk of fire, electrical shock, and or injury to persons.

- Read all instructions before using this product.
- STAY ALERT- Always give complete attention to your actions.
- Do not operate this product when fatigued or under the influence of alcohol or drugs.
- Keep operation area clear of all persons.
- Do not attempt to reach over equipment or stand on any unstable support. Keep good footing and balance at all times.
- Disconnect all power before installing or servicing this equipment. If the power disconnects are out of sight, lock it in the open position and tag it to prevent unexpected application of power. Failure to do so could result in fatal electrical shock.
- A qualified electrician should install all wiring according to local, state, and federal electrical codes.

3. INSTALLATION GUIDELINES

3.1 Pre-Installation Planning

- Locate the 2 drawings in the back of this manual (OPTIVA Conduits Drawing and OPTIVA Position Drawing)

Insure that the contractor has this information for proper layout and positioning of the OPTIVA and the underground electrical conduits.

3.1.1 Diagrams

- Optiva Conduits Drawing

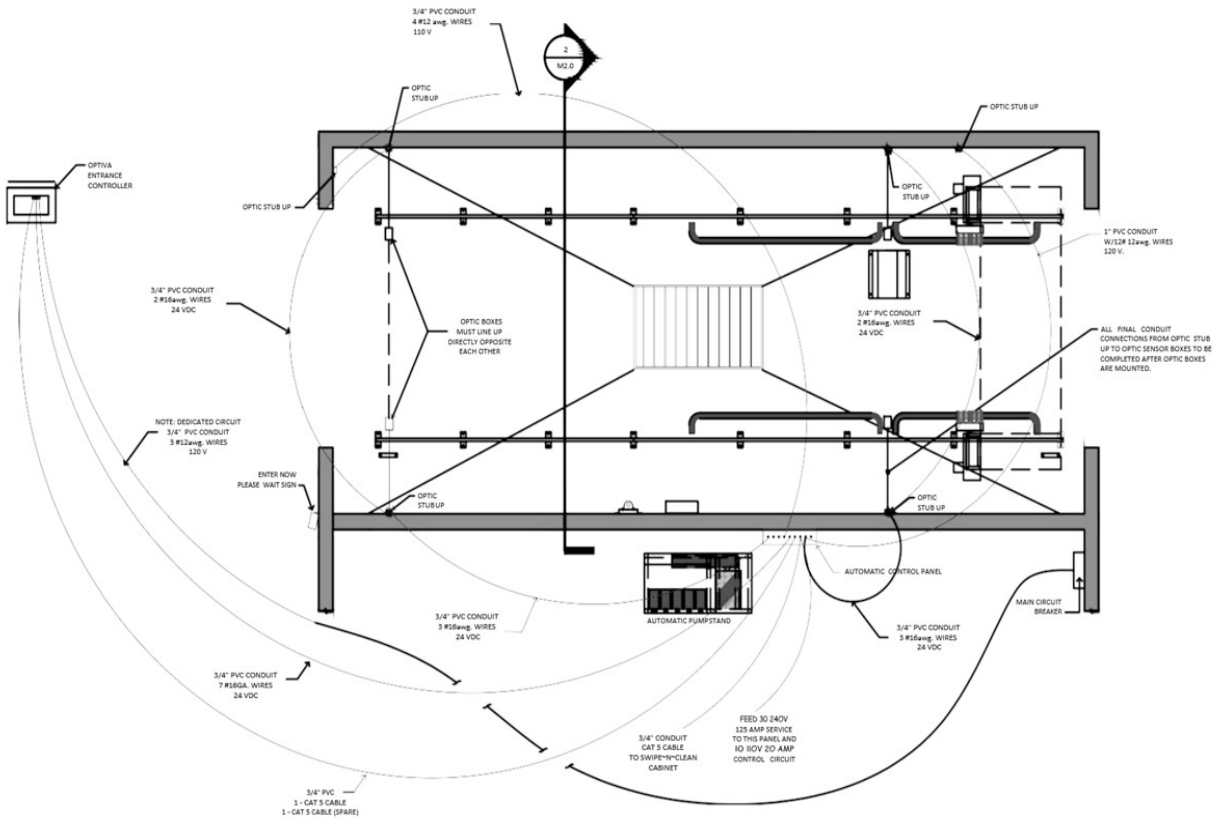

□ **OPTIVA Position Diagram**

Position the center of the Optiva 15' from the exterior wall of the carwash building.

Position the front edge of the Optiva 4' 4 - 7/8" from the center line of the bay.

3.1.1 Diagrams

□ **Optiva Conduits Drawing**

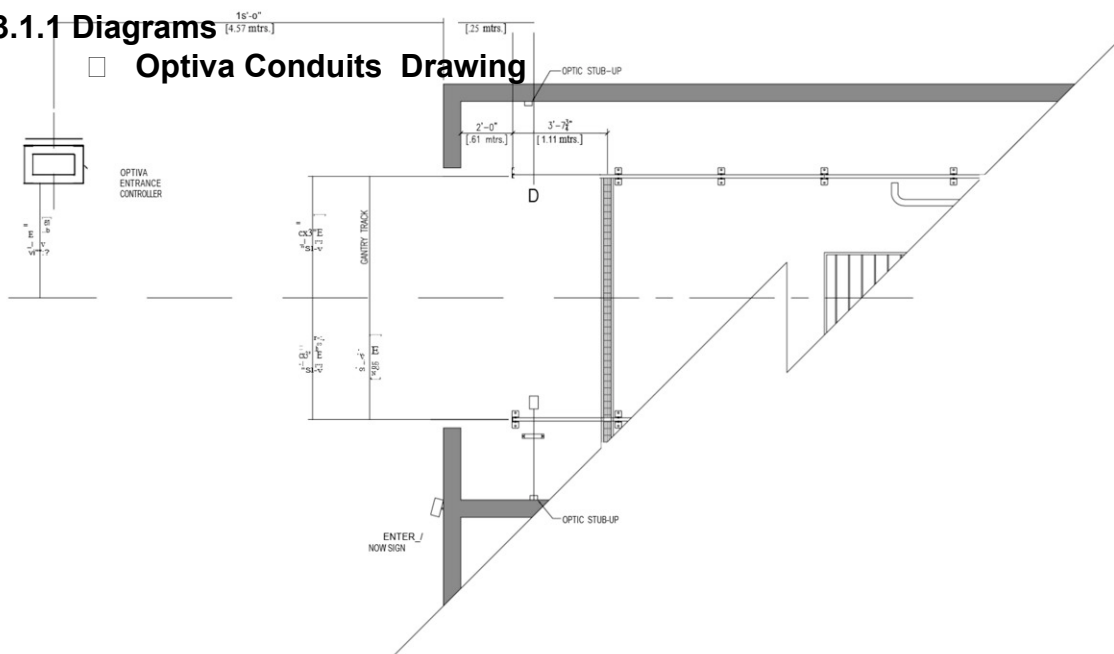

3.1.2 Electrical

- Two conduits will be installed for the electrical.

3.1.2 Pulling the Electrical Cables

- 1 – 3/4" conduit for 120VAC power and control cable
 - Pull in three 12 Ga. wires for the 120VAC.
- 1 – 3/4" conduit for communication, CAT 5 cable and/or POS 4000
 - Pull in one 1 CAT 5 Cable. shielded communication cable for connection to Site controller
 - Pull in one 7 conductor 22 Ga. control cable for Water Wizard control.
 - Pull in one 1-Spare Cat 5 cable.

3.2 General Installation

NOTE: Please use the following outlined order for proper installation.

3.2.1 Mounting

- The Optiva is comprised of 2 main components:



□ Figure 3.2.A



Figure 3.2.B

- The Base (**Figure 3.2.A**) and the Cabinet (**Figure 3.2.B**).
- Mount the base to the concrete over the electrical stub ups using ½” concrete bolts. (**Figure 3.2.C**)



Figure 3.2.C

- After locating the exact position of the base, put base in place and mark the mounting holes. Remove the base and drill each hole to accommodate the mounting bolt that will be used, insuring that all drilling dust is cleaned away from the drilled hole.
- Re-position the base over the drilled holes with “F” marking the front (**Figure 3.2.D**) and hammer in the mounting bolts ensuring that they fit into the holes. Allow room for the threads to be used for final tightening. Tighten down the nuts on the mounting bolts securing the base. The Base must be level. You might need to shim the base to make it level.

DANGER
HIGH
VOLTAGE

The installation of this equipment involves high and low voltage. Only qualified electrical personnel should be used in it's hook-up.

- Have a qualified electrician to terminate the 2 – ¾” conduits to the base by extending the electrical stub ups with Liquitite or other waterproof Flexible electrical conduit.
- Pull the electrical cables as previously indicated in section 3.1.2 observing the separation as indicated. (⚠ **Note: Do not include any communication cables in the high voltage conduit.**) Be sure and pull at least 36” of cable past the termination point on the base. (Figure 3.2.E)

⚠ **NOTE: Termination point is referenced to top of base.**

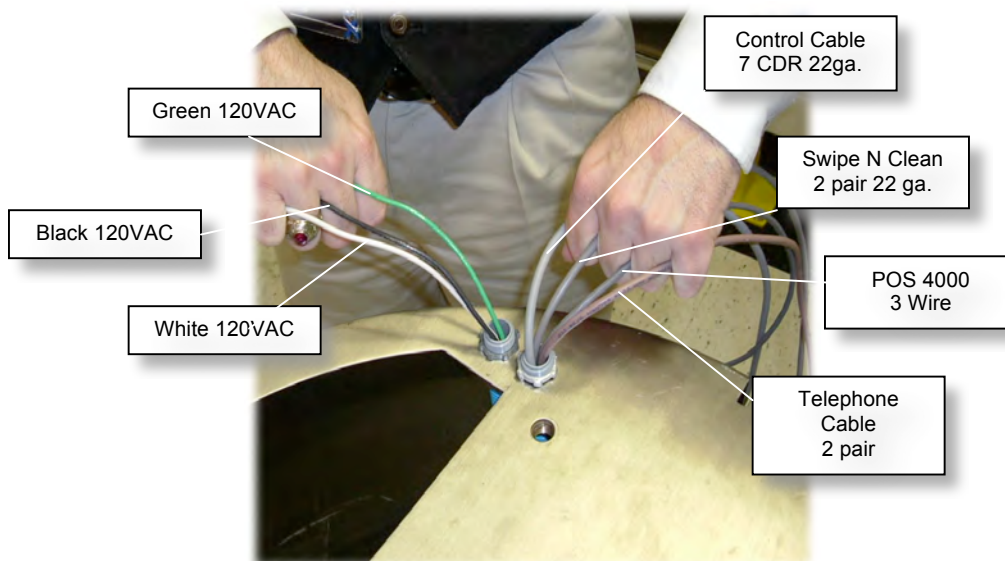

Figure 3.2.E

✓ **This completes mounting the base.**

- Open the door on the Optiva cabinet. Remove all packing material, manuals, mouse, and keyboard.
- Remove the coin hopper by slightly sliding forward (Figure 3.2.F) and lifting up (Figure 3.2.G).



Figure 3.2.F

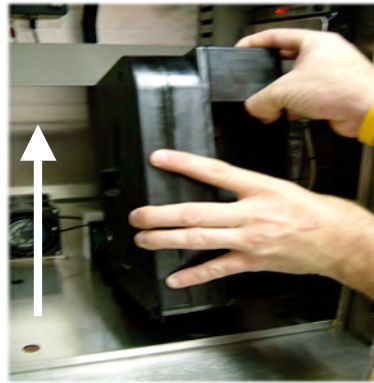

Figure 3.2.G

- Remove the 2- 1/4" nuts to remove the back cover of the incoming electrical box.



- Remove the Stainless Steel plate to access the 4 holes to mount the Optiva to the Base using a 5/16" nut driver. The photo below shows the Stainless Steel plate with the hopper attached.

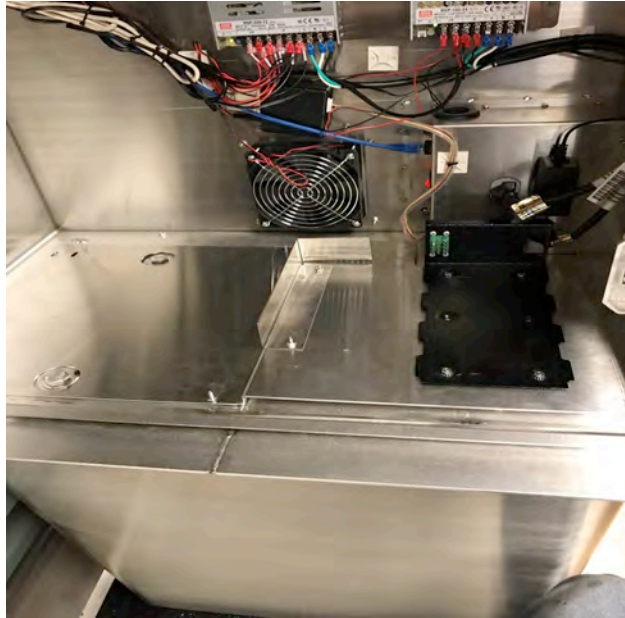

Photo below show the Stainless steel plate removed to access the 4- 1/2" Bolt holes.



The installation of this equipment involves heavy lifting. Take extreme care when lifting and placing the equipment. Insure adequate help is available and use proper lifting techniques.

- With the assistance of at least one person, carefully lift the Optiva cabinet up to base height. Guide the previously pulled electrical cables up through the electrical opening in the bottom of the cabinet. Carefully lower cabinet to base.

 **NOTE: Be careful to not pinch the cables between the cabinet and base.**

- The base and the cabinet will self align when positioned in place. Locate the four bolts used for mounting the cabinet to the base. Put some type of lubricant on the bolts, such as **AntiSeize**, to prevent the bolts from galling up on the stainless. Locate the four holes in the cabinet for the insertion of the bolts. Snug the bolts down tightly. **(Figure 3.2.K)**



Locations of the four boltholes.

Figure 3.2.K

Electrical Hookup

DANGER

**HIGH
VOLTAGE**

The installation of this equipment involves high and low voltage. Only qualified electrical personnel should be used in it's hook-up.

After opening the electrical covers in the cabinet, extend the wires that have been previously pulled into the electrical trough through the holes in the electrical panel and out the side of the cabinet (**Figure 3.2.N**).

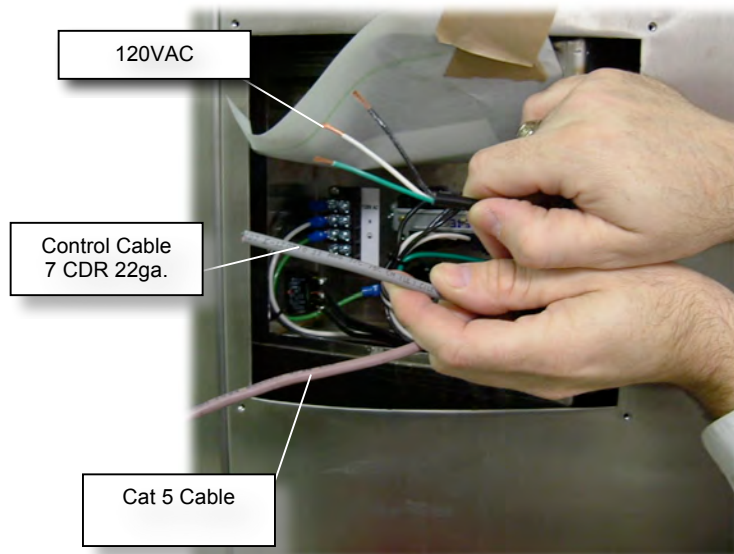
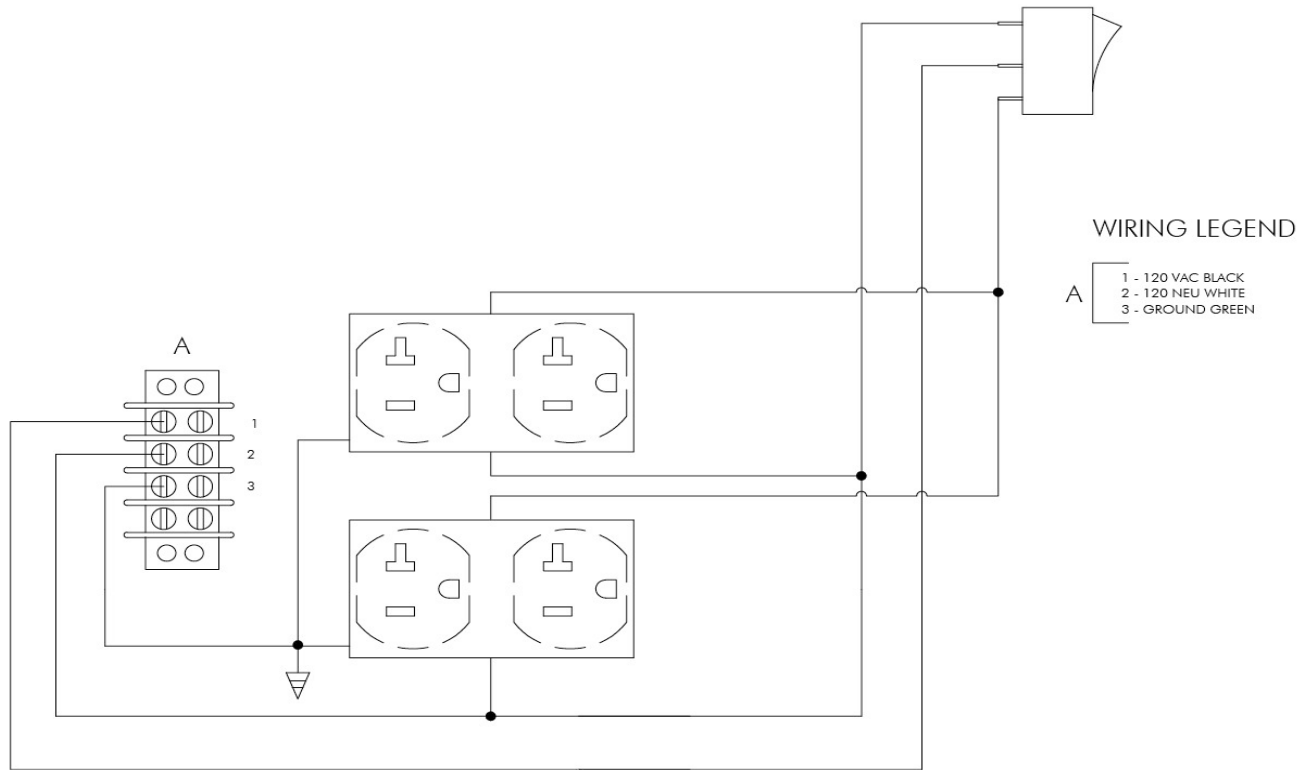

Figure 3.2.N

- Connect the electrical wires to the cabinet using the Electrical Wire Schematic as a guideline (**Figure 3.2.O**).

Electrical Wire Schematic



This unit requires a dedicated 120-volt circuit. Pull Three 12 gauge wires into Optiva electrical box. The wires should be color coded as follows: Black 120 volt hot, White 120 volt neutral and Green (ground). (**Figure 3.2.P**)

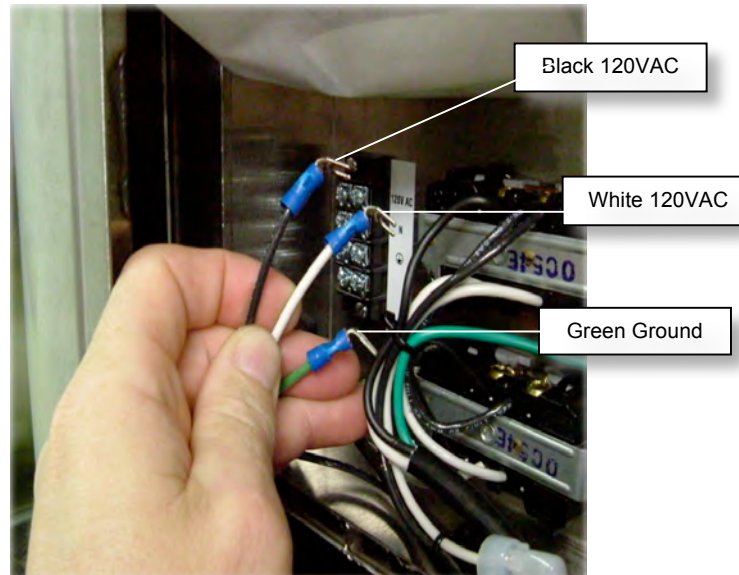

Figure 3.2.P

- Connect the electrical wires to the Three position terminal strip located on the left hand side of the electrical box. Connect the Black wire to terminal one (top position), Connect the White wire to terminal two and connect the Green wire to terminal three. Also, see the Electrical Schematic attached to this Installation instructions. (**Figure 3.2.Q**)

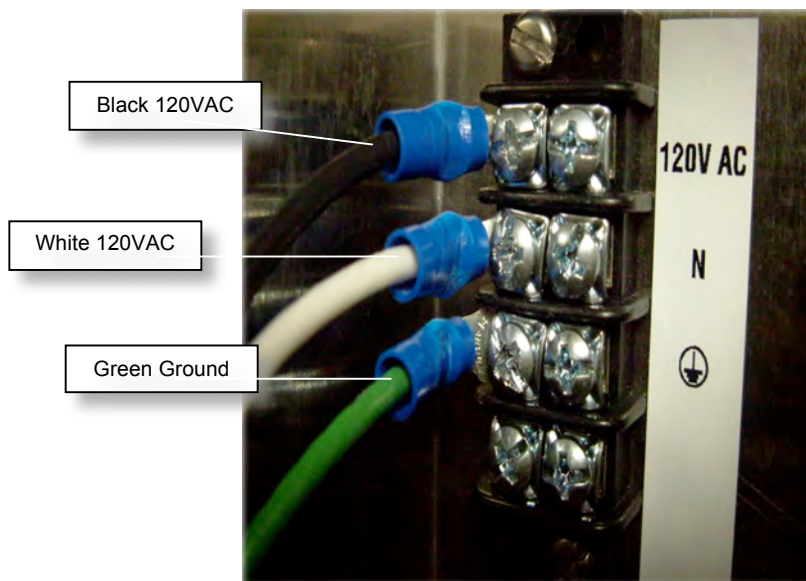

Figure 3.2.Q

- **Grounding The Equipment (follow the instructions below)**
 - A 12-gauge equipment-grounding conductor green in color must be run with the circuit conductors and connected to the *equipment-grounding terminal*. **(Figure 3.2.W)**

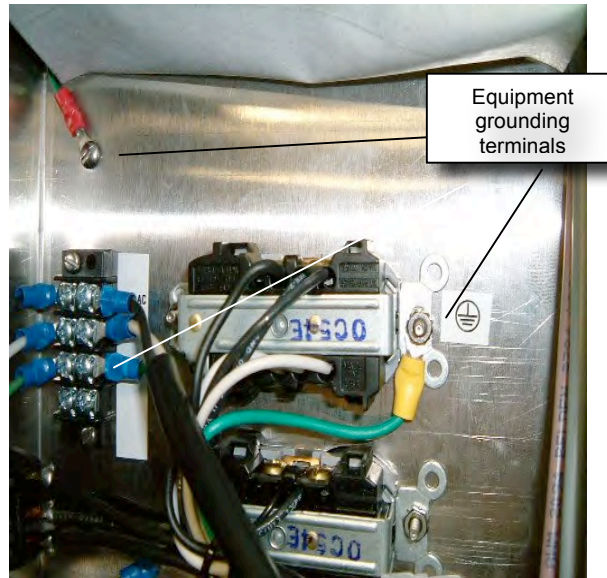

Figure 3.2.W

- Use copper conductors only.
- The *equipment-grounding terminal* is located inside the electrical terminal box on the backside of the Optiva. **(See Figure 3.2.W)**
- A qualified electrician must complete this connection. This equipment is intended for general public use only. It is not to be used in potentially dangerous locations such as flammable, explosive/chemically-laden areas.

The following section will guide you through the LOW VOLTAGE control and communication hookup. The Cat 5 Cable will connect to the plug inside the electrical box in the upper right hand corner. The other low voltage cables run thru the grommet in the top of the box and then to the terminal strips mounted on the back of the cabinet.

Connect Cat 5
cable here



- Pull in communications cables to inside cabinet and run to the terminal strip shown below. You must run at least a 7 conductor cable between the Water Wizard Electrical Control panels to the Optiva. See copies of the electrical schematics at the back of this manual.

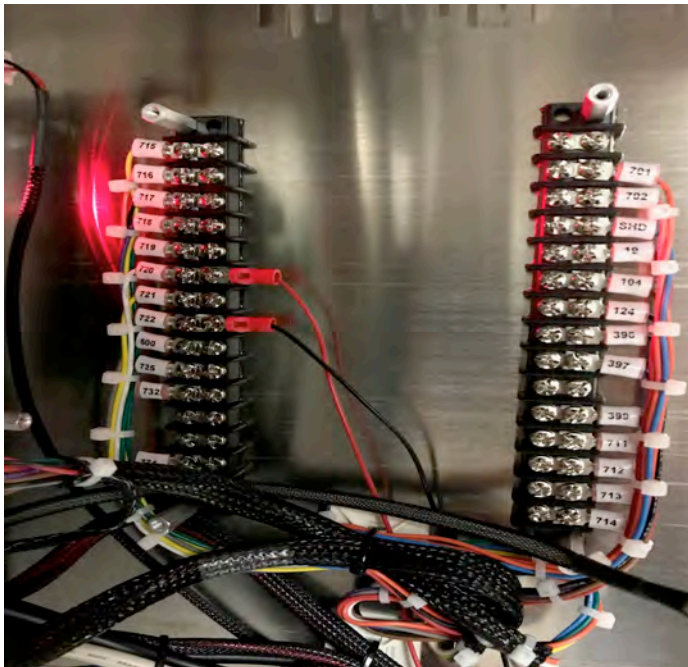

- Replace the Stainless Steel base inside the Optiva and then the coin hopper by placing it on the bottom (**Figure 3.2.Y**) and sliding backward until it stops and locks in place. (**Figure 3.2.Z**)



Figure 3.2.Y



Figure 3.2.Z

🔗 **NOTE:** At this point put coins to be dispensed into the Coin Hopper (shown in Figures 3.2.Y and 3.2.Z above). Approximately \$250.00 in quarters should be placed into the Coin Hopper for maximum storage.

3.7 Printer Installation (Figure 3.7.A)

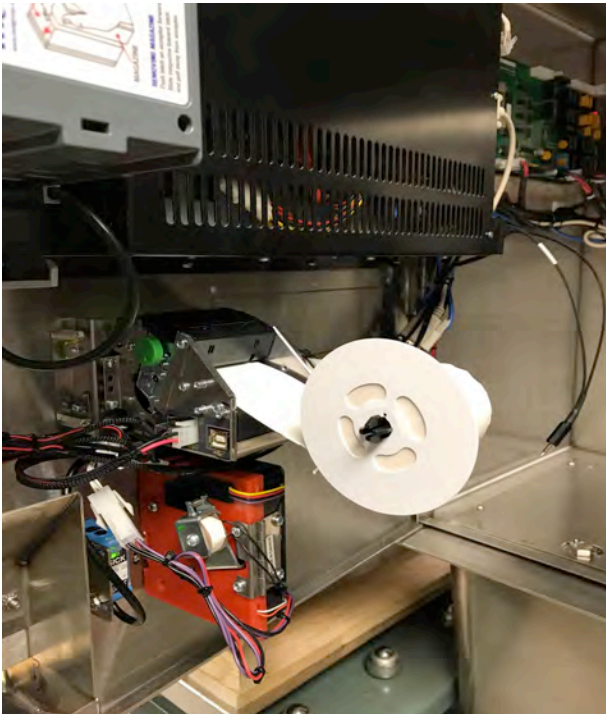

(Figure 3.7.A)

3.7.1 Installing the Paper

Installing the paper for the Printer is an easy process.

- Feed the paper into the head of the printer making sure the paper comes off the bottom of the roll and enters into the printer. Once fed properly the printer will pull the paper forward and cut it off. If the paper is feed into the printer upside down the printer will not print.

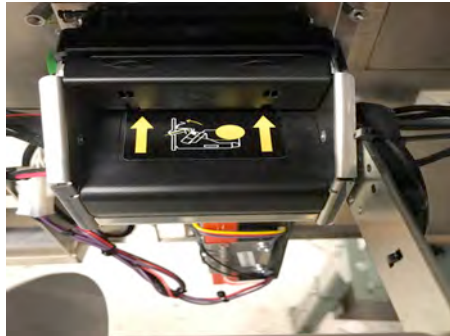
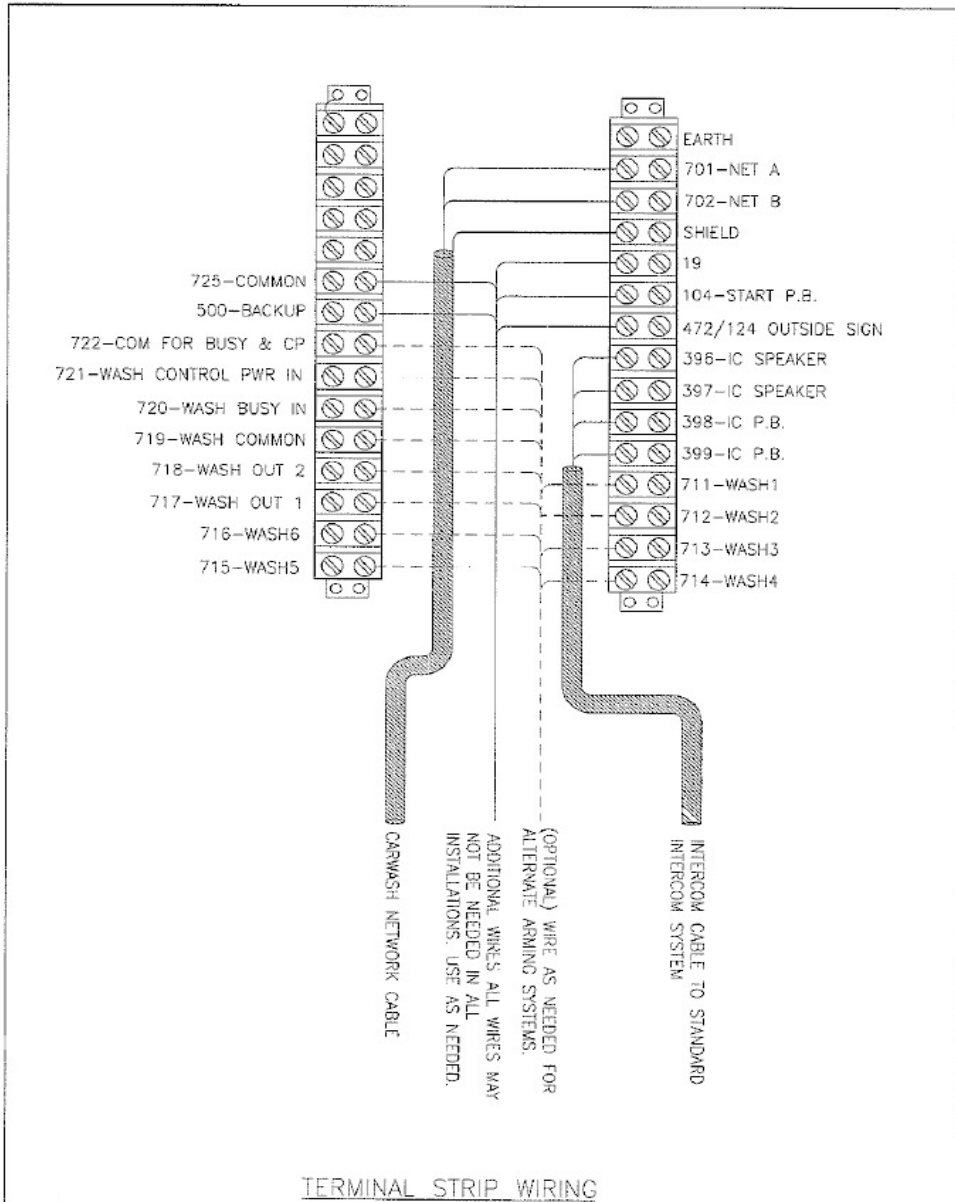

Figure 3.7.C

✓ **THIS COMPLETES THE OPTIVA INSTALLATION AND CONNECTION.**

⚠ **NOTE:** It is important for you, the merchant, to acknowledge that Coleman Hanna Car wash Systems LLC is not responsible for any charges occurring from credit card processors. It is your responsibility, as the merchant, to negotiate, manage, and handle any customer complaints, credit card fees, or general problems surrounding your credit card processing and merchant account. No calls will be accepted by the technical staff at Coleman Hanna regarding these issues.

Terminal Strip Diagram



SHEET 4 OF 4

INFELIO TECHNOLOGIES, INC. 10590 ASTOR STREET, IRVINE, CA 92606		All specifications subject to change without notice		PRODUCT					
INSTALLATION/ ACTIVA COINBOX		SCALE	DATE	ACTIVA					
		NONE	6/7/07	COINBOX					
REV	DWG NO.	DESIGN	CHK'D	B	N/A	REVISED FOR 2 CONDUITS REQUIRED	REV	8/20/07	REB
C	AC-1-0003	REB	6/7/07	A	N/A	REVISED VARIOUS NAMING CONVENTIONS	REV	8/15/07	REB
				LTN	EGD	DESCRIPTION	BY	DATE	APP'D

FORM #19477-03B REV B 1/21/97

712-wash 4
713-wash-3
714-wash 2
715-wash 1

When manual arm....711 not used
712,713,714,715 wash cycles
On PPC wash 2,3,4,5

719-cycle common -

721-out of service + from Auto

720-wash in use + from Auto(On a water Wizard output#14)
722-wash in use - from Auto

722 is the common for 721 & 720

Program the Water Wizard redlion to show you are using a Unitec entrance controller so that it will have a wash in use signal coming out of the ROC16 output#14 will be on when the Water Wizard is washing a vehicle.

Panel PC

