



**eFusion**  
**PARTS**  
**MANUAL**



# ***CONTENTS*** .....



## ***TABLE OF***

### ***eFuson Parts Manual***

Gantry Side Brush Carriage - Passenger Side.....	2
Gantry Side Brush Carriage - Driver Side.....	4
Side Brush Carriage - End View.....	6
Gantry Top Brush - Drive Assembly.....	8
Gantry Lower - Inside - Passenger.....	10
Gantry - Driver's Side - Lower (Left Side).....	12
Gantry - Wheel Brush Assembly - Passenger Side (Right Side).....	14
Gantry - Wheel Brush Assembly - Driver's Side (Left Side).....	16
Gantry - Drive and Count Wheels.....	18
Gantry - Oscillating Blower Assembly.....	20
Gantry - Instruction Signs.....	22
Gantry Drive - Passenger Side - (Right Side).....	24
Gantry Drive-Driver's Side.....	26
Gantry Upper - Top Brush Drive.....	28
Gantry Upper - Top Brush.....	30
Low Pressure Box.....	32
High Pressure Box.....	34
Gantry Electrical Panel- Lower.....	36
Low Pressure Pumps.....	38
Pump Stand - Front End View.....	40
Pump Stand - CAT Pump.....	42
Pump Stand - Lower Front.....	44
Pump Stand - Rear.....	46
Control Panel - Pump Stand.....	48
Gantry Control Panel - Upper.....	50



# Gantry Side Brush Carriage Passenger Side

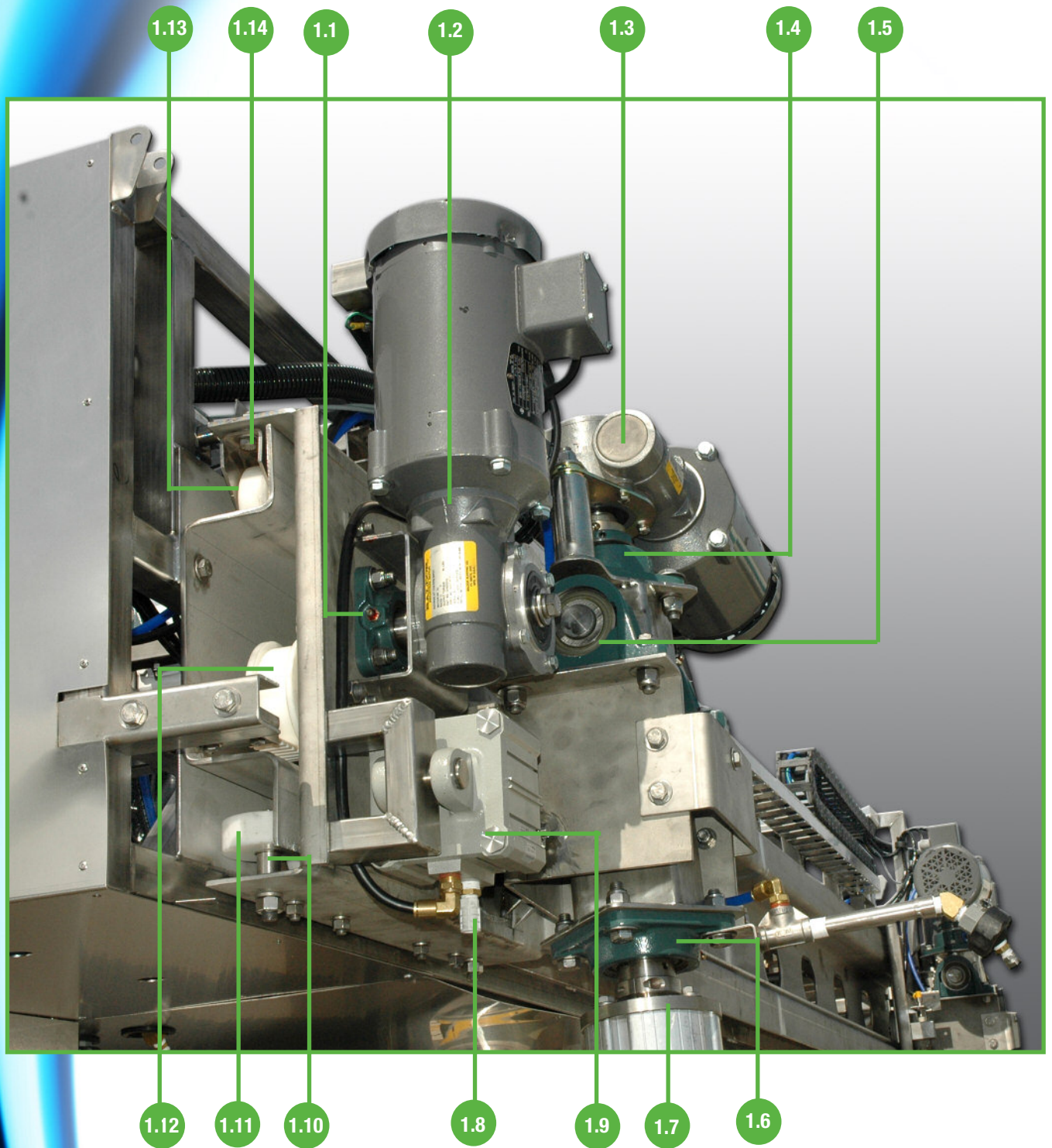

**Gantry Side Brush Carriage - Passenger Side**

ITEM #	PART #	DESCRIPTION
1.1	07511	Bearing, Flange 1" 4 Bolt
1.2	55001	Gear Motor, 10:1 Washdown HS
1.3	55001	Gear Motor, 10:1 Washdown HS
1.4	07514	Bearing, Flange Roller 1-1/2"
1.5	06851	Pillow Block Bearing 1-1/4" -VPS-120
1.6	07531	Bearing, Flange 1-1/2" 4 Bolt
1.7	07574	Side Brush Shaft & Flange (MS-AC11 & MS-AC12)
1.8	07502	Muffler, Pneumatic
1.9	07501	Air Cyl, 100mm Bore X 25 mm
1.10	07827	Side Brush Carriage Roller Bolt Horizontal Roller (MS-AC26)
1.11	07825	Side Brush Carriage Roller (MS-AC51)
1.12	07828	Belt Idler Pulley (MS-AC52)
1.13	07825	Side Brush Carriage Roller (MS-AC51)
1.14	07826	Side Brush Carriage Roller Vertical Bracket (AC004-1)



# Gantry Side Brush Carriage Driver Side

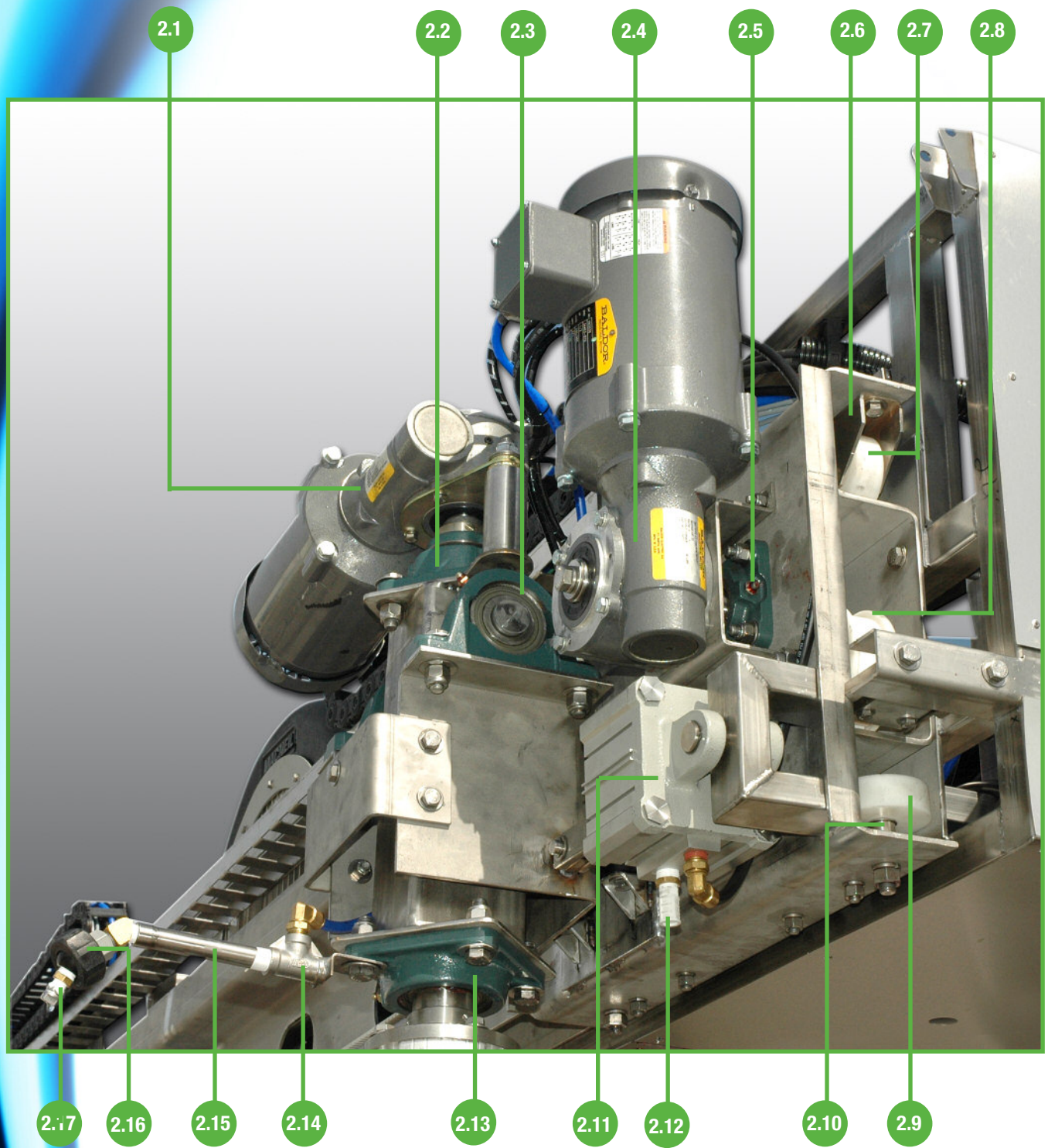

**Gantry Side Brush Carriage - Driver Side**

ITEM #	PART #	DESCRIPTION
2.1	55001	Gear Motor, 10-1 Washdown HS
2.2	07514	Bearing, Flange Roller 1-1/2"
2.3	06851	Pillow Block Bearing 1-1/4" -VPS-120
2.4	55001	Gear Motor, 10-1 Washdown HS
2.5	07511	Bearing, Flange 1" - 4 bolt
2.6	07826	Side Brush Carriage Roller Vertical Bracket (AC004-1)
2.7	07825	Side Brush Carriage Roller (MS-AC51)
2.8	07828	Belt Idler Pulley (MS-AC52)
2.9	07825	Side Brush Carriage Roller (MS-AC51)
2.10	07827	Side Brush Carriage Roller Bolt - Horizontal Roller (MS-AC26)
2.11	07501	Air Cyl, 100mm bore X 25mm
2.12	07502	Muffler, Pneumatic
2.13	07513	Bearing, Flange 1-1/2" 4 Bolt
2.14	07230	Mitter Lube Pipe T Bracket - Stainless Steel (MC018-1 & 22441)
2.15	07829	Mittler Lube Pipe 6" Stainless Steel
2.16	06561 and 06562	Nozzle Adjustable Ball Fitting & Threaded Ball - Plastic
2.17	84104	Mitter Lube Spray Tip # 2507



**Side Brush Carriage  
End View**

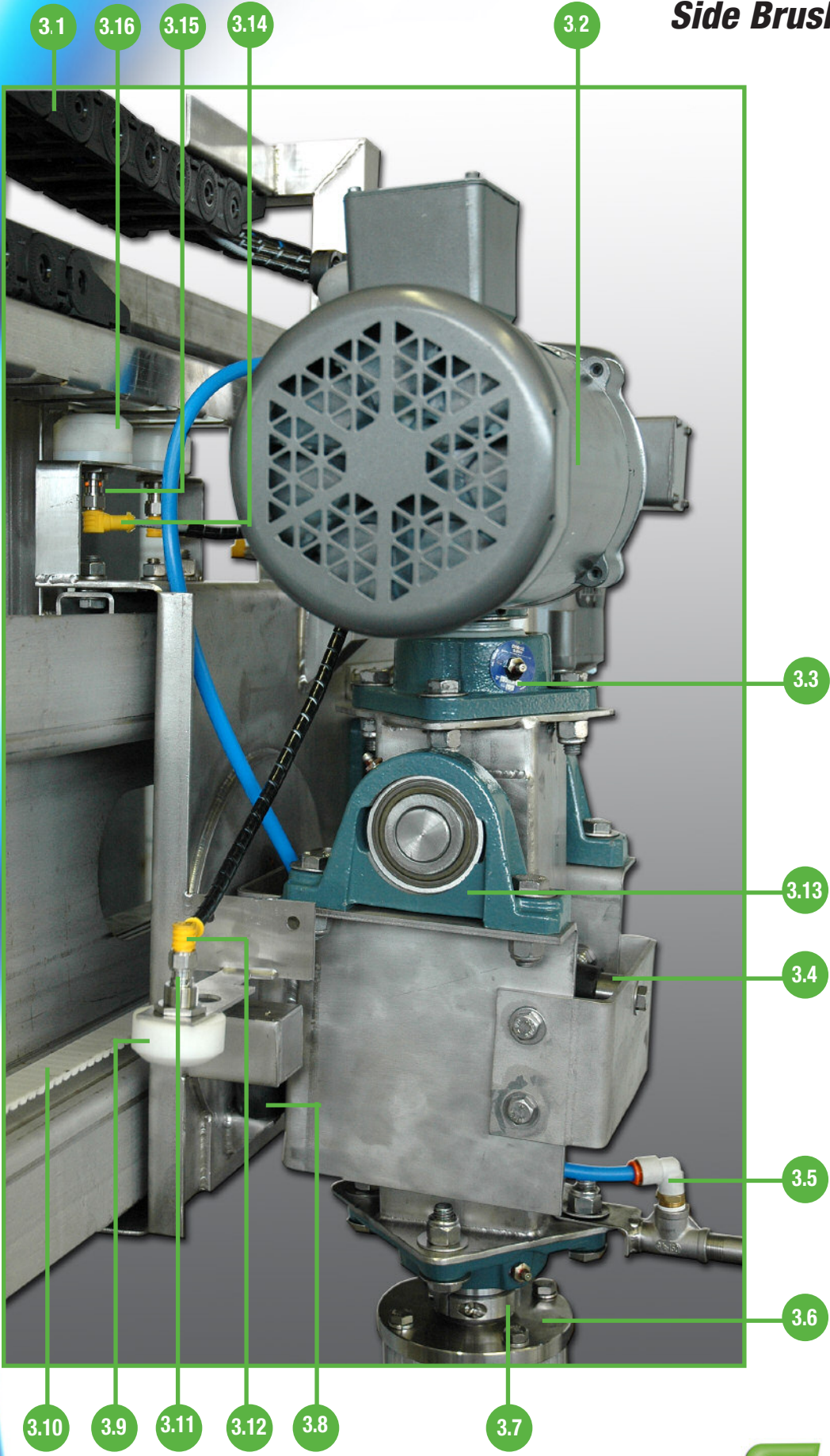

3.1

3.16

3.15

3.14

3.2

3.3

3.13

3.4

3.5

3.6

3.10

3.9

3.11

3.12

3.8

3.7

6

**Side Brush Carriage - End View**

ITEM #	PART #	DESCRIPTION
3.1	07515-1	Cable Carrier - 34 Links
3.2	55001	Gear Motor, 10-1 Washdown HS
3.3	07514	Bearing, Flange Roller 1.5"
3.4	07528	Rubber Stopper
3.5	22-W169-PL-6-6	90 Degree Push Lock Fitting
3.6	07574	Side Brush Shaft & Flange (MS-AC11 & MS-AC12)
3.7	07510	Lock Collar 1-1/2"
3.8	07528	Rubber Stopper
3.9	07821	Prox Protector
3.10	06852	Belt - Kevlar Side Brush Carriage ( 15' )
3.11	06626	Prox 18mm
3.12	06650-12	Cable Prox 90 Degree
3.13	06851	Pillow Block Bearing 1-1/4" - VPS -120
3.14	06650-12	Cable Prox 90 Degree
3.15	06626	Prox 18mm
3.16	07821	Prox Protector
3.16	07821-1	Prox Protector Spacer



# Gantry Top Brush Drive Assembly

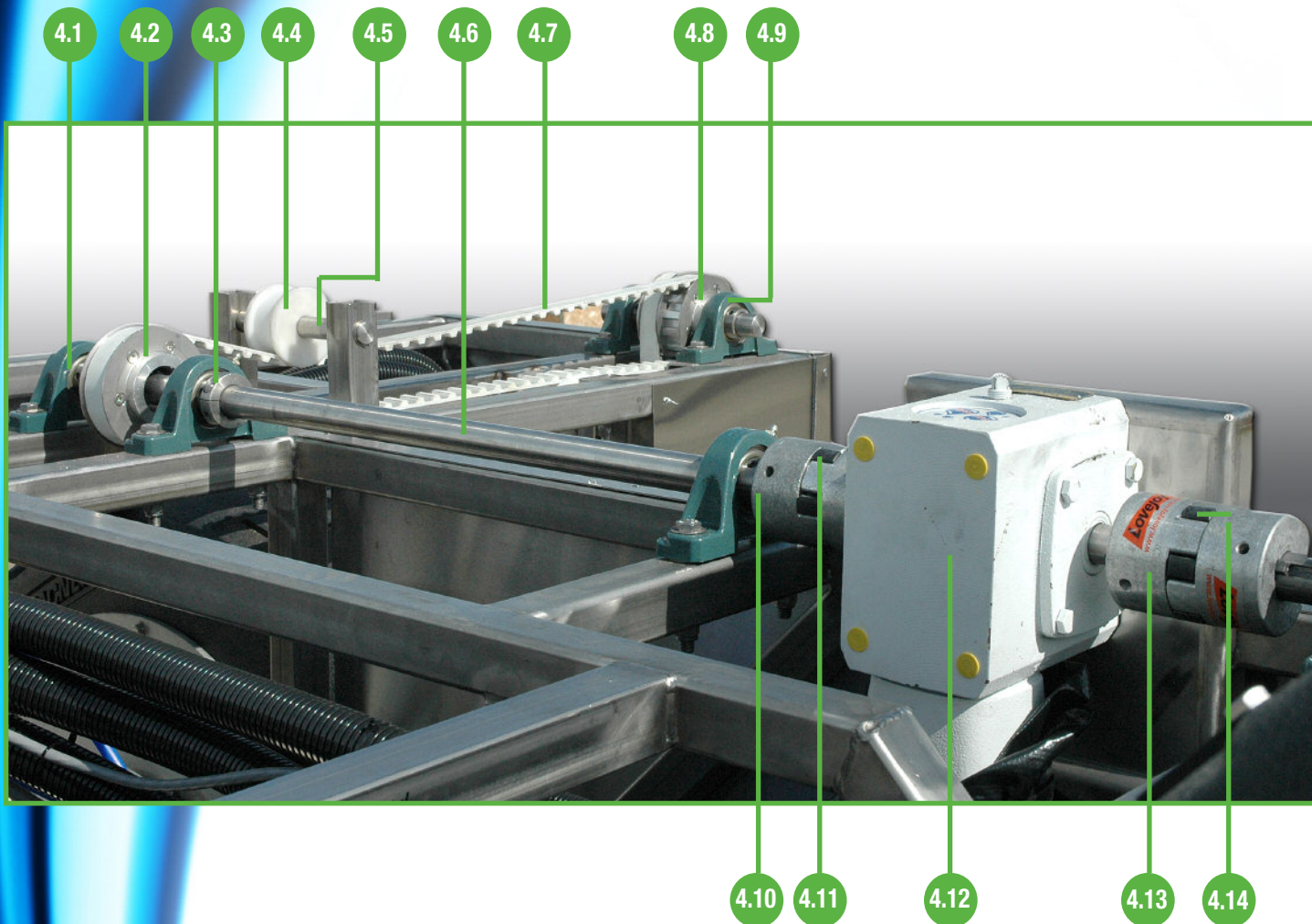

**Gantry Top Brush - Drive Assembly**

ITEM #	PART #	DESCRIPTION
4.1	06850	Pillow Block Bearing 1" - VPS - 116
4.2	18009	Pulley Cog T20 -25mm (Single) - Aluminum
4.3	06830	Lock Collar 1"
4.4	07822	Idler Pulley (MS-AC52)
4.5	07823	Idler Pulley Shaft (MS-AC64)
4.6	07824	Top Brush Drive Shaft - 1" X 31" (MS-107)
4.7	18013	Boom Belt - Continuous Loop
4.8	18010	Pulley Cog T20 - 50mm (Double) - Aluminum
4.9	06850	Pillow Block Bearing 1" - VPS - 116
4.10	06800	Love Joy 1" Drive Shaft
4.11	06803	Love Joy Spider
4.12	55227-1	Gear Box, DBBL Shaft 50:1
4.13	06801	Love Joy 7/8" Gear Box
4.14	06803	Love Joy Spider



# Gantry Lower - Inside Passenger

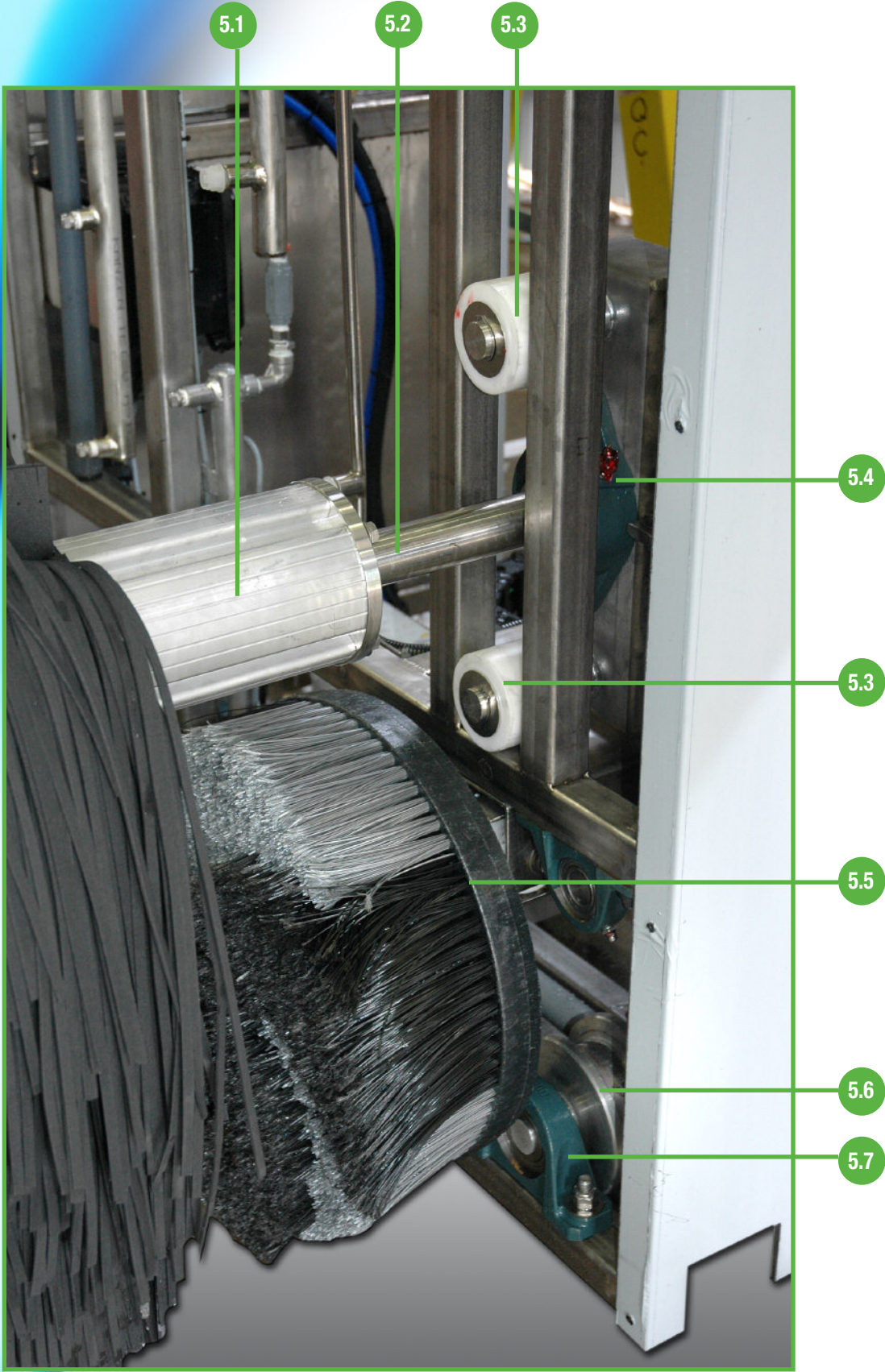

**Gantry Lower - Inside - Passenger**

ITEM #	PART #	DESCRIPTION
5.1	07571	Brush Core - Top Brush Fusion
5.2	07573	Top Brush Shaft & Flange Passenger Side (MS-AC17&MS-AC12)
5.3	07816	Top Brush Rollers (MC-AC55)
5.4	07512	Bearing Flange 1-1/2" - 2 Hole
5.5	07519	Wheel Brush
5.6	06500-W	Drive Wheel
5.7	06851	Pillow Block Bearing 1-1/4" - VPS - 120



**Gantry - Driver's Side  
Lower (Left Side)**

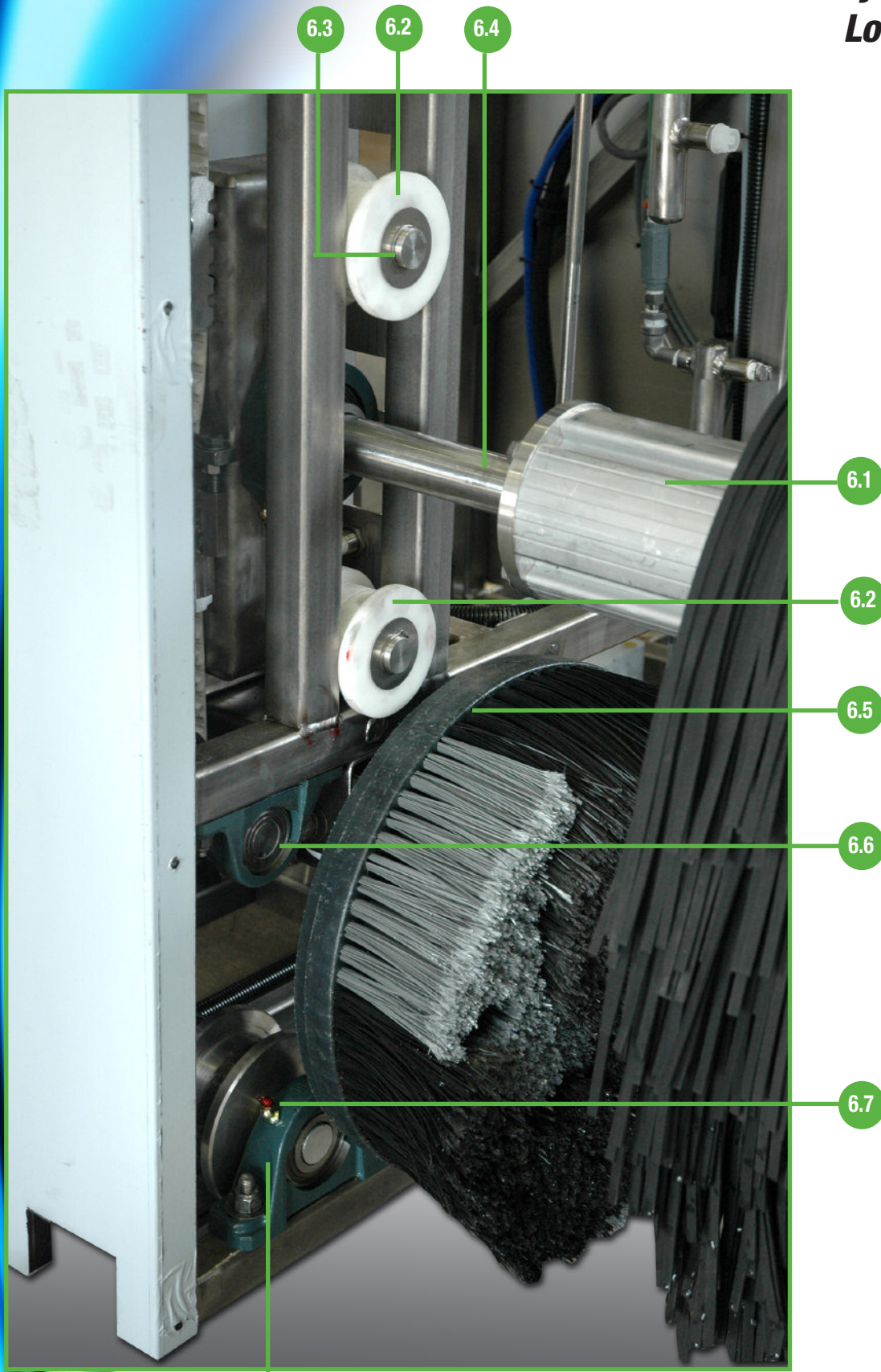

**Gantry - Driver's Side - Lower (Left Side)**

ITEM #	PART #	DESCRIPTION
6.1	07571	Brush Core - Top Brush Fusion
6.2	07820	Guide Rollers Halves (MS-AC56)
6.3	49097	Snap Ring 1"
6.4	07572	Top Brush Shaft & Flange - Drivers Side (MS -AC16&MS-AC12)
6.5	07519	Wheel Brush
6.6	06850	Pillow Block Bearing 1" - VPS - 116
6.7	06500-W	Drive Wheel
6.8	06851	Pillow Block Bearing 1-1/4" - VPS - 120



## Gantry - Wheel Brush Assembly Passenger Side (Right Side)

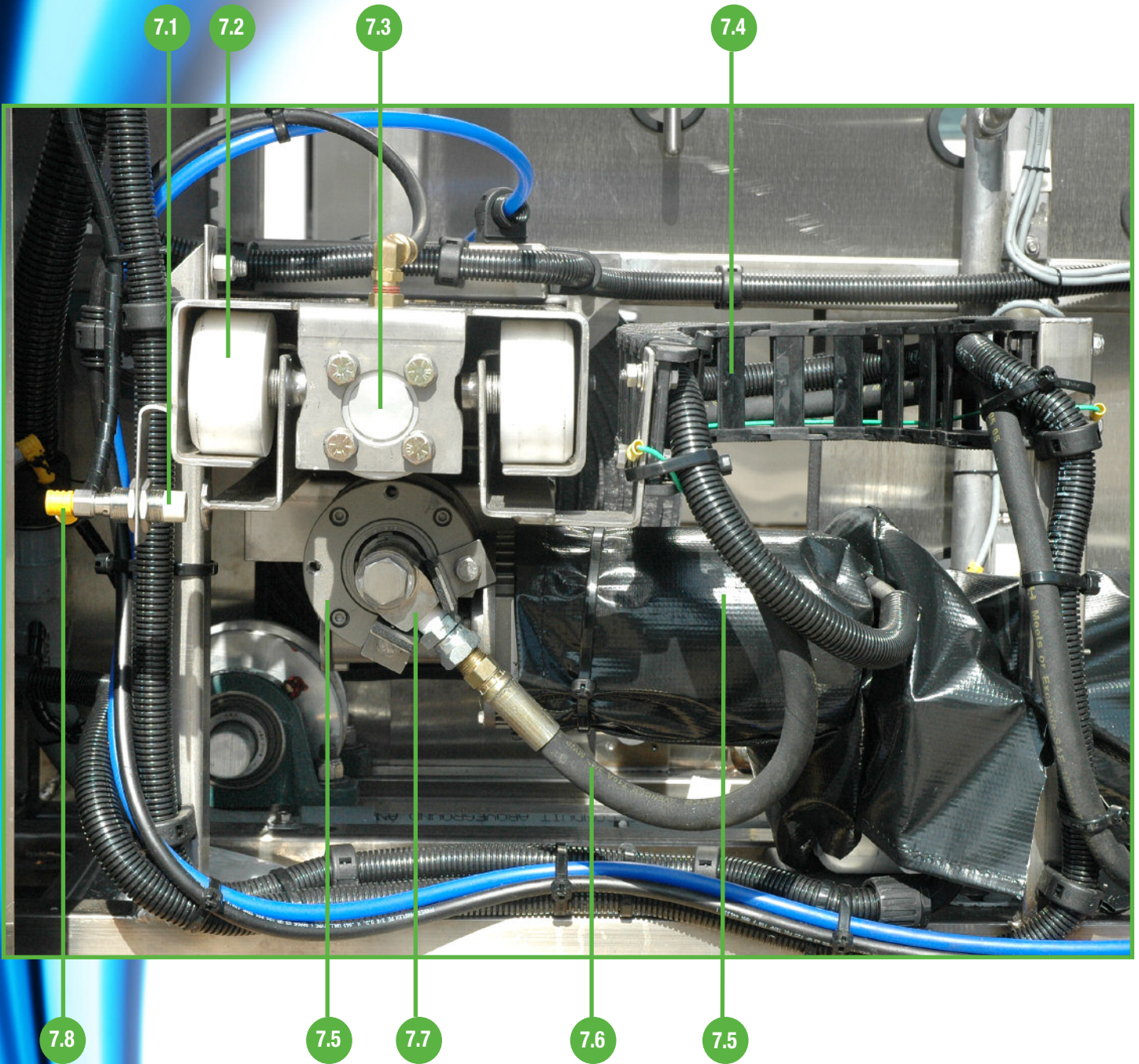

**Gantry - Wheel Brush Assembly - Passenger Side (Right Side)**

ITEM #	PART #	DESCRIPTION
7.1	06626	Prox - 18mm
7.2	07815	Slide Rollers
7.3	07504	Air Cyl, 2.5" X 18"
7.4	07515-2	Wheel Brush Cable Carrier
7.5	55000	Gear Motor, 1/3 Hp 30:1" Hs
7.6	52281	Wheel Brush HP Hose (3/8"x10-1/2' Wire Braid Hose W/F)
7.7	74000	Swivel 3/8ths HP M X F
7.8	06650-12	Cable, Prox 12 meter 90 Deg



## Gantry - Wheel Brush Assembly Driver's Side (Left Side)

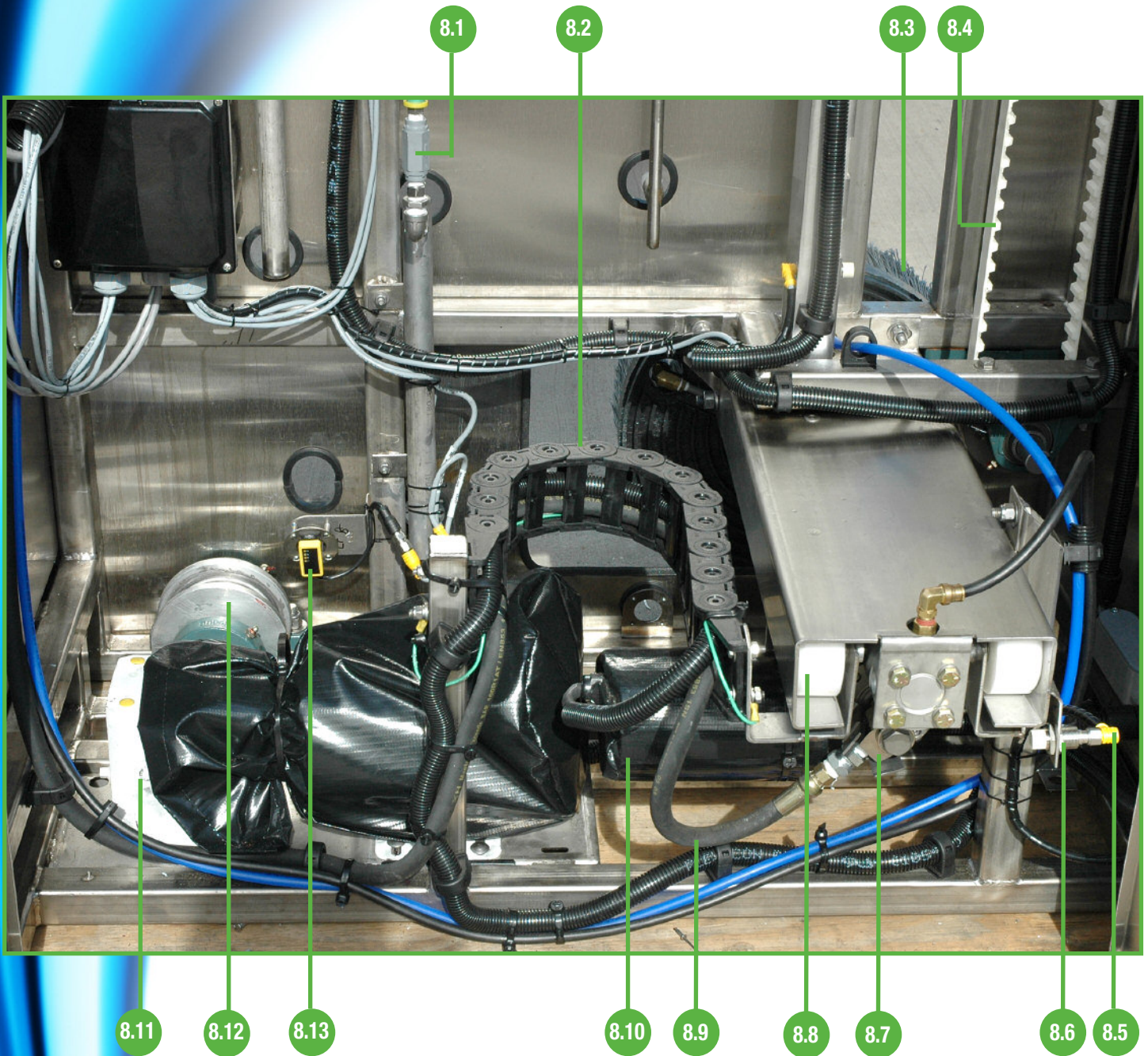

**Gantry - Wheel Brush Assembly - Driver's Side (Left Side)**

ITEM #	PART #	DESCRIPTION
8.1	34025	Check Valve - Poly 1/4"
8.2	07515-2	Wheel Brush Cable Carrier
8.3	07519	Wheel Brush
8.4	18012	Belt, Timing Kevlar 50,000 mm
8.5	06650-12	Cable, Prox 12 meter 90 Deg
8.6	06626	Prox - 18mm
8.7	74000	Swivel, 3/8" HP M X F
8.8	07815	Slide Rollers
8.9	52282	Wheel Brush HP Hose (3/8"x27-1/2' Wire Braid Hose W/F)
8.10	55000	Gear Motor, 1/3 Hp 30:1" Hs
8.11	55230-2	.5 HP 3/60 Inv. Dty Washdown Drive Motor
8.12	06500-W	Drive Wheel
8.13	06742	Emitter, 8 Channel



## Gantry - Drive and Count Wheels

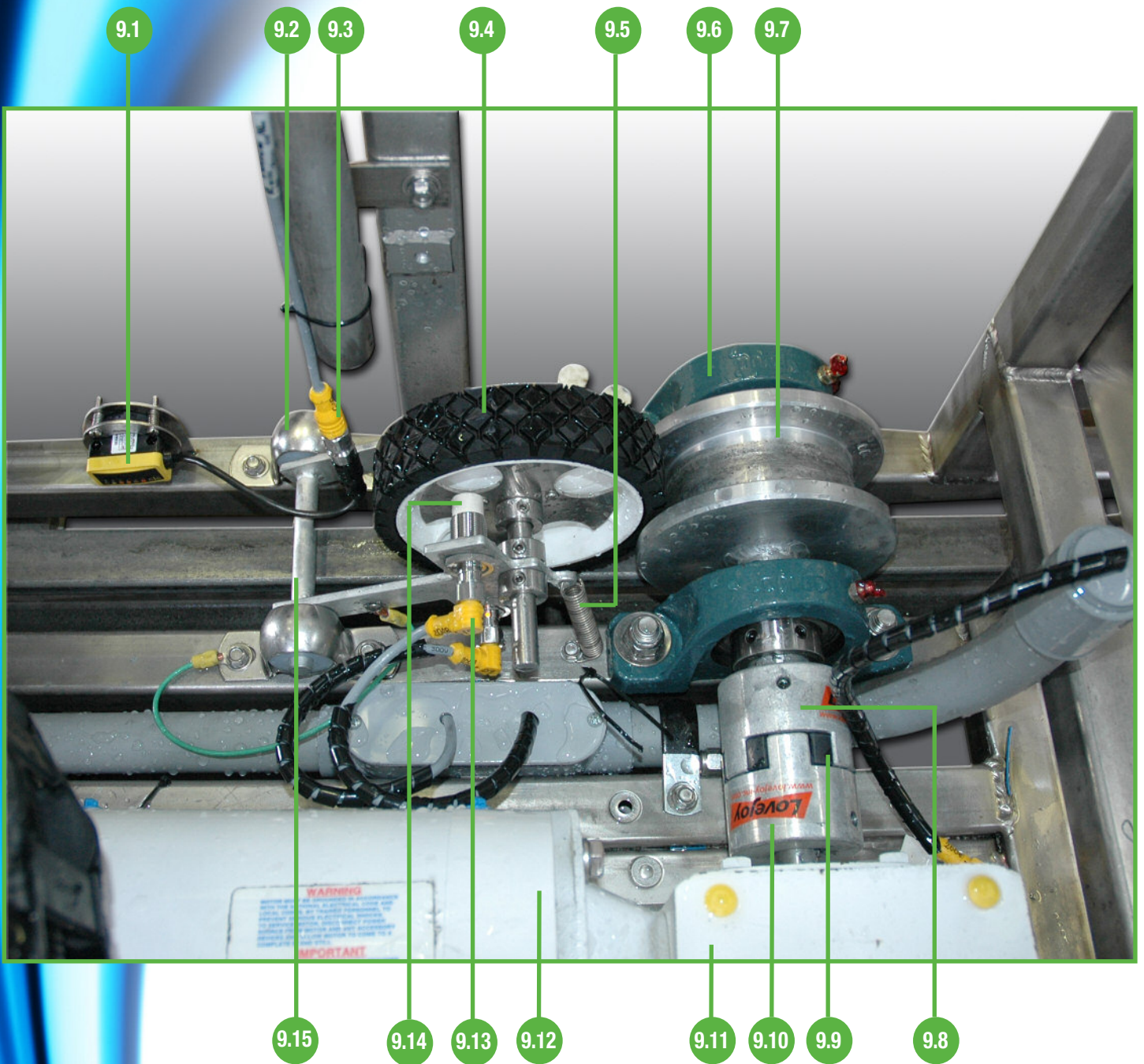

**Gantry - Drive and Count Wheels**

ITEM #	PART #	DESCRIPTION
9.1	06741	Receiver, 8 Channel
9.2	06647	Pillow Block Bearing - Nylon 1/2"
9.3	06716	Eye Cable - 2 Meter
9.4	06834	Count Wheel 1.5" x 6"
9.5	06781	Spring For Count Wheel
9.6	06851	Pillow Block Bearing - 1 1/4"
9.7	6500-W	Drive Wheel
9.8	06805	Love Joy 1 1/4" Wheel Shaft
9.9	06803	Love Joy Spider
9.10	06801	Love Joy 7/8" Gear Box
9.11	55003	Gear Box 30:1/RH - ( For Left Side Or Driver Side) Shown
9.11	55004	Gear Box 30:1/LH - ( For Right Side Or Passenger Side)
9.12	55230-2	Drive Motor - .5HP Washdown
9.13	6650-4	Cable Prox - Rt Angle 4 Meter
9.14	06626	Prox - 18mm
9.15	06835	Count Wheel Bracket



## Gantry - Oscillating Blower Assembly

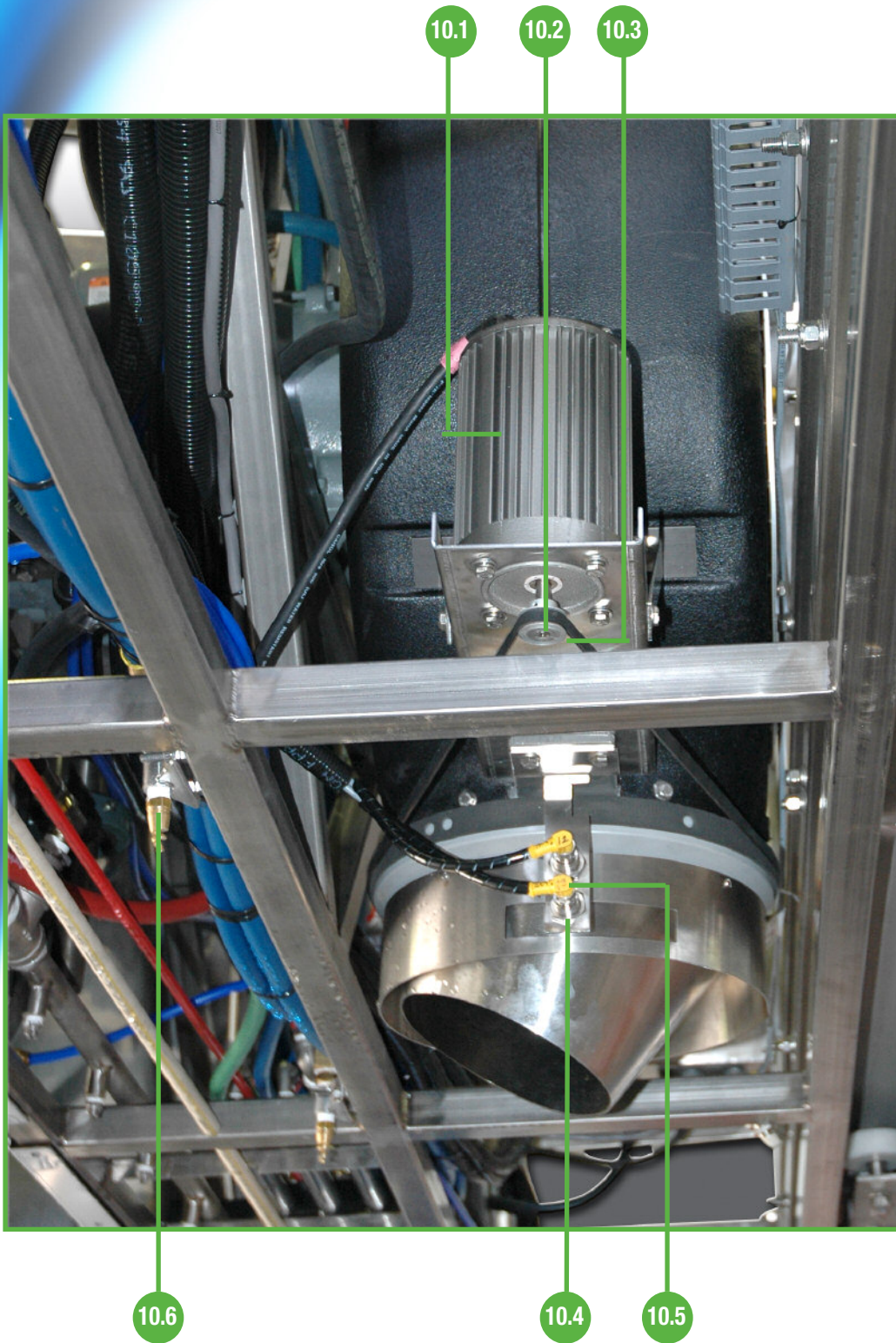

**Gantry - Oscillating Blower Assembly**

ITEM #	PART #	DESCRIPTION
10.1	55239	Motor, Oscillating - Blower
10.2	19808	Pulley For Oscillating Motor
10.3	18240-1	Belt - Smart/Oscillating Nozzle
10.4	06626	Turck Prox - 18mm
10.5	06650-6	Cable, Prox Rt Angle - 6 Meter
10.6	06589	Jet Spiral Tip - Spot Free



# Gantry - Instruction Signs



11.1

11.2

11.3

**Gantry - Instruction Signs**

ITEM #	PART #	DESCRIPTION
11.1	07550	LED Lamp 4" - Red
11.2	07552	LED Lamp 4" - Green
11.3	07551	LED Lamp 4" - Amber
11.4	06100	Scrolling Sign



# Gantry Drive - Passenger Side (Right Side)

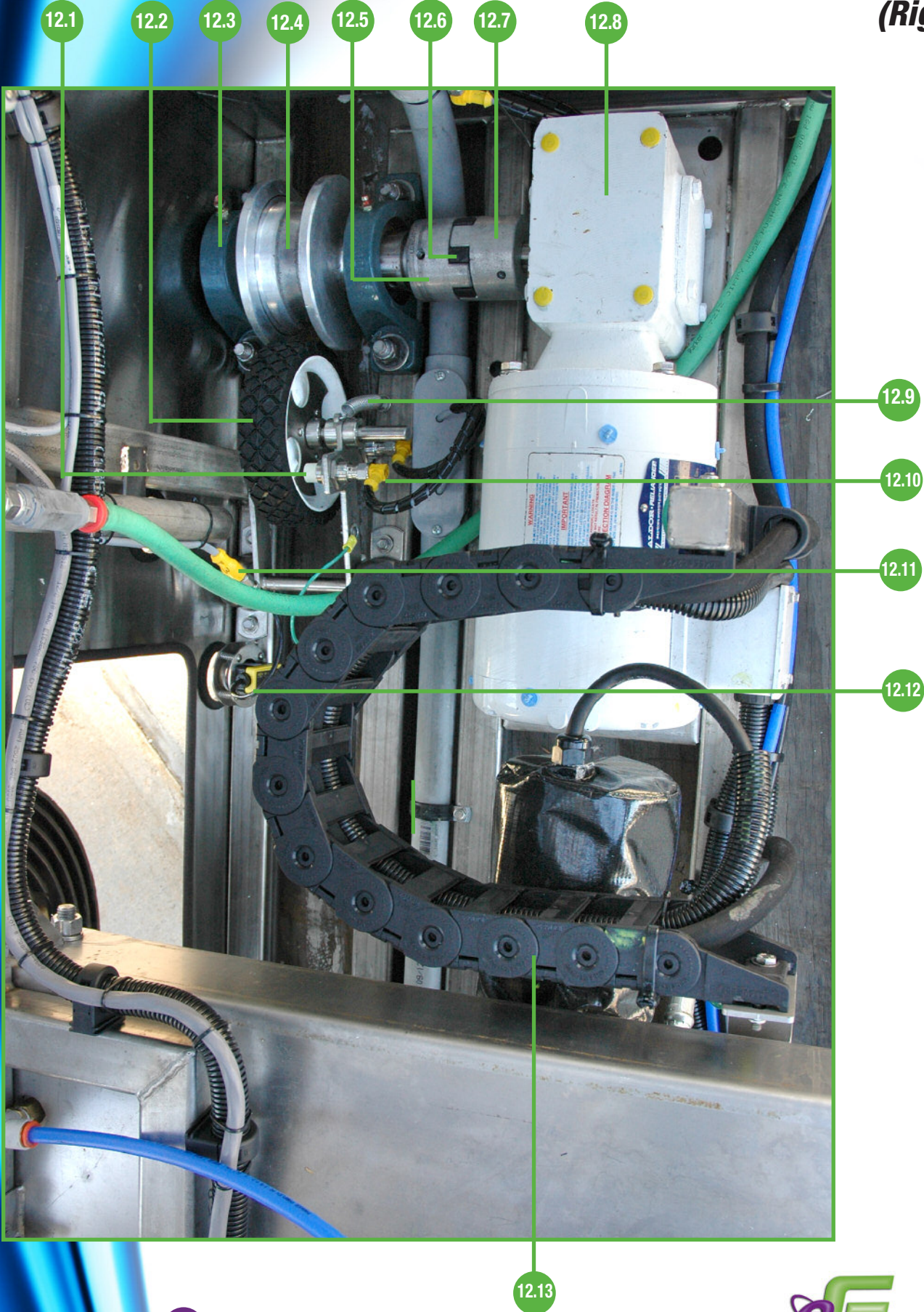

**Gantry Drive - Passenger Side - (Right Side)**

ITEM #	PART #	DESCRIPTION
12.1	06626	Prox 18mm
12.2	06834	Count Wheel 1.5" x 6"
12.3	06851	Pillow Block Bearing 1-1/4" - VPS -120
12.4	06500-W	Drive Wheel
12.5	06805	Love Joy 1 1/4" Wheel Shaft
12.6	06803	Love Joy Spider
12.7	06801	Love Joy 7/8" Gear Box
12.8	55004	Gear Box 30:1/LH (For Right Side Or Passenger Side) Shown
12.8	55003	Gear Box 30:1/RH - (For Left Side Or Driver Side)
12.9	06781	Spring For Count Wheel
12.10	06650-12	Cable Prox 90 Degree
12.11	06716	Eye Cable - 2 Meter
12.12	06741	Reciever, 8 Channel
12.13	07515-2	Wheel Brush Cable Carrier



# Gantry Drive-Driver's Side

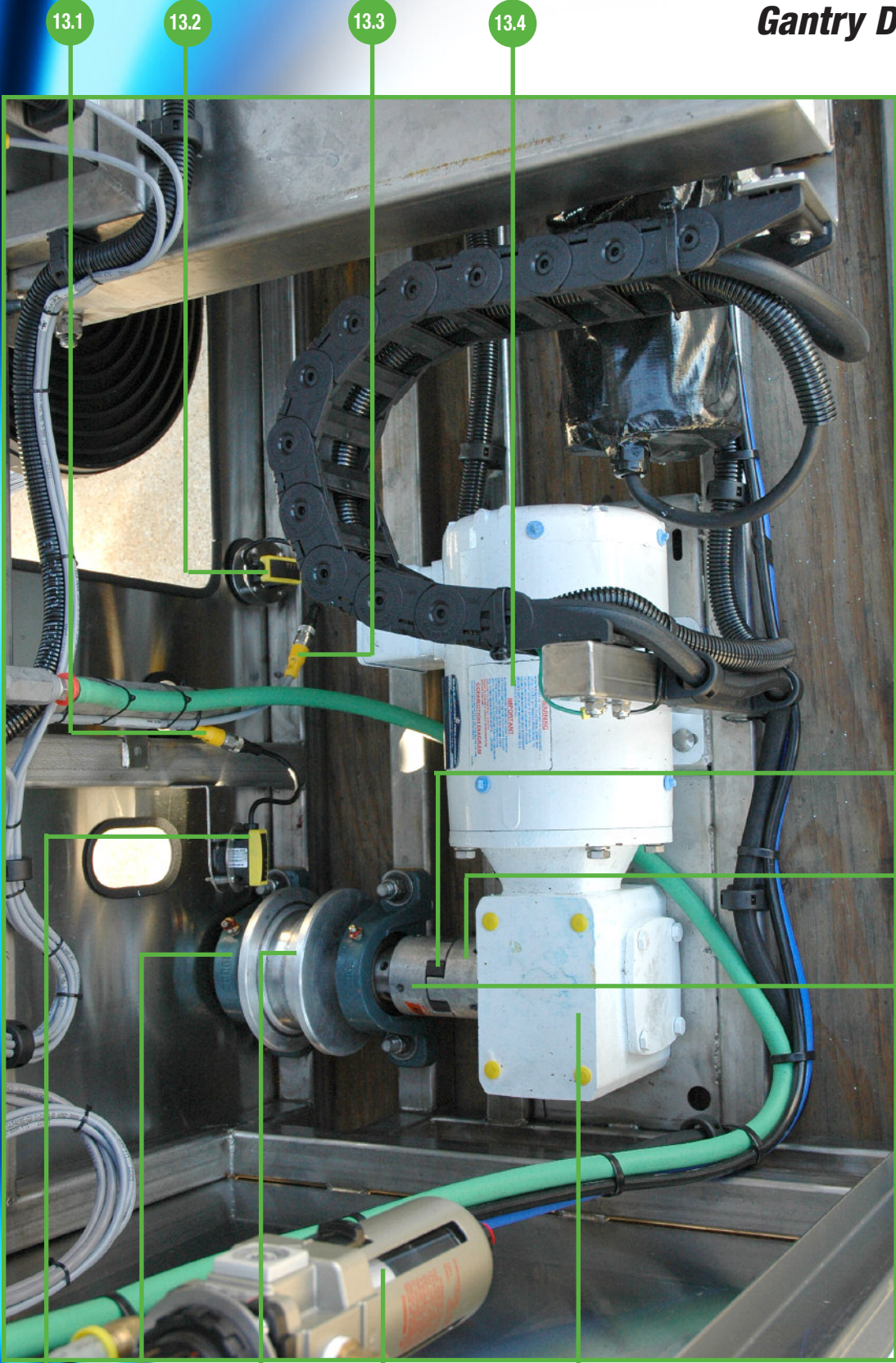

13.1

13.2

13.3

13.4

13.5

13.6

13.7

13.12

13.11

13.10

13.9

13.8

**Gantry Drive-Driver's Side**

ITEM #	PART #	DESCRIPTION
13.1	06715	Eye Cable - 4 Meter
13.2	06715	Eye Cable - 4 Meter
13.3	06742	Emitter, 8 Channel
13.4	55230-2	Drive Motor - .5HP Washdown
13.5	06805	Love Joy 1 1/4" Wheel Shaft
13.6	06803	Love Joy Spider
13.7	06801	Love Joy 7/8" Gear Box
13.8	55003	Gear Box 30:1/RH (For Left Side Or Driver Side) Shown
13.8	55004	Gear Box 30:1/LH - (For Right Side Or Passenger Side)
13.9	58090-2	Filter Regulator w/Guage & Auto Drain
13.10	06500-W	Drive Wheel
13.11	06851	Pillow Block Bearing 1-1/4" - VPS -120
13.12	06742	Emitter, 8 Channel



## Gantry Upper - Top Brush Drive

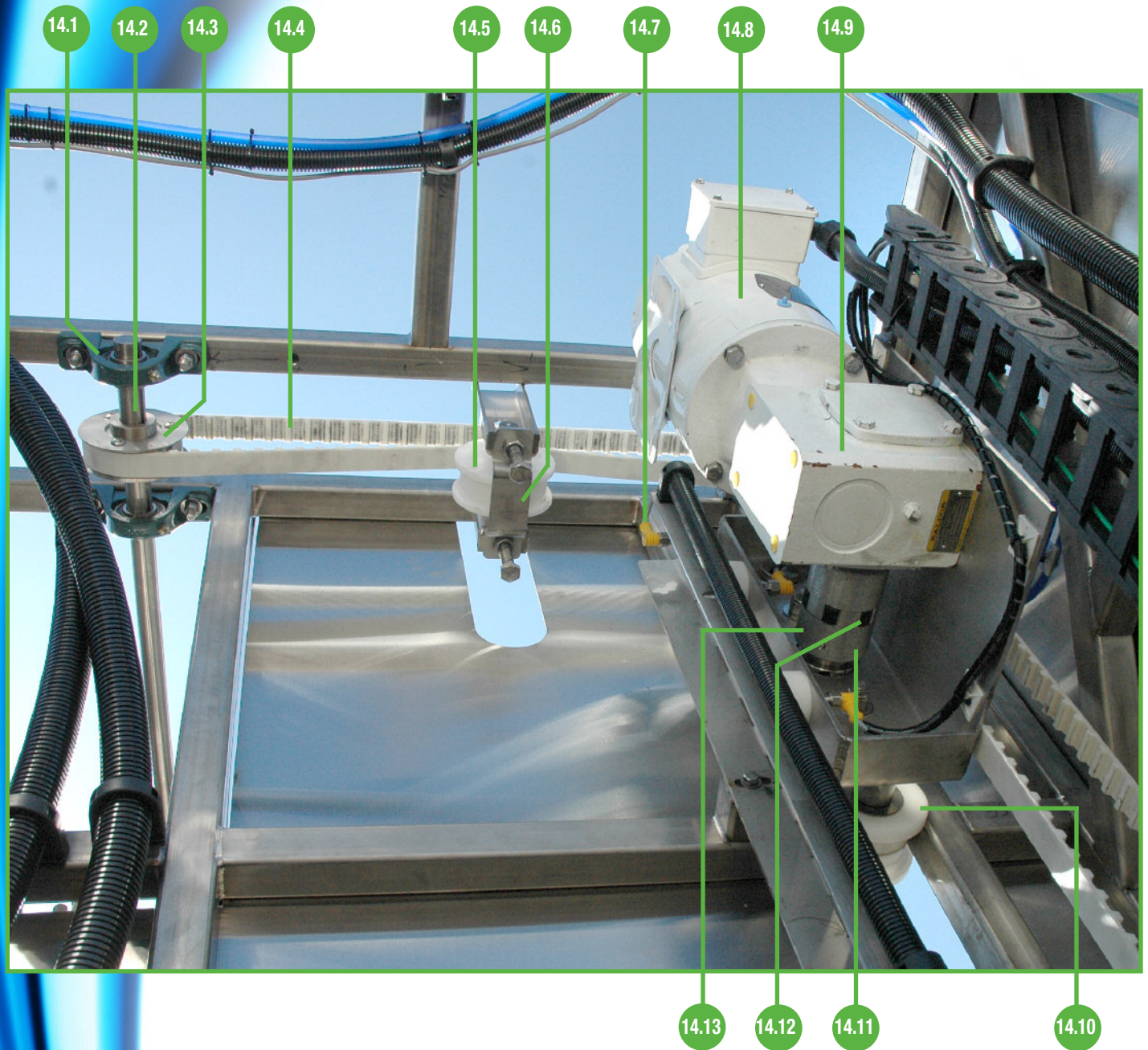

**Gantry Upper - Top Brush Drive**

ITEM #	PART #	DESCRIPTION
14.1	06850	Pillow Block Bearing 1" - VPS - 116
14.2	07824-1	Top Brush Drive Shaft - 1" X 81-1/2" (MS-144)
14.3	18009	Pulley Cog T20 -25mm (Single) - Aluminum
14.4	18013	Boom Belt - Continuous Loop
14.5	07822	Idler Pulley (MS-AC52)
14.6	07231	Belt Tension Brace Top Brush (AC034-3)
14.7	6650-4	Cable Prox - Rt Angle 4 Meter
14.8	55230-2	Drive Motor - .5HP Washdown
14.9	55002	Gear Box 10:1 RH Quill Type
14.10	07820	Guide Rollers Halves (MS-AC56)
14.11	06801	Love Joy 7/8" Gear Box
14.12	06803	Love Joy Spider
14.13	06800	Love Joy 1" Drive Shaft



## Gantry Upper - Top Brush

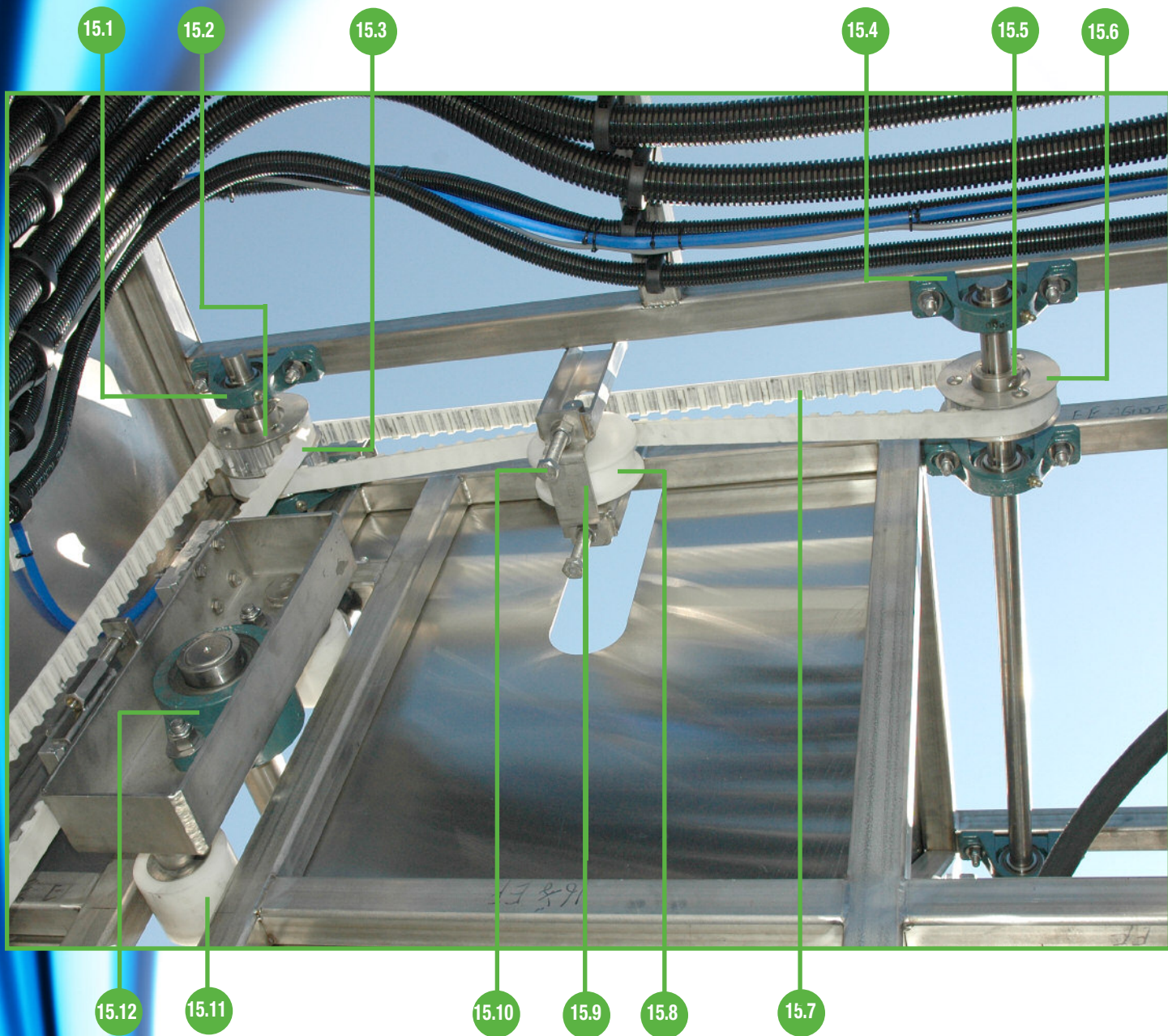

### ***Gantry Upper - Top Brush***

<b>ITEM #</b>	<b>PART #</b>	<b>DESCRIPTION</b>
15.1	06850	Pillow Block Bearing 1" - VPS - 116
15.2	18010	Pulley Cog T20 - 50mm (Double) - Aluminum
15.3	18012	Belt, Timing Kevlar 50,000 mm (T20 Belt)
15.4	06850	Pillow Block Bearing 1" - VPS - 116
15.5	06830	Lock Collar 1"
15.6	18009	Pulley Cog T20 -25mm (Single) - Aluminum
15.7	18013	Boom Belt - Continuous Loop
15.8	07822	Idler Pulley (MS-AC52)
15.9	07231	Belt Tension Brace Top Brush (AC034-3)
15.10	07232	Belt Tension Bolt w/Machined End 1/2" x 4"
15.11	07816	Top Brush Rollers (MC-AC55)
15.12	07512	Bearing Flange 1-1/2" - 2 Hole



# Low Pressure Box

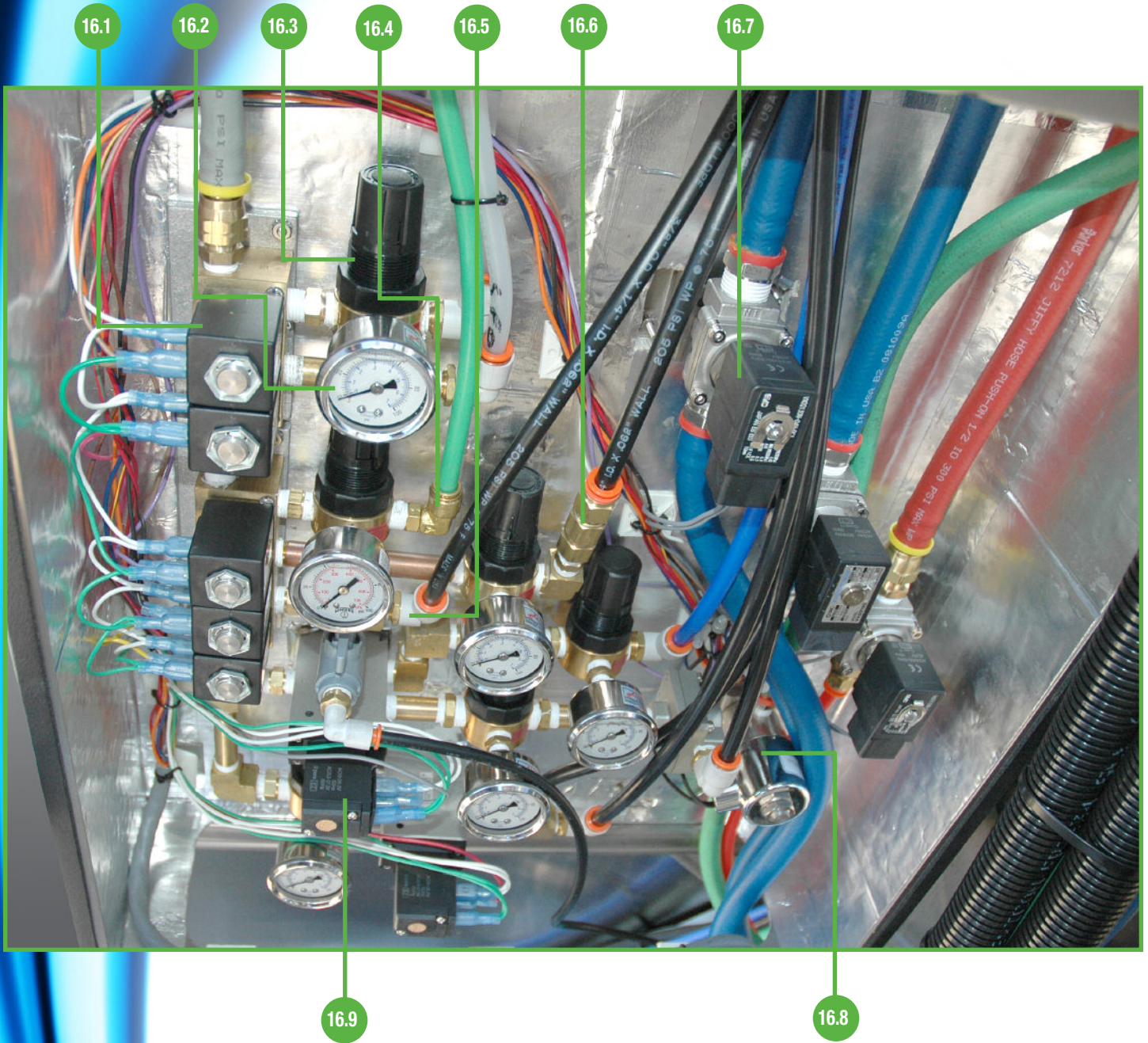

**Low Pressure Box**

ITEM #	PART #	DESCRIPTION
16.1	64021-42	2 Stage Solenoid
16.2	47027	0-100 Pressure Guage
16.3	58055	Regulator 1/4"
16.4	22-W169PL-6-4	3/8" X 1/4" Poly Push Lock Swivel - 90 Degree
16.5	22-W169PL-4-4	1/4" X 1/4" Poly Push Lock Swivel - 90 Degree
16.6	34018	Check Valve - Brass 1/4FX1/4F-SHMP
16.7	06520	Solenoid Valve - 1/2" , 24VAC
16.8	64071	Solenoid Valve - 0-150 1/4" SS
16.9	64000	Solenoid Air - 24VAC



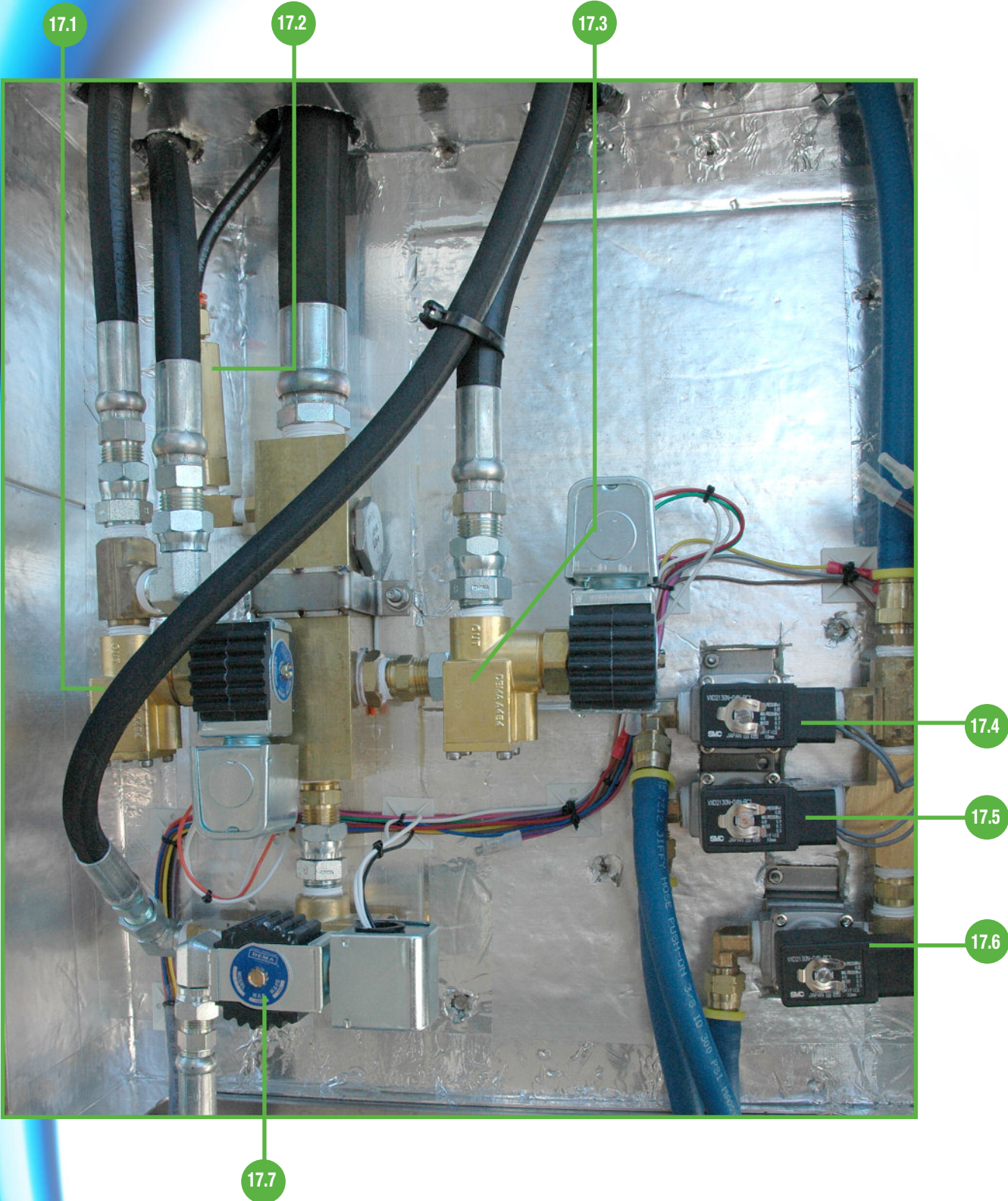

**High Pressure Box**

ITEM #	PART #	DESCRIPTION
17.1	31030	Dema Valve 454P
17.2	34000	Check Valve Brass Super 184"
17.3	31030	Dema Valve 454P
17.4	06520	Solenoid Valve - 1/2" , 24VAC
17.5	06520	Solenoid Valve - 1/2" , 24VAC
17.6	06520	Solenoid Valve - 1/2" , 24VAC
17.7	31030	Dema Valve 454P



# Gantry Electrical Panel- Lower

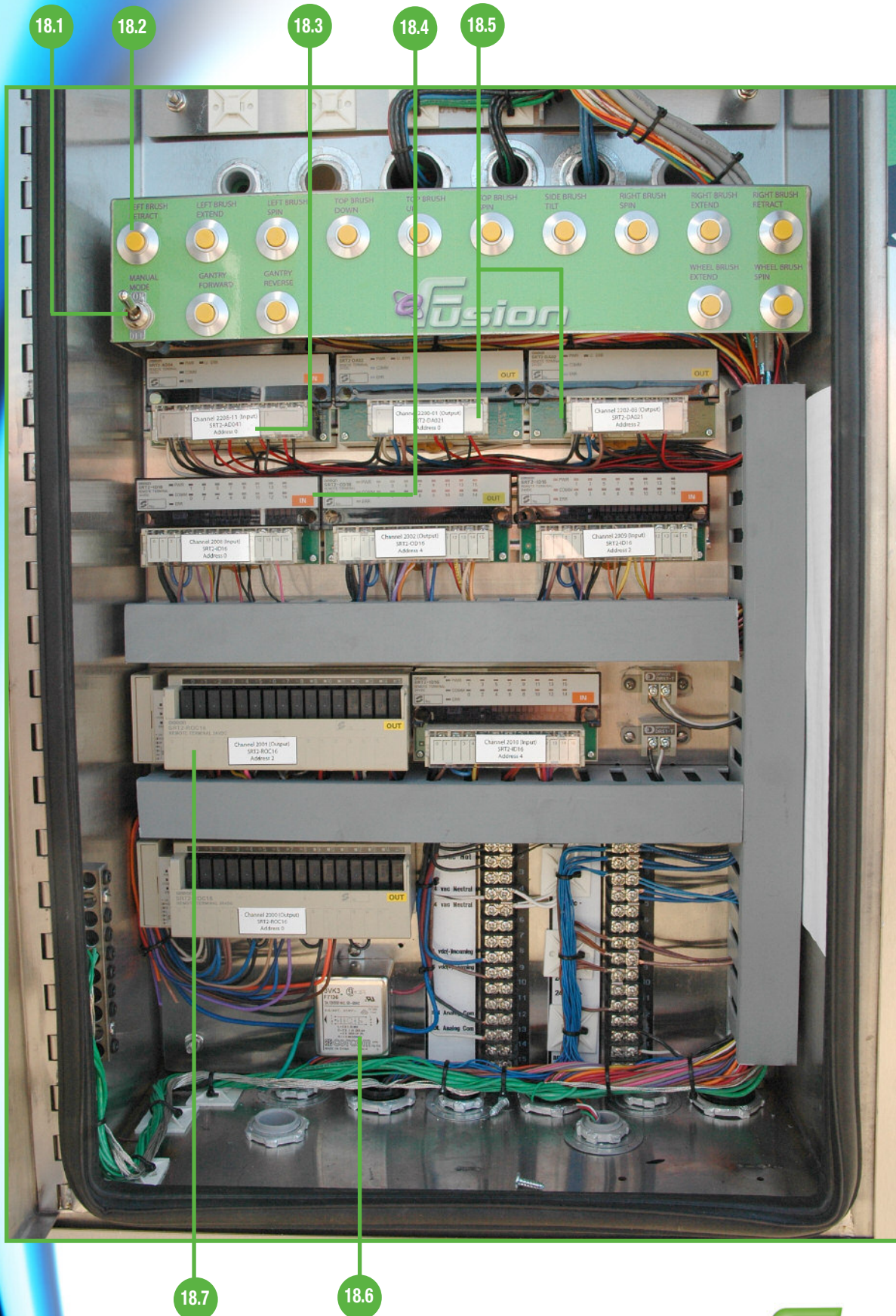

**Gantry Electrical Panel- Lower**

ITEM #	PART #	DESCRIPTION
18.1	40069	Switch, SPST (On-Off) 15A/120
18.2	72026	Push Button Switch (Yellow)
18.3	07524	Analog Input Card - SRTDA004
18.4	06920	Input Card - WW SRT2-ID16
18.5	07525	Analog Output Card - SRT2DA002
18.6	06785	Filter - 3VK3
18.7	06940	Relay Output Card - WW SRT2ROC16



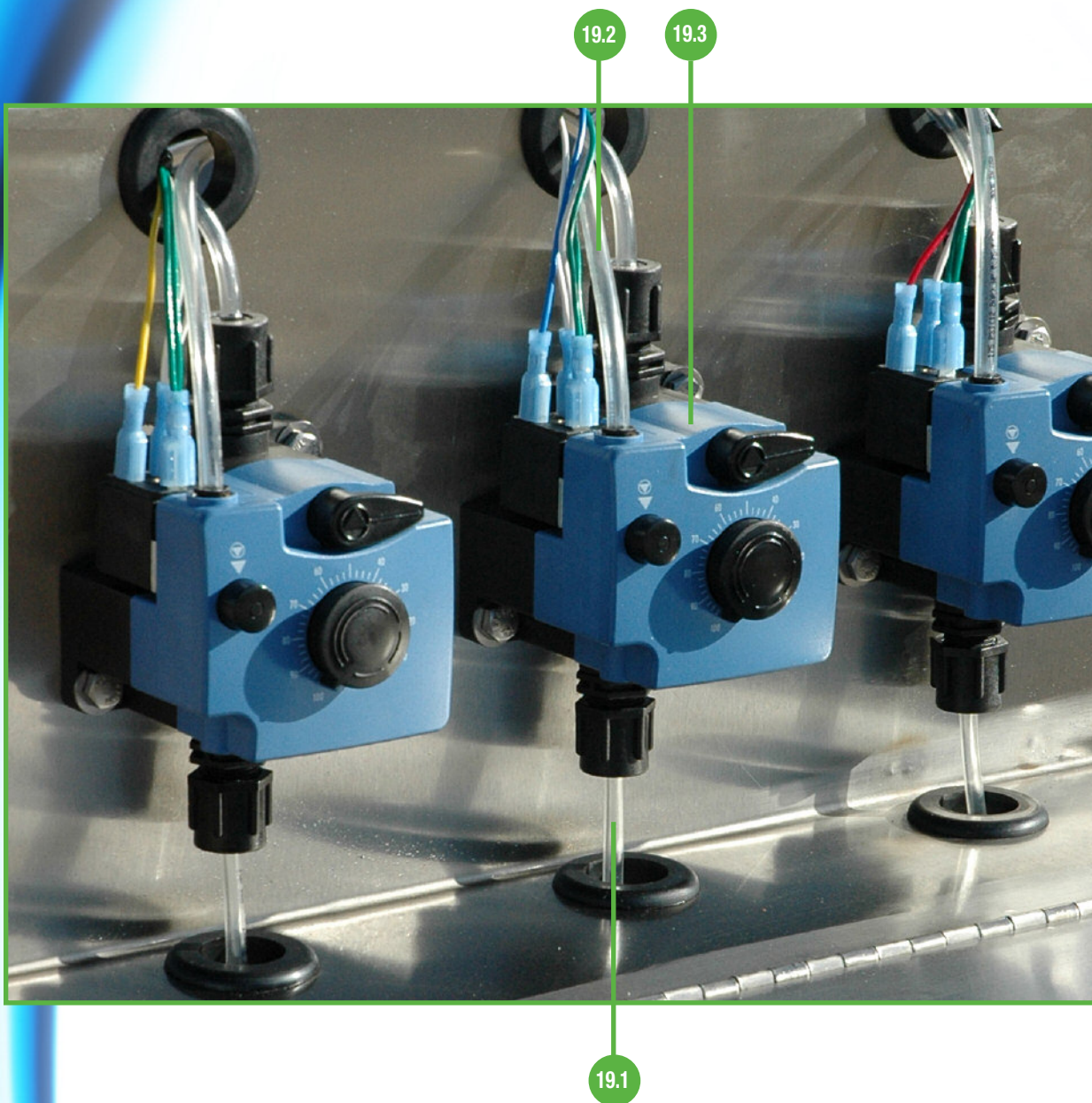

**Low Pressure Pumps**

ITEM #	PART #	DESCRIPTION
19.1	52109	Tubing Clear 3/8" OD x 1/4" ID
19.2	52110	Tubing Clear 1/4" OD x .160" ID
19.3	57020	Pneumatic Metering Pump 24VAC



# Pump Stand - Front End View

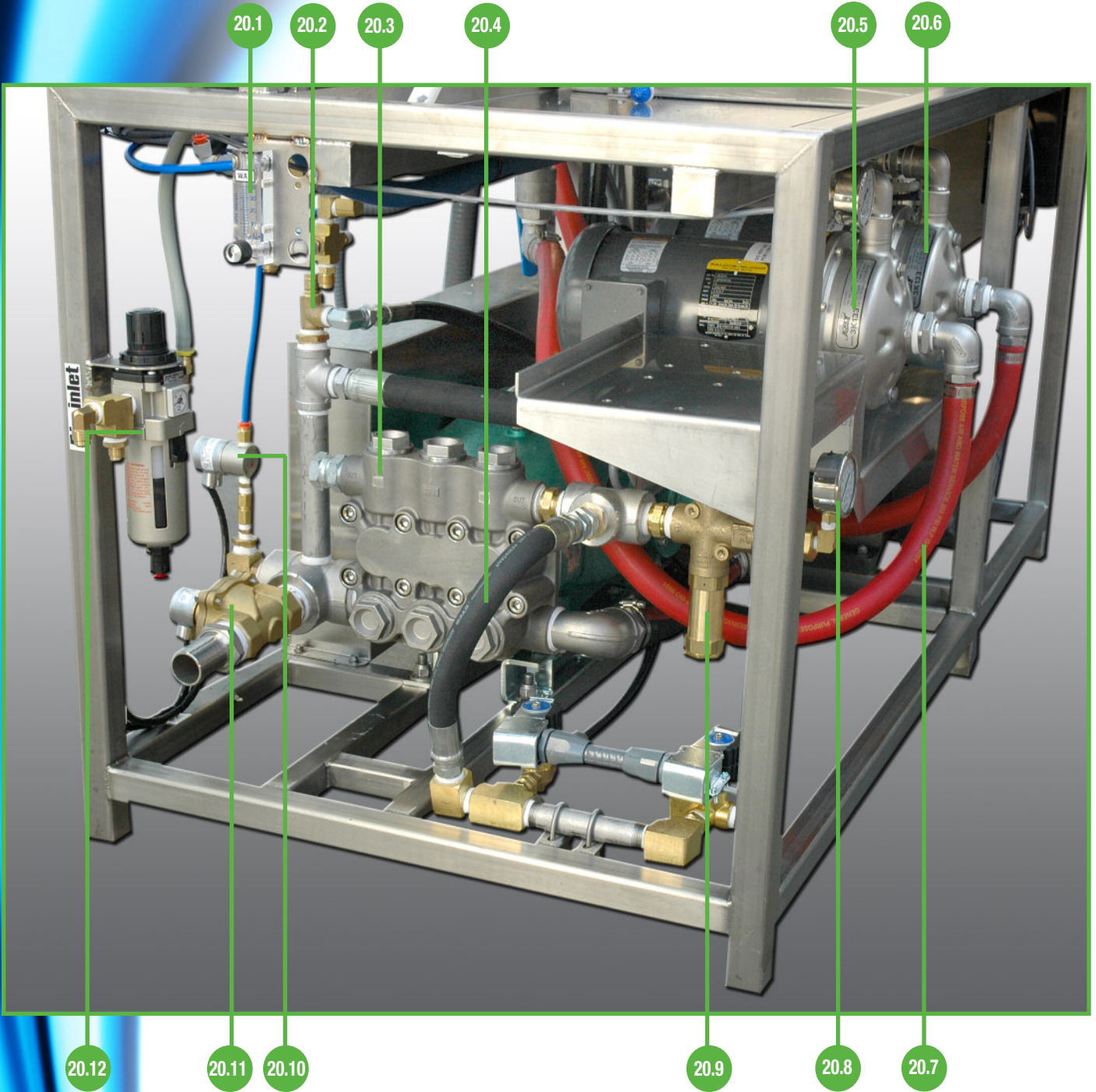

**Pump Stand - Front End View**

ITEM #	PART #	DESCRIPTION
20.1	47075	Flow Meter, 4-40 GPM
20.2	58022	Valve - Pressure Relief
20.3	35000	Pump , 36GPM (Arimitsu # 3612)
20.4	52816	3/4" x 19" Wire Braid Hose R1AT-12X19CW HU12-12MB E/E
20.5	32-3K133MT3	Pump, 2HP/3PH
20.6	32-3K133MT3	Pump, 2HP/3PH
20.7	52022	Hose-1" Push-Loc-Red
20.8	47025	0-3000 PSI LWR MT Gauge
20.9	06760	Unloader - 1"
12.10	64071	3BD7 Solenoid Valve 0-150 1/4" SS
20.11	64001	1-1/2" Solenoid Valve (Reclaim)
20.12	58090-2	Filter Regulator w/Guage & Auto Drain



# Pump Stand - CAT Pump

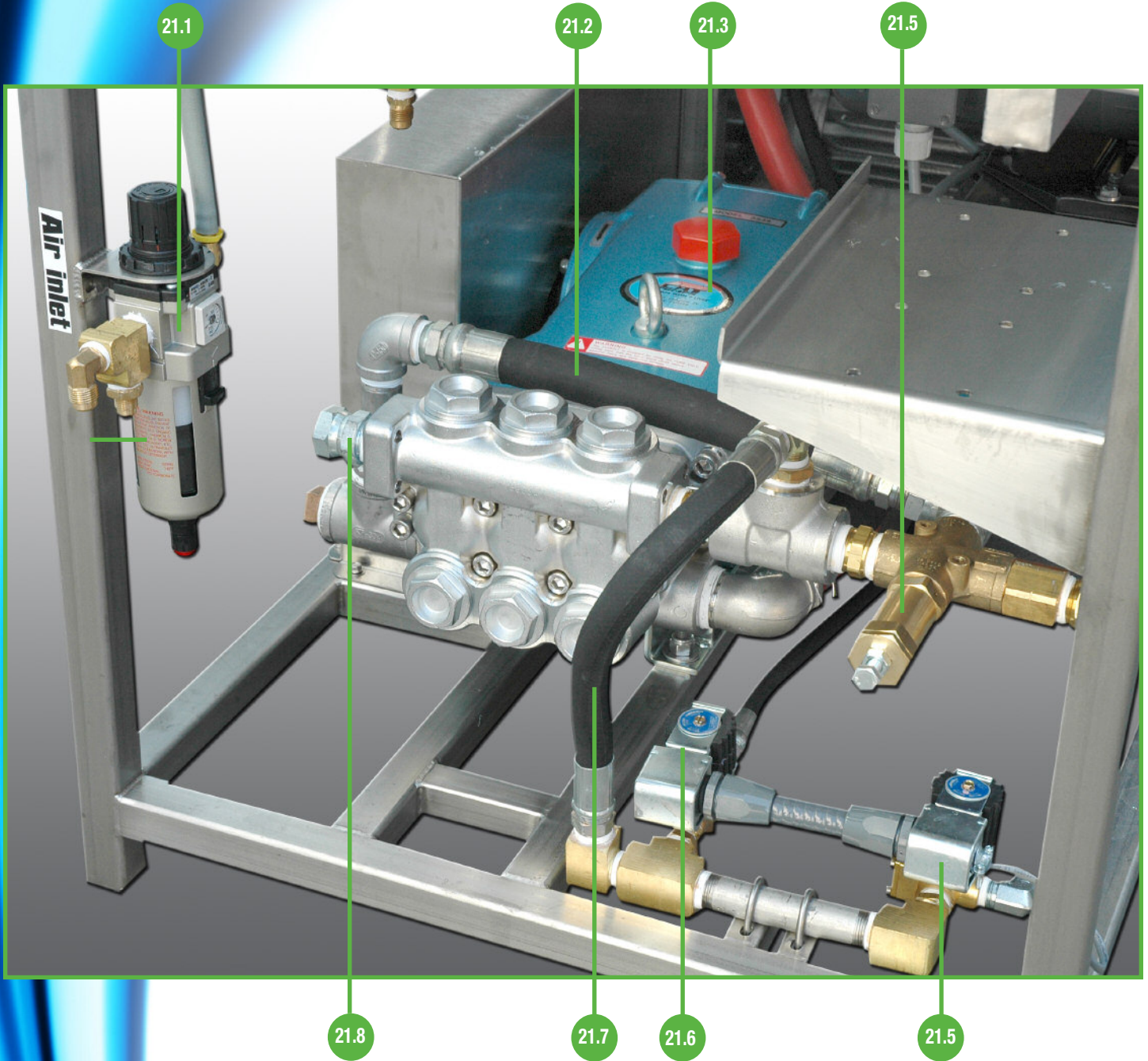

**Pump Stand - CAT Pump**

ITEM #	PART #	DESCRIPTION
21.1	58090-2	Filter Regulator w/Guage & Auto Drain
21.2	52801	1"x17-3/4" Wire Braid Hose R2AT-16X17-3/4CW HU16-16MB E/E
21.3	32-3535	Cat 3535 - 35PFR Pump - 36GPM
21.4	06760	Unloader - 1"
21.5	31030	454P Dema Valve 24VAC - 1/2"
21.6	31020	453P Dema Valve 24VAC - 3/8"
21.7	52816	3/4" x 19" Wire Braid Hose R1AT-12X19CW HU12-12MB E/E
21.8	22-0107-16-16	1" Male To Female Pipe Swivel



# Pump Stand - Lower Front

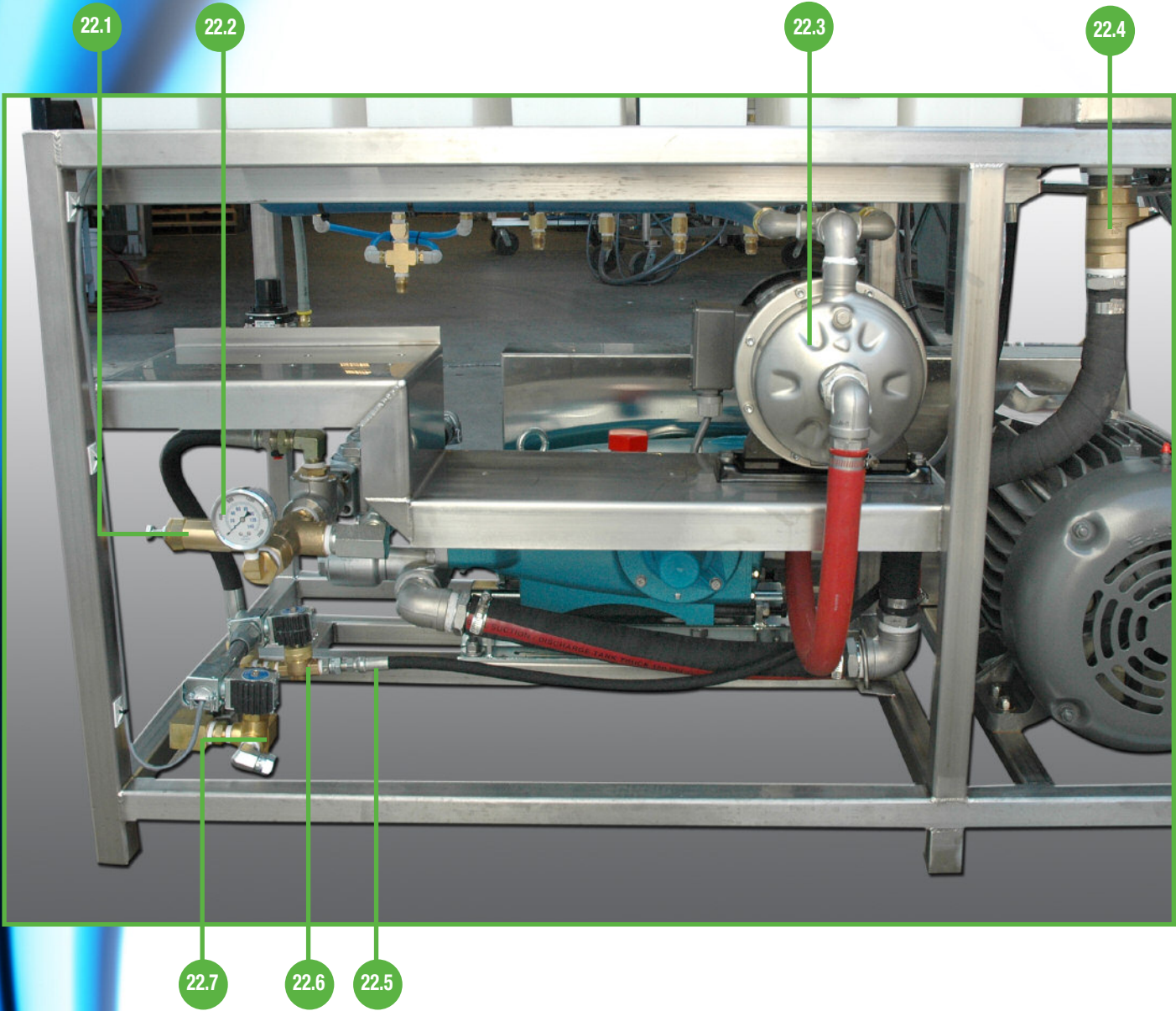

**Pump Stand - Lower Front**

ITEM #	PART #	DESCRIPTION
22.1	06760	Unloader - 1"
22.2	47025	0-3000 PSI LWR MT Gauge
22.3	32-3K133MT3	Pump, 2HP/3PH
22.4	22-V500P-24	Ball Valve - 1-1/2"
22.5	52819	3/8"x56" Wire Braid Hose R1AT-06X56CW HU06-06MB E/E
22.6	31020	453P Dema Valve 24VAC - 3/8"
22.7	31030	454P Dema Valve 24VAC - 1/2"



# Pump Stand - Rear

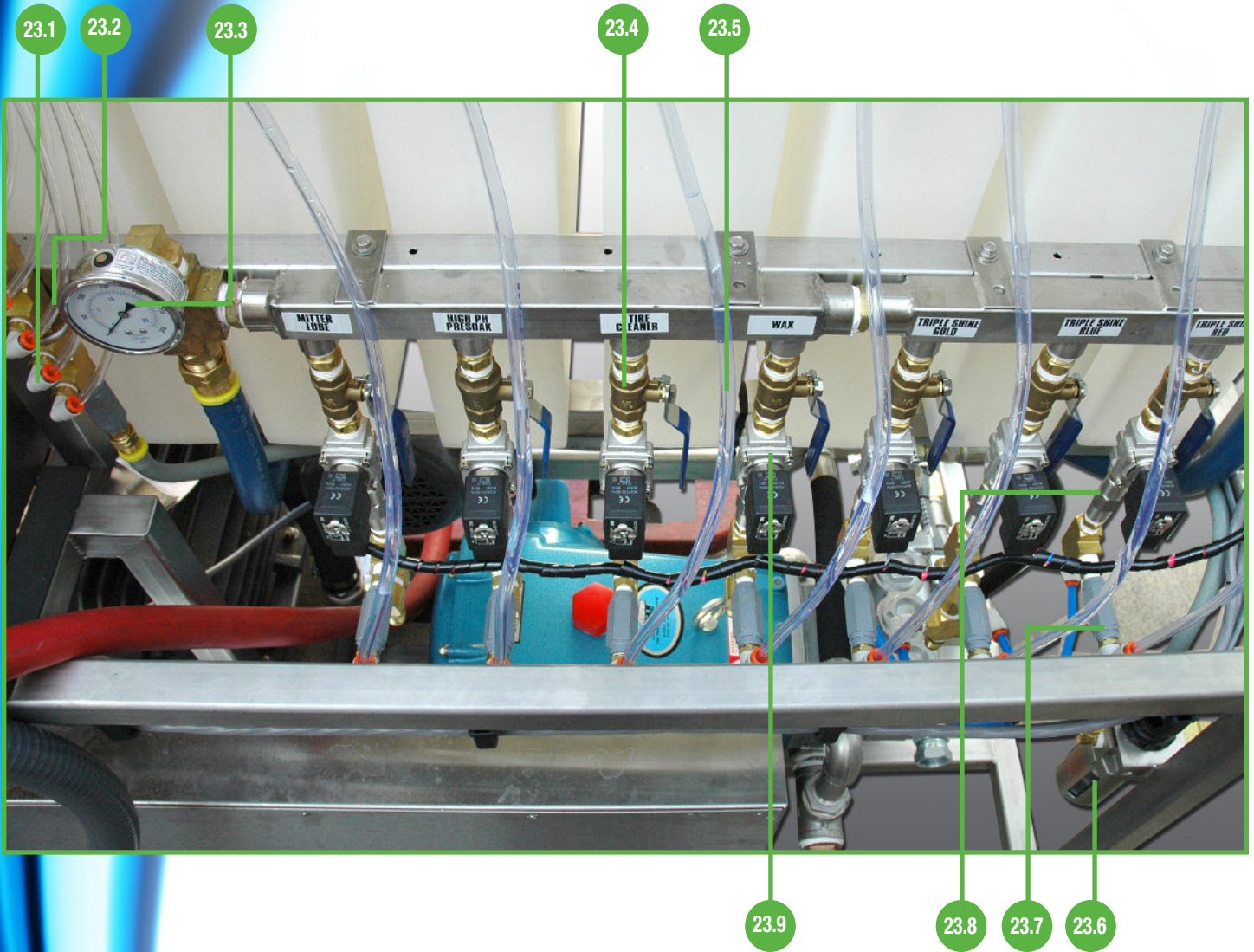

**Pump Stand - Rear**

ITEM #	PART #	DESCRIPTION
23.1	22-W169PL-4-4	Tube 1/4 x 1/4P 90 Connect SWV
23.2	52110	Tubing Clear 1/4" OD x .160" ID
23.3	47010	Gauge, Press 0/300 PNL
23.4	22-V500P-8	Ball Valve 1/2" Brass
23.5	52109	Tubing Clear 3/8" OD x 1/4" ID
23.6	58090-2	Filter Regulator w/Guage & Auto Drain
23.7	34025	Check Valve - Poly 1/4"
23.8	34022	Check Valve , 3/8" SS F/F
23.9	06520	Solenoid Valve - 1/2" , 24VAC
23.1	22-W169PL-4-4	Tube 1/4 x 1/4P 90 Connect SWV
23.2	52110	Tubing Clear 1/4" OD x .160" ID
23.3	47010	Gauge, Press 0/300 PNL
23.4	22-V500P-8	Ball Valve 1/2" Brass
23.5	52109	Tubing Clear 3/8" OD x 1/4" ID
23.6	58090-2	Filter Regulator w/Guage & Auto Drain
23.7	34025	Check Valve - Poly 1/4"
23.8	34022	Check Valve , 3/8" SS F/F
23.9	06520	Solenoid Valve - 1/2" , 24VAC



# Control Panel - Pump Stand

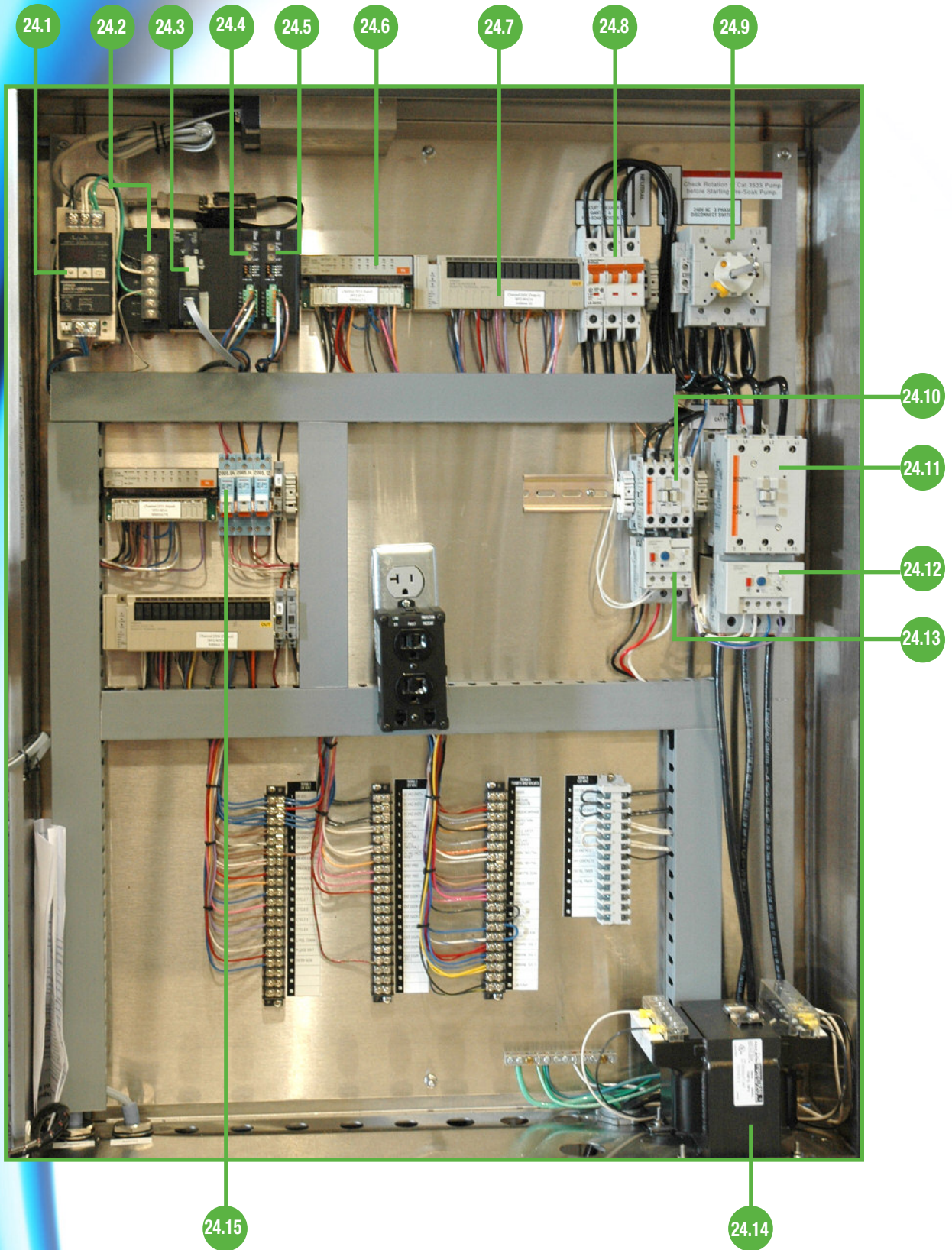

**Control Panel - Pump Stand**

ITEM #	PART #	DESCRIPTION
24.1	06960	DC Power Supply - Omron
24.2	06680-3	PWR 5V & 24VDC Out 100-240VAC (CJ1WPA202)
24.3	07503	CPU (Fusion)
24.4	06680-2	CJ1 - COMPOBUS/S Master
24.5	06680-2	CJ1 - COMPOBUS/S Master
24.6	06920	Input Card - WW SRT2-ID16
24.7	06940	Relay Output Card - WW SRT2ROC16
24.8	40027-2	3P - 30 Amp Breaker (L9-30/3/C)
24.9	06994	Main Disconnect - 100 Amp
24.10	60056	Contact, 16AMP, 4 Pole
24.11	60065	Contact, 85AMP, 4 Pole 120V
24.12	60066-1	Overload, 18-90 Amp
24.13	60062-1	Overload, 3.2-16 Amp
24.14	40190-5	Transformer 500VA - 120/240-24V
24.15	06948	Relay



# Gantry Control Panel - Upper

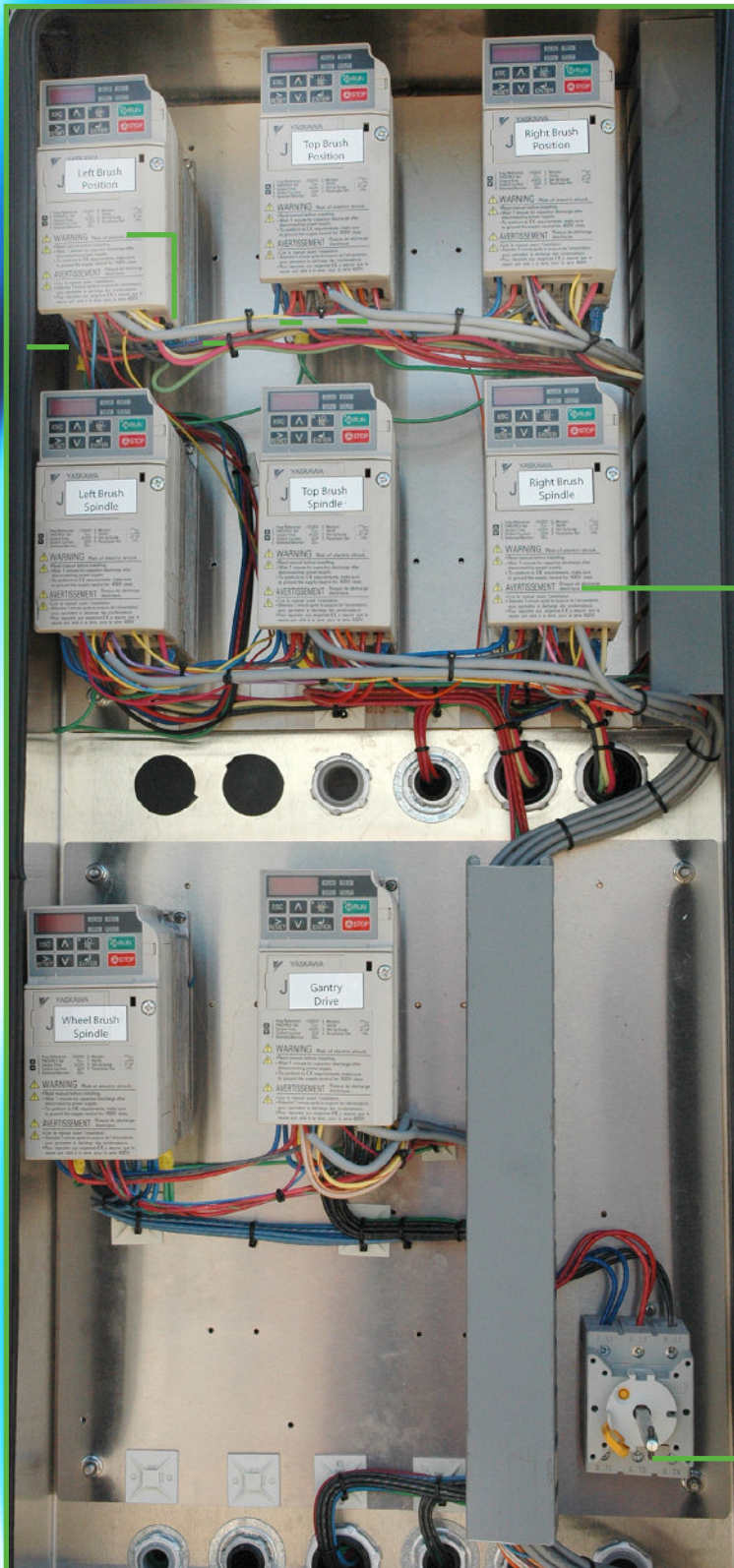

25.1

25.2

**Gantry Control Panel - Upper**

ITEM #	PART #	DESCRIPTION
25.1	06973	Drive, 1HP/230V/5A/3PH/50-60HZ
25.2	06995	63AMP Disconnect Base Mount





# ***NOTES***



# ***NOTES***







5842 W. 34th Street Houston, Texas 77092  
800-999-9878 713-683-9878 Fax: 713-683-9624