

Pumps

stand

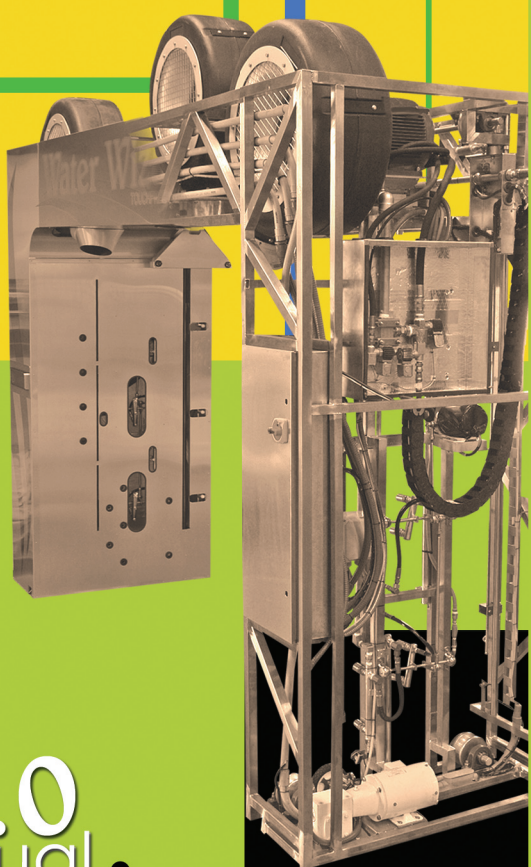

WATER WIZARD 2.0

parts manual

● parts department
1.866.927.4229
713.590.6652.fax
www.jcolemanco.com

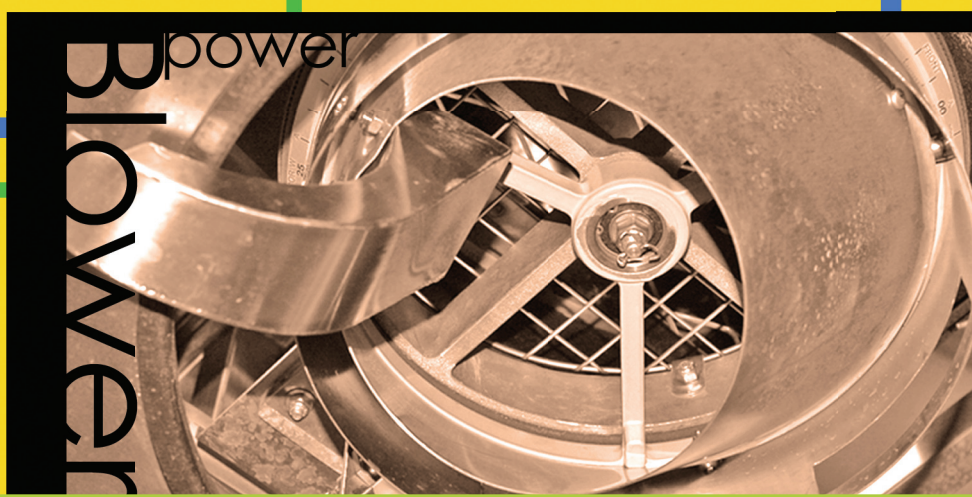

power
Blower

(Revised August 2005)



Please Read

The equipment shown on the following pages is from a typical Water Wizard 2.0 automatic system. The purpose of this manual is to simplify the process and increase the accuracy when ordering parts. Please note that with the variety of options available, your equipment may have additional components or not have some of the components shown.

In the interest of product improvement, Jim Coleman Company reserves the right to make equipment modifications at any time and without advance notice

For more information on the Water Wizard 2.0 and other world class car wash equipment and parts manufactured by Jim Coleman Company please contact us at:

1.800.999.9878
5842 W. 34th Street
Houston, Texas 77092
www.jcolemanco.com

Parts Department Direct Line:
1.866.927.4229
Fax: 713.590.6652

WATER WIZARD 2.0® Parts Manual

<u>Table of Contents</u>		Page
Pump Stand		
Pump Stand	Front View	06
Pump Stand	Low and High Pressure Pumps	08
Pump Stand	End View – Pump Side	10
Pump Stand	Rear View	12
Electrical Control Center	Door	14
Electrical Control Center	Components	16
Gantry		
Gantry	Entrance View	20
Gantry	Exit View	22
Gantry	Control Panel	24
Gantry	Passenger Side (W/O Cover)	26
Gantry	Driver Side (W/ Cover)	28
Gantry	Passenger Side – Lower	30
Gantry	Passenger Side – Drive Motor Assembly	32
Gantry	Passenger Side – Upper	34
Gantry	Passenger Side – High Pressure Manifold Box	36
Gantry	Passenger Side – Boom Belt, Shaft & Prox Assembly	38
Gantry	Passenger Side – Lower Prox	40
Gantry	Driver Side (W/ Cover)	44
Gantry	Driver Side – Lower	46
Gantry	Driver Side – Upper	48
Gantry	Driver Side Low Pressure Manifold	50
Gantry	Driver Side – Boom Tilt Assembly	52
Gantry	Driver Side – Oscillating Assembly	54
Gantry	Spray Nozzles	56
Gantry	Zero Degree Nozzle Rocker Panel Assembly	58
Gantry	Presoak Foamers	60
Gantry	Blower Control Box – Top of Gantry	62
Wash Boom	(W/O Cover)	64
Wash Boom	Oscillating Assembly	66
Wash Boom	Solenoid and Oscillators	68
Gantry	Oscillating Blower System	70
Gantry	Panel Doors (Both Sides)	72
Gantry	Height Adjustment / Contouring Eyes – Driver's Side	74
Gantry	Height Adjustment / Contouring Eyes – Passenger's Side	76

pump stand





PUMP STAND

PUMP STAND

ID#	PART#	DESCRIPTION
1.1	N/A	Repair Kit – Reclaim Valve
1.2	64001	Reclaim Valve -1 1/2" Solenoid Valve
1.3	22-0188-24-24	1 1/2" Hose Barb
1.4	58090-1	1/2" Air Regulator
1.5	47075	Flow Meter – Wax/Soap
1.6	06534-D	7 Compartment Chemical Tank Decal
1.7	06534	7 Compartment Chemical Tank
1.8	47010	0-300 psi Panel Mount Gauge
1.9	06535	Clean Water Tank
1.10	55267	25hp Motor
1.11	32-3k133mt3	Pump/Motor - Presoak
1.12	31030	454 P Dema 24 VAC 1/2"
1.13	55013	1/3 hp Motor - Tire Cleaner
1.14	31020	453 P Dema 24 VAC 3/8"
1.15	55016	1/2 hp Motor - Triple Shine

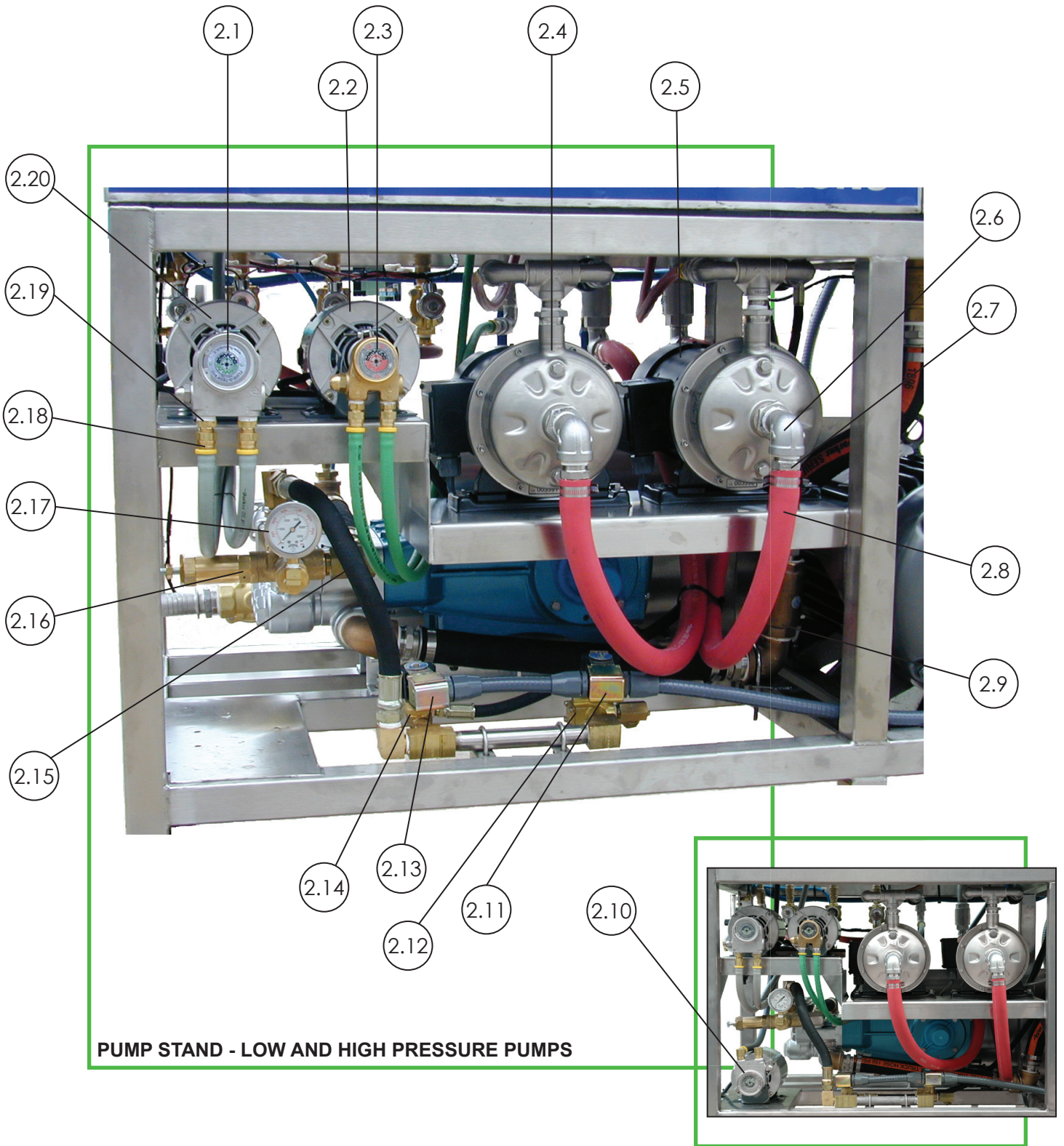

PUMP STAND - LOW and HIGH PRESSURE PUMPS

ID#	PART#	DESCRIPTION
2.1	57007	240 gph pump
2.2	55013	1/3 hp Motor
2.3	57002	100 gph pump
2.4	32-3k133mt3	Pump - Presoak
2.5	32-3k133mt3	2 hp Motor
2.6	22099	SS Street Ell
2.7	22-0188-16-16	1" SS MPT Hose Barb
2.8	N/A	1" Hose
2.9	52017	1/2" Wire Braid Hose (Return to Tank)
2.10	57007	240 gph Hot Wax pump
2.11	31061	Dema Coil Assy. 24 VAC
2.12	31030	454 Dema 24 VAC 1/2"
2.13	31061	Dema Coil Assy. 24 VAC
2.14	31020	453P Dema 24 VAC 3/8"
2.15	52186	3/4" Wire Braid Hose (Undercarriage Inlet)
2.16	6760	1" General Unloader
2.17	47025	0-3000 psi LWR MT Gauge
2.18	22-30682-8-8B	1/2" Brass FM SW
2.19	22-48F-8-8	1/2" X 1/2" Male Connector
2.20	55016	1/2 hp Motor

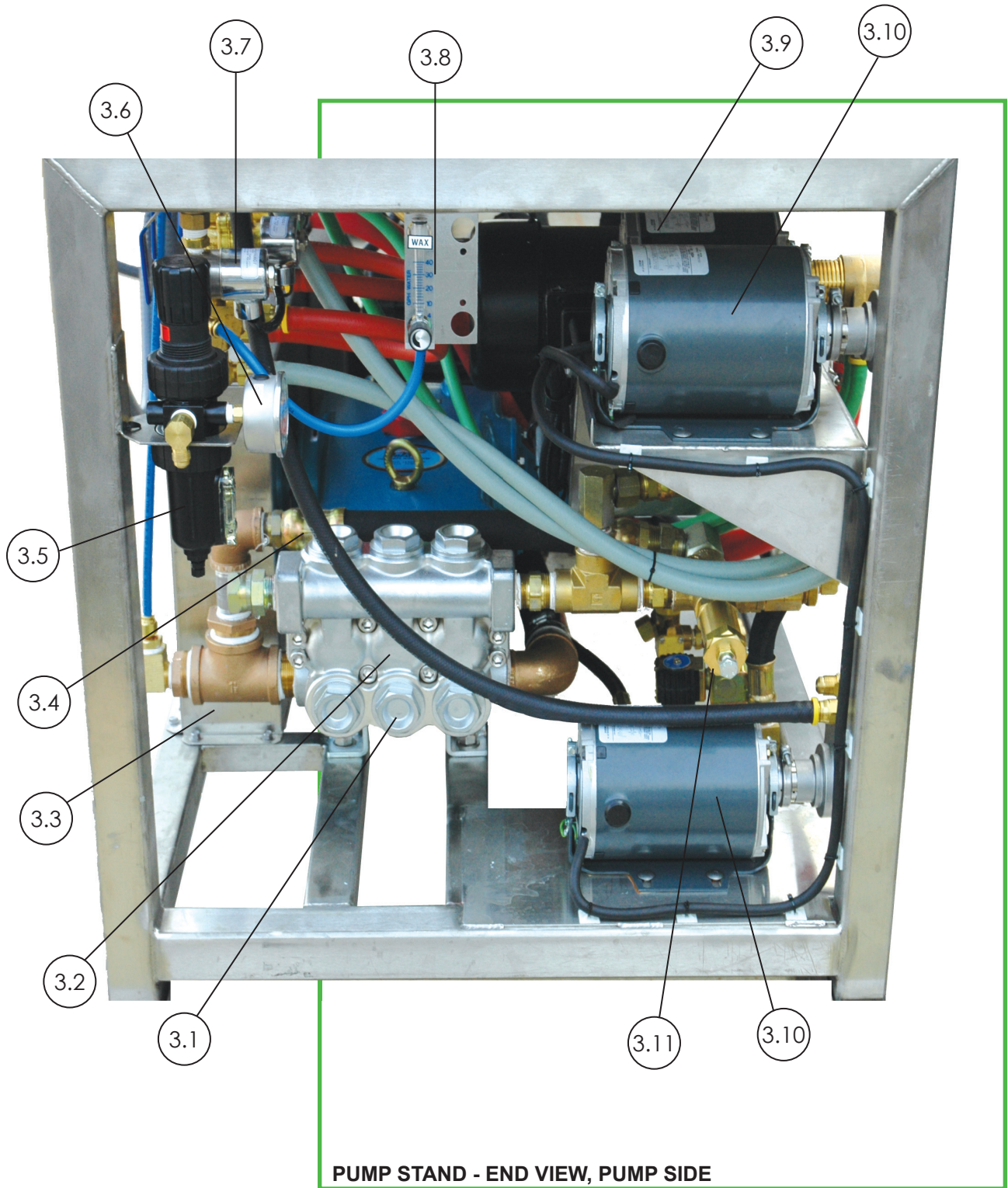

PUMP STAND – END VIEW, PUMP SIDE

ID#	PART#	DESCRIPTION
3.1	32-34235	3535 Cat Pump Valve Kit
3.2	32-3535	3535 Cat Pump
3.3	18385	Wizard Belt Guard
3.4	N/A	1" Crossover HP Hose
3.5	58090-1	1/2" Air Regulator
3.6	47010	0-300 psi Panel Mount Gauge
3.7	64071	1/4" 24 VAC N.C. Solenoid
3.8	47075	Flow Meter – Wax/Soap
3.9	55013	1/3 hp motor (tire cleaner)
3.10	55016	1/2 hp Motor (triple shine and hot wax)
3.11	6760	1" Unloader

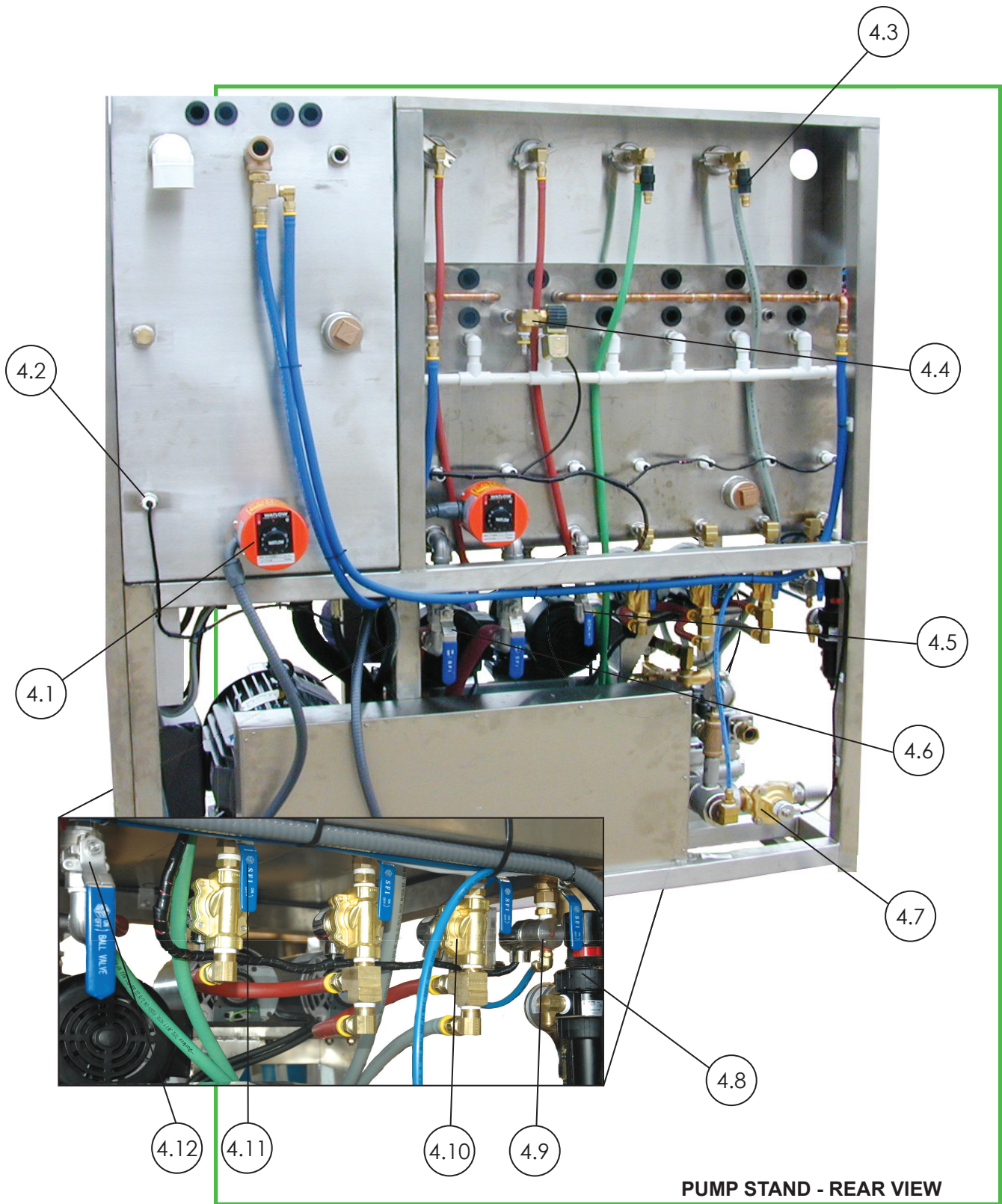

PUMP STAND – REAR VIEW

ID#	PART#	DESCRIPTION
4.1	96225	4.5 kw Heater 240 volts
4.2	72050	Side Mount Level Switch
4.3	34020	6936F6F 3/8" Poly Check Valve
4.4	06520	1/2" Solenoid Valve (recirculating presoak)
4.5	22450	1/2" SS Ball Valve
4.6	22101	1" SS Ball Valve
4.7	64001	Reclaim Valve 1 1/2"
4.8	58090-1	1/2" Air Regulator
4.9	64071	1/4" 24V N.C. Solenoid
4.10	64070	1/2" Solenoid Valve (triple shine)
4.11	22-V500P-8	1/2" Brass Ball Valve
4.12	22450	1/2" SS Ball Valve
4.13	96225	4.5 kw Heater - 240 Volts
	or	
	96210	9 kw Heater - 240 Volts



ELECTRICAL CONTROL CENTER

ID#	PART#	DESCRIPTION
5.1	72026	Push Button Switch (Yellow)
5.2	06681	Red Lion Operator Interface G303
5.3	06601	Electrical Control Center Decal
5.4	6997	Switch Handle Assembly – Yellow/Red
5.5	24384	Cam Lock

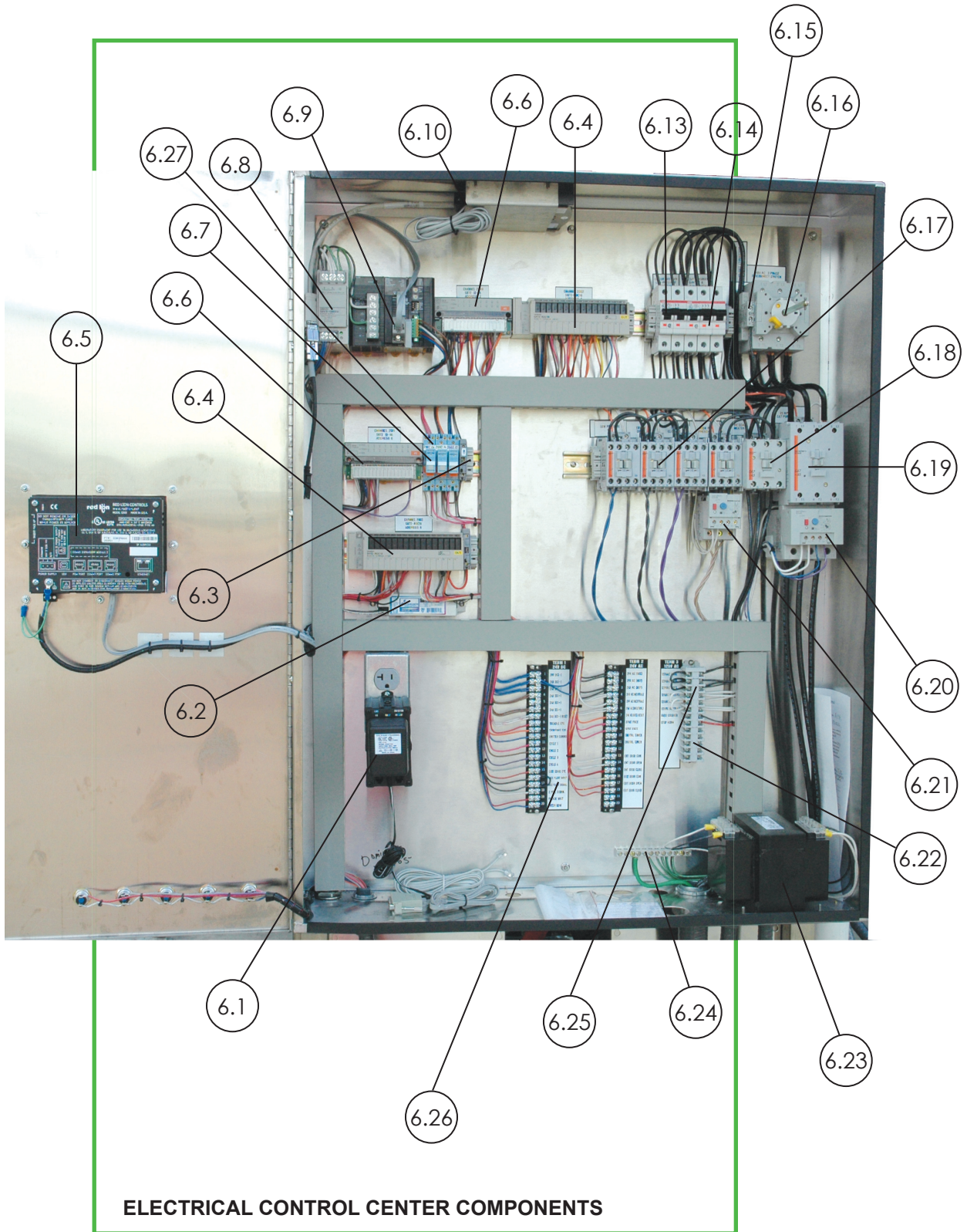

ELECTRICAL CONTROL CENTER COMPONENTS

ID#	PART#	DESCRIPTION
6.1	33150	Surge Protector
6.2	42080	LED Drive
6.3	40340-2	24v 5amp fuse holder
6.4	06940	SRT2ROC 16 Relay Output Card
6.5	6611	Red Lion Operator Interface
6.6	06920	SRT2ID 16 Input Card
6.7	06948	Relay
6.8	06960	DC Power Supply
6.9	6680-1, 6680-2, 6680-3	CPU (three components)
6.10	33567	Modem
6.13	40074	2P 16 amp Breaker
6.14	40027, 40029	3P 20 amp Breaker, 3P 40 amp Breaker
6.15	06996, 06951	Auxiliary Switch--Domestic, International
6.16	06994	Main Disconnect – 100 amp
6.17	60056	CA 1610 Contactor
6.18	60058	43 amp Contactor
6.19	60065	85 amp Contactor
6.20	60066-1	Overload - 90 amp
6.21	60062-1	Overload - 3.2 – 16 amp
6.22	40066-6	Terminal Strip
6.23	40190-5, 40190-6	500VA 120/240-24 volt Transformer--Domestic, 240/120—Int.
6.24	40116	Grounding Bar
6.25	40066-5	Terminal Strip
6.26	40010-3	Terminal Strip 20pt
6.27	06949	Relay Socket

gantry





GANTRY - ENTRANCE VIEW

Gantry - Entrance View

ID#	PART#	DESCRIPTION
1.1	6100	Scrolling Message Sign
1.2	6671	Skin (Driver Side) Entrance End (A267)
1.3	6645	Skin Inside Panel (Driver Side) (A135)
1.4	6659	Radiused Panel (Driver Side) (With Blower) (A294D)
1.4	6666	Radiused Panel (Driver Side) (Without Blower) (A278D)
1.5	6675	Skin (Top Middle) Entrance End (A273)
1.6	6654	Overhead Panel (With Blower) (A293)
1.6	6657	Overhead Panel (Without Blower) (A277)
1.7	6667	Radiused Panel (Passenger Side) (With Blower) (A294P)
1.7	6668	Radiused Panel (Passenger Side) (Without Blower) (A278P)
1.8	6673	Skin (Passenger Side) Entrance End (A268)
1.9	6646	Inside Panel (Passenger Side) (A136)
1.10	6997	Switch Handle Assembly – Yellow/Red



GANTRY - EXIT VIEW

GANTRY – EXIT VIEW

ID#	PART#	DESCRIPTION
2.1	6607	Eye Can – Passenger Side (A0252)
2.2	6674	Skin Passenger Side Exit End (A265)
2.3	6676	Skin Top Middle Exit End (A133)
2.4	6672	Skin Driver Side Exit End (A266)
2.5	6606	Eye Can – Driver Side (A0253)

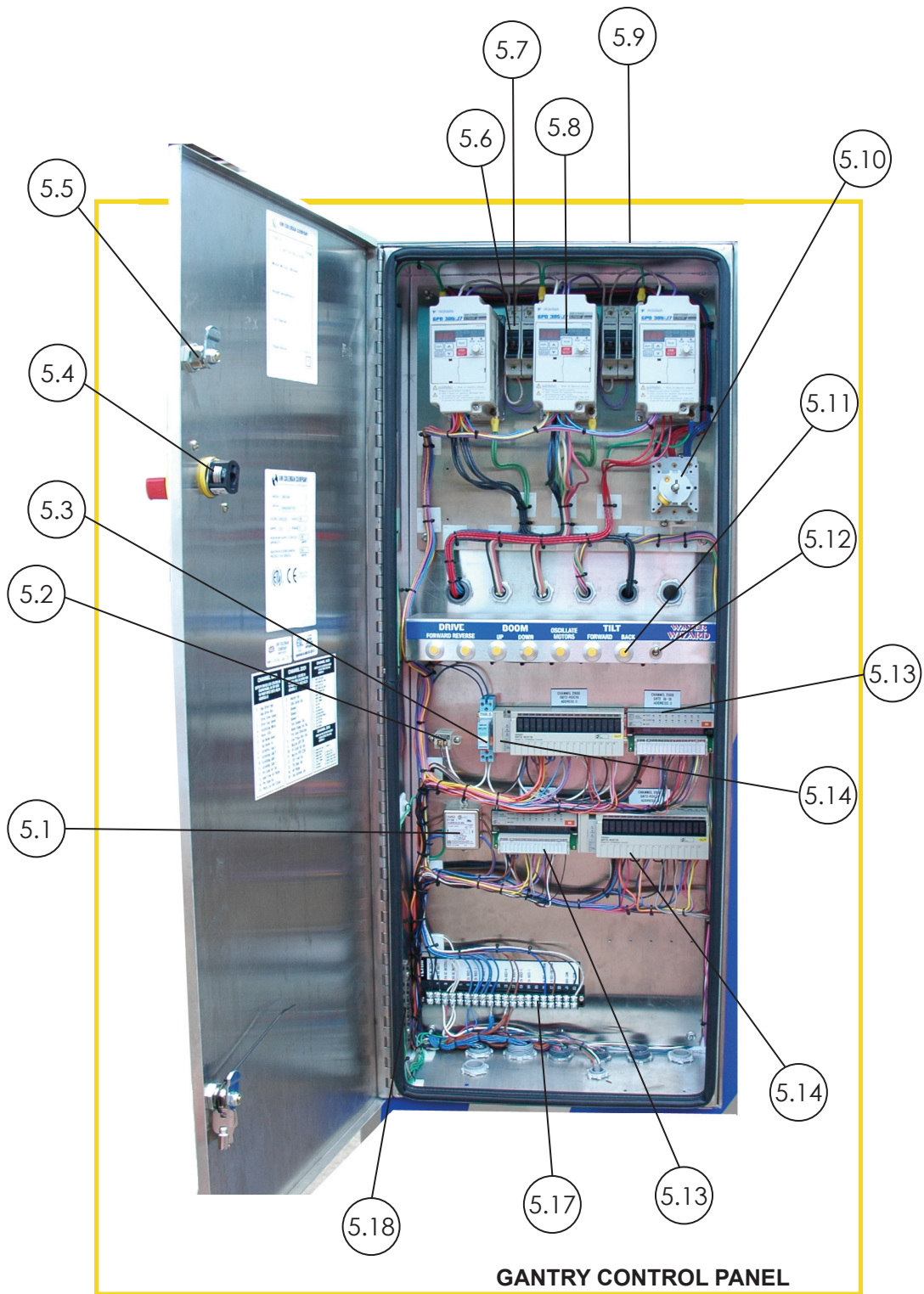

GANTRY CONTROL PANEL

GANTRY CONTROL PANEL

ID#	PART#	DESCRIPTION
5.1	6785	DC Filter – 3VK3
5.2	6950	Terminating Resistor
5.3	6948	Relay 24 ADC
5.4	6997	Switch Handle Assembly – Yellow/Red
5.5	24385	Cam Lock
5.6	40032-6	5 amp fuse
5.7	40112-30	Fuse Holder
5.8	6698	Omron Yaskawa Variable Speed Drive - 230V
5.9	93121	Door Gasket
5.10	6995	63 amp Disconnect Base Mount
5.11	72026	Push Button – Yellow
5.12	40069	On/Off Switch
5.13	6920	Input Card – SRT2-ID16
5.14	6940	Relay Output Card – SRT2-ROC16
5.17	40010-3	Terminal Strip 20pt
5.18	40446	Ground Bar 10pt

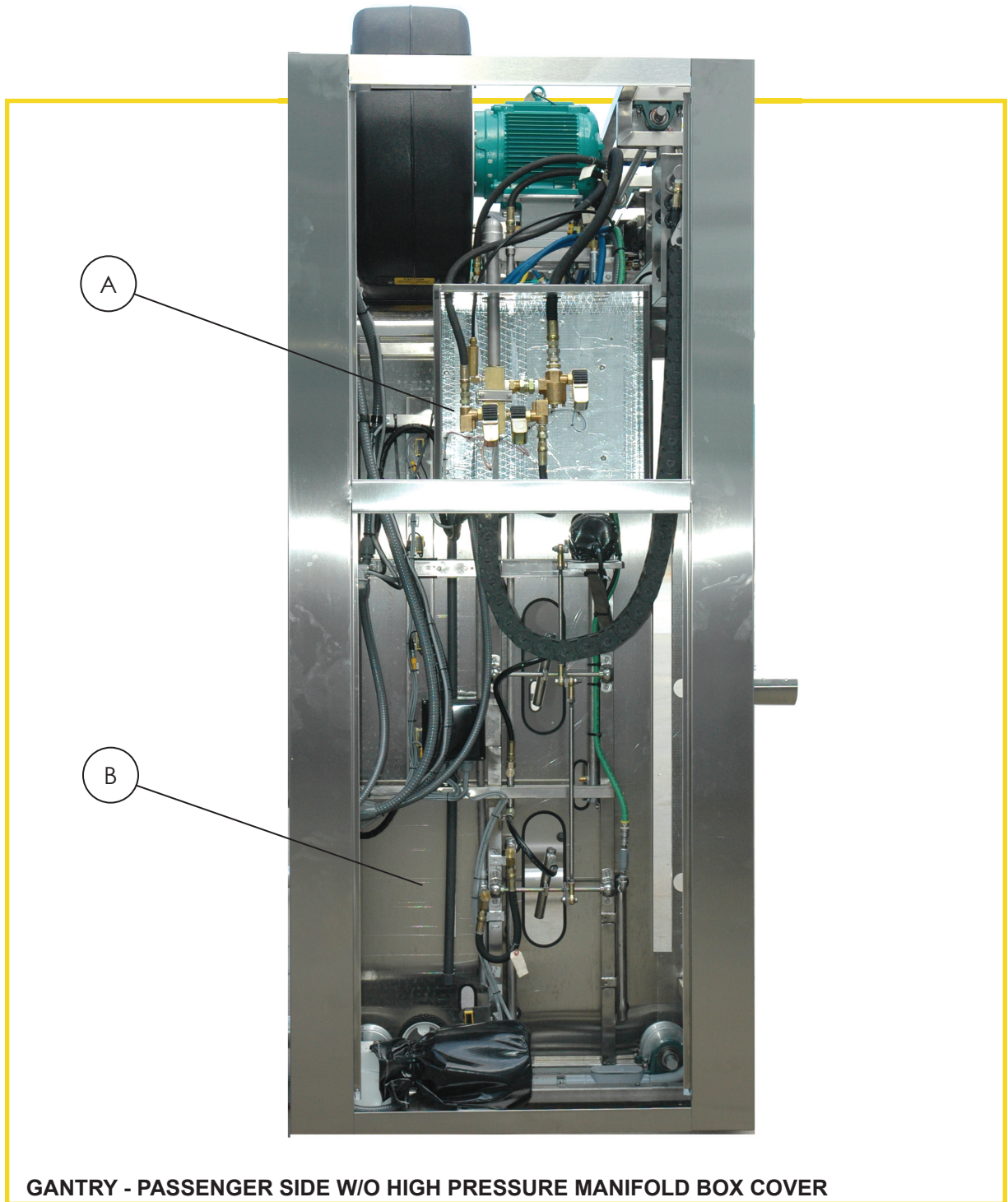

GANTRY - PASSENGER SIDE W/O HIGH PRESSURE MANIFOLD BOX COVER

Gantry – Passenger Side w/o High Pressure Manifold Box Cover

- A High Pressure Manifold Box – See page 40
- B Passenger Side – See page 34

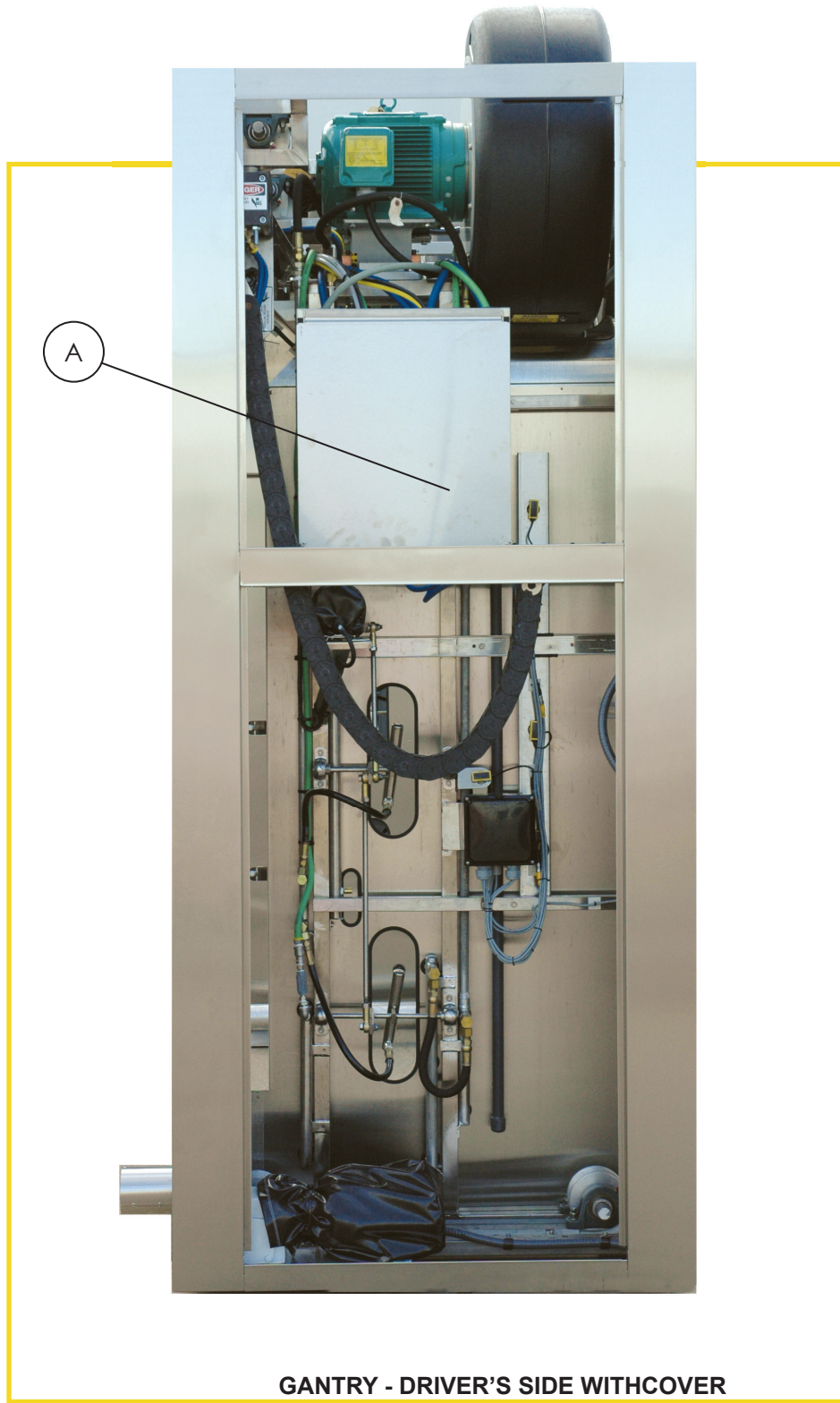

GANTRY - DRIVER'S SIDE WITHCOVER

Gantry – Driver’s Side w/ Low Pressure Manifold Box Covered

A Low Pressure Manifold Box – See page 54

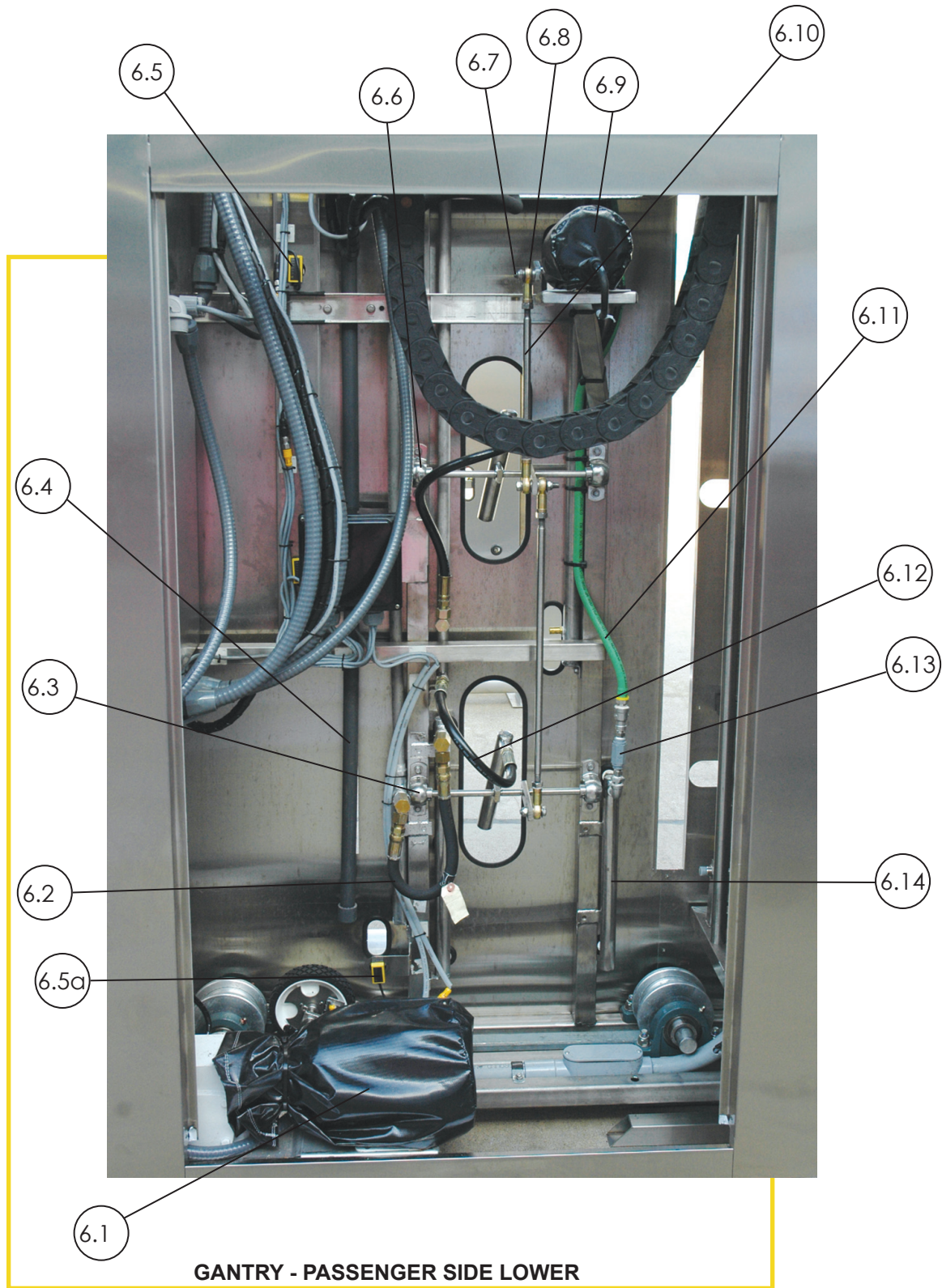

GANTRY – PASSENGER SIDE LOWER

ID#	PART#	DESCRIPTION
6.1	55230-2	Drive Motor w/cover
6.2	52803	1/2" Wire Hyd. Hose – 18" with 1/2" Male pipe on each end
6.3	6647	Pillow Block Bearing - Oscillator
6.4	22010	Tri-Foam (PVC) Pipe 3/4"
6.5	6741	Receiver Eye – Contouring
6.5a	6741	Receiver Eye - Measurement
6.6	6647	Pillow Block Bearing - Oscillator
6.7		7/16" Nut
6.8	6838	7/16" Rod End
6.9	55236-1	Oscillating Motor With Gear Box
6.10	6500-OR-12	Oscillator Rod – Top Side – 12 3/8"
6.11	52012-2	Push Lock Hose 3/8" Green
6.12	52010	Synflex 3/8" X 19" hose
6.13	34025	Check Valve – Poly 1/4"
6.14	6616	Tire Cleaner Spray Manifold (6500TCP)

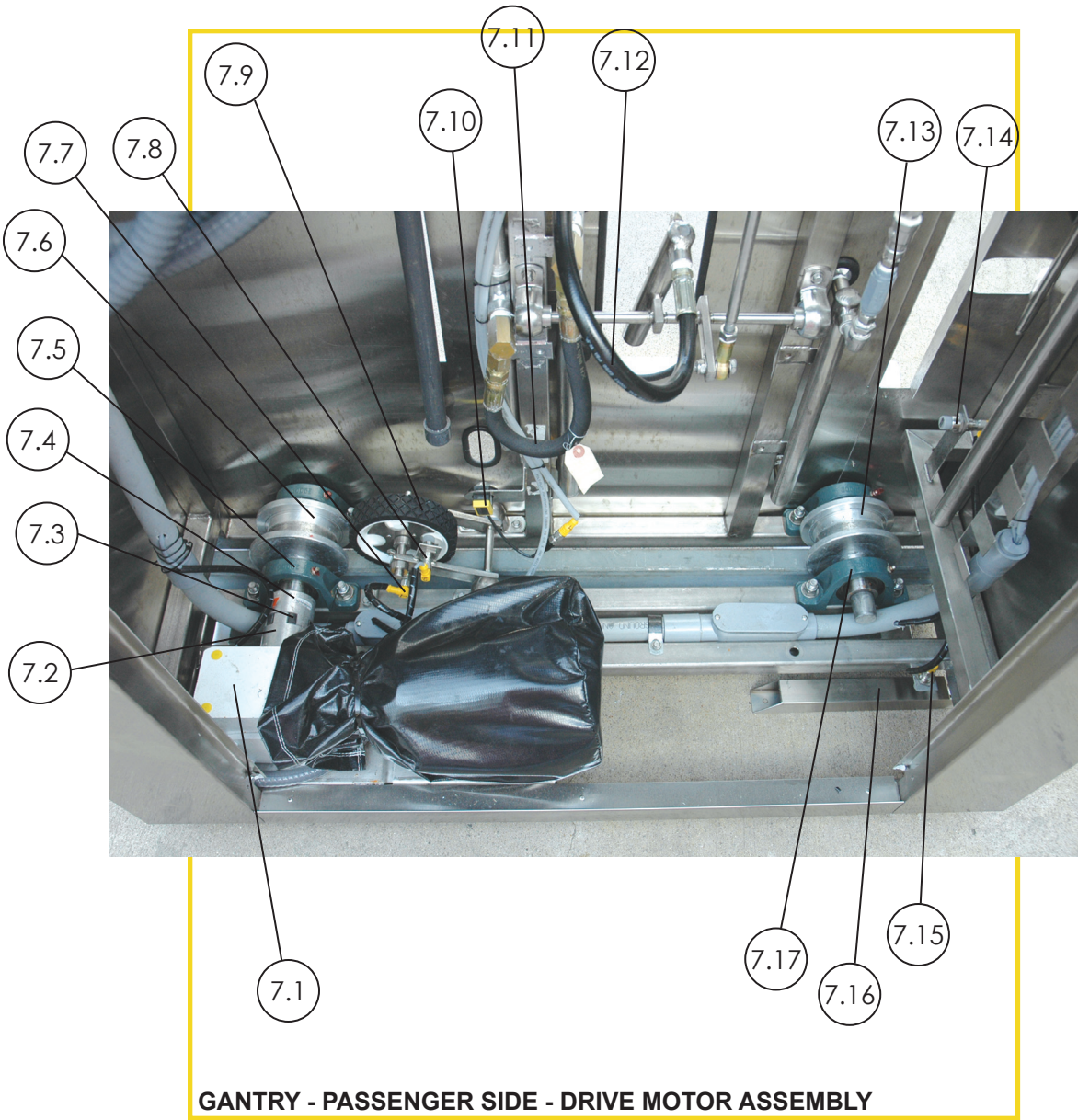

GANTRY – PASSENGER SIDE – DRIVE MOTOR ASSEMBLY

ID#	PART#	DESCRIPTION
7.1	55225-1	Gear Box – Drive Motor
7.2	6801	Love Joy 7/8" for Gear Box
7.3	6803	Love Joy Spider
7.4	6805	Love Joy 1 1/4" for Wheel Shaft
7.5	6851	1 1/4" Bearing Pillow Block VPS-120
7.6	6500-W	Drive Wheel
7.7	6650-4	Prox Cable – 90 Degree
7.8	6626	Prox – 18mm
7.9	6780	Count Wheel 2" X 5"
7.10	6741	Reciever Eye - Measurement
7.11	52803	1/2" Wire Hyd. Hose – 18" with 1/2" Male pipe on each end
7.12	52010	Synflex 3/8" X 19" hose
7.13	6500-W	Idler Wheel
7.14	6626	Prox – 18mm
7.15	6650-4	Prox Cable – 90 Degree
7.16	6613	Prox Target – home and end of track
7.17	6851	1 1/4" Bearing Pillow Block VPS-120

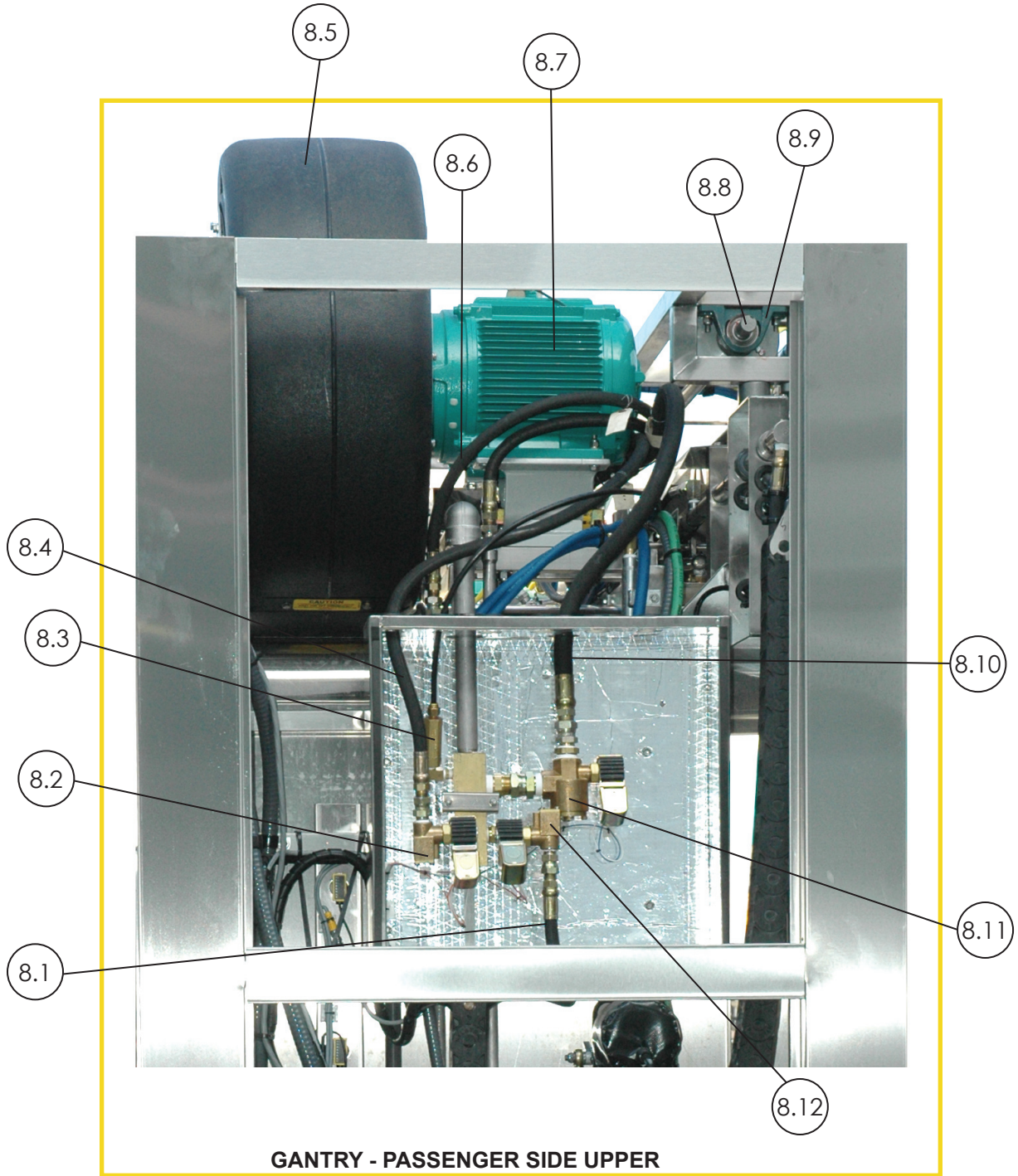

GANTRY – PASSENGER SIDE UPPER

ID#	PART#	DESCRIPTION
8.1	52017	1/2" Wire Braided Hose
8.2	31030	Dema Valve 454P – Side Spray
8.3	34000	Brass Check Valve – 1/4"
8.4	52017	1/2" Wire Braided Hose
8.5	19814	Blower Fan Housing
8.6	52017	1/2" Wire Braided Hose
8.7	55260	10hp 3ph Blower Motor
8.8	6500BSL	Boom Drive Shaft – Passenger Side
8.9	6850	Bearing Pillow Block VPS-116 – 1"
8.10	52186	3/4" 2WB Wrapped Hose
8.11	31040	Dema Valve 458P – Rocker Panel
8.12	31030	Dema Valve 454P – Top Boom

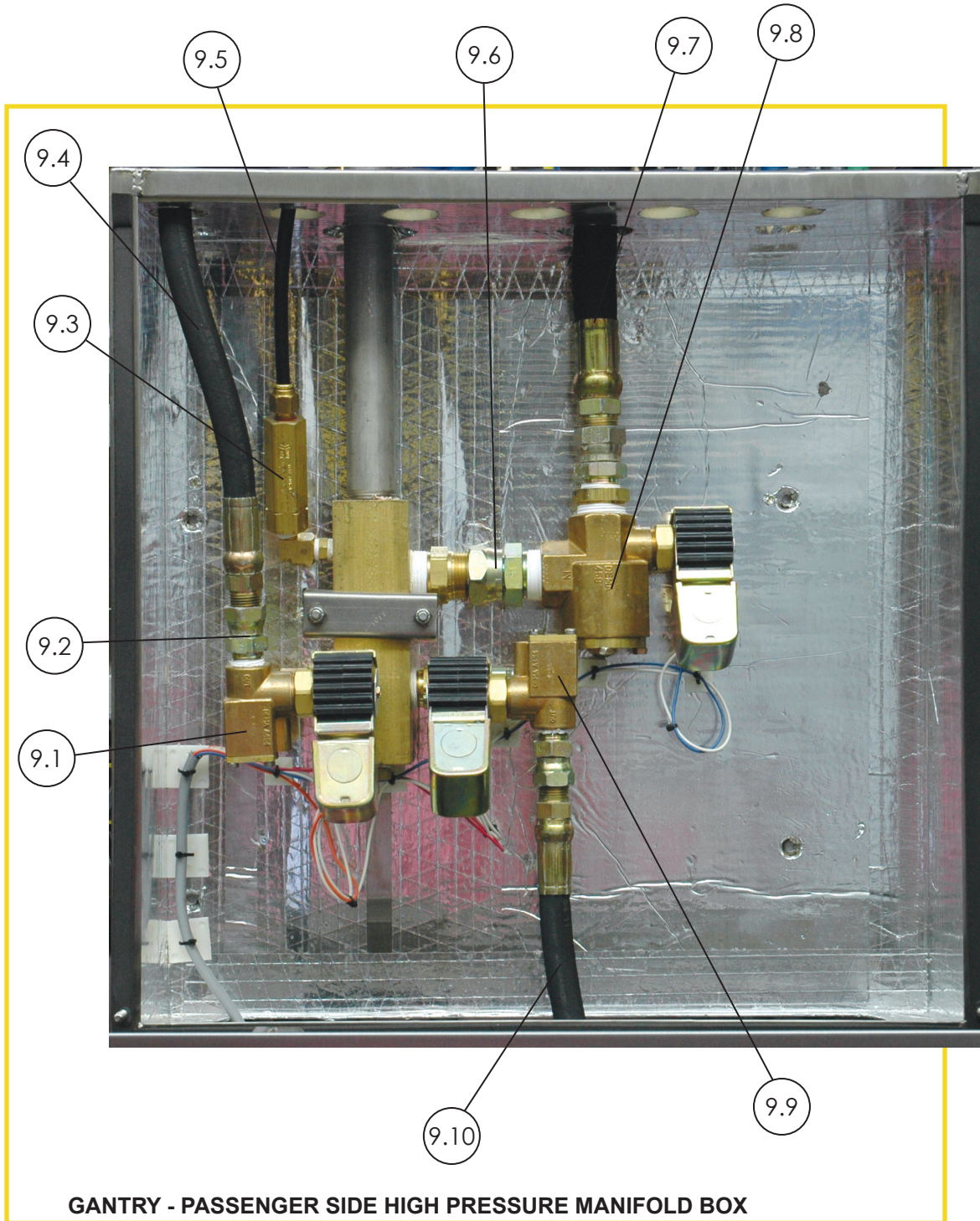

GANTRY – PASSENGER SIDE HIGH PRESSURE MANIFOLD BOX

ID#	PART#	DESCRIPTION
9.1	31030	Dema Valve 454P – Side Spray
9.2	22-0107-8-8	1/2" M X 1/2" F SW
9.3	34000	Check Valve Brass Super 1/4"
9.4	52017	1/2" Wire Braided Hose
9.5	22-EB-64-0500	3/8" Poly Flow Tube
9.6	22-0107-16-16	1" M X 1" F SW
9.7	52186	3/4" 2WB Wrapped Hose
9.8	31040	Dema Valve 458P 1" – Rocker Panel
9.9	31030	Dema Valve 454P – Top Boom
9.10	52017	1/2" Wire Braided Hose

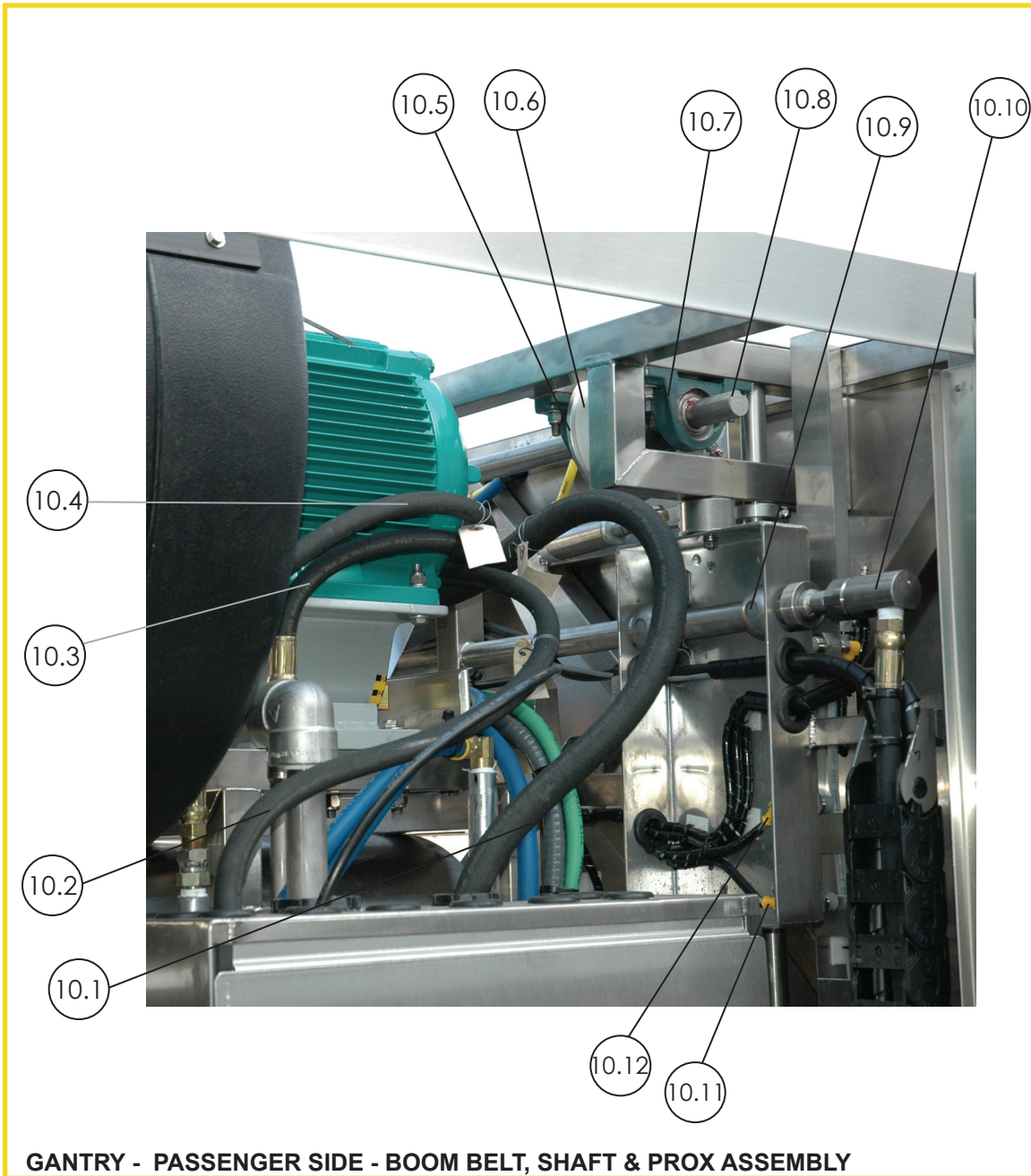

GANTRY – PASSENGER SIDE – BOOM BELT, SHAFT and PROX ASSEMBLY

ID#	PART#	DESCRIPTION
10.1	52186	3/4" 2WB Wrapped Hose
10.2	52017	1/2" Wire Braided Hose
10.3	52017	1/2" Wire Braided Hose
10.4	52017	1/2" Wire Braided Hose
10.5	6605	Boom Pulley (AM002)
10.6	6852-8	Kevlar Boom Belt - 8'
10.7	6850	Bearing Pillow Block VPS-116 – 1"
10.8	6500-BSL	Boom Drive Shaft – Passenger Side
10.9	6645-1	1-1/8" Poly-Hi Tivar P.B.
10.10	74005	1/2" Super Swivel
10.11	6650-6	Prox Cable – 90 Degree
10.12	6650-6	Prox Cable – 90 Degree

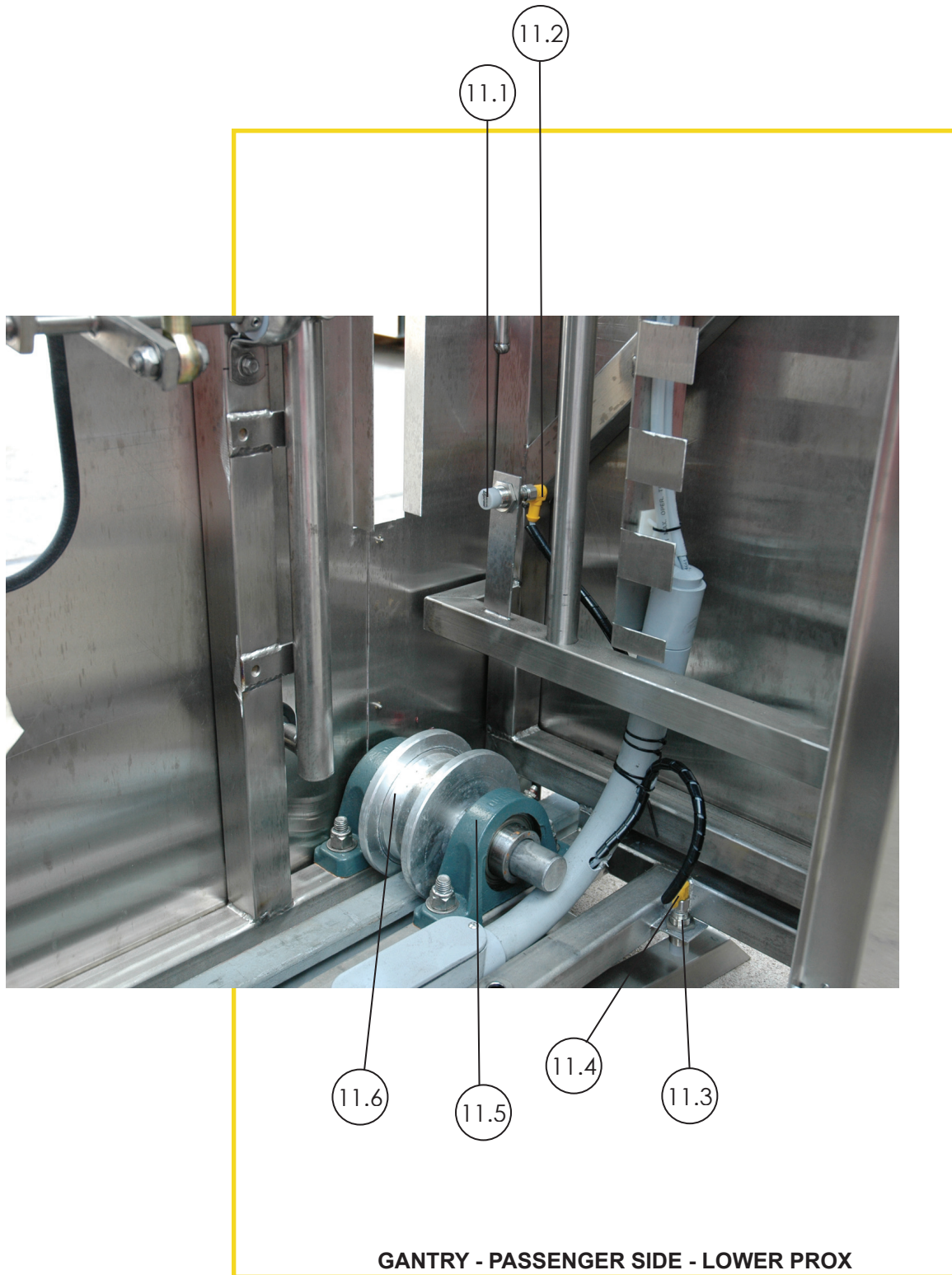

GANTRY – PASSENGER SIDE – LOWER PROX

ID#	PARTS#	DESCRIPTION
11.1	6626	Prox – 18mm
11.2	6650-4	Prox Cable – 90 Degree
11.3	6626	Prox – 18mm
11.4	6650-4	Prox Cable –90 Degree
11.5	6851	1 1/4” Bearing Pillow Block VPS-120
11.6	6500-W	Drive Wheel

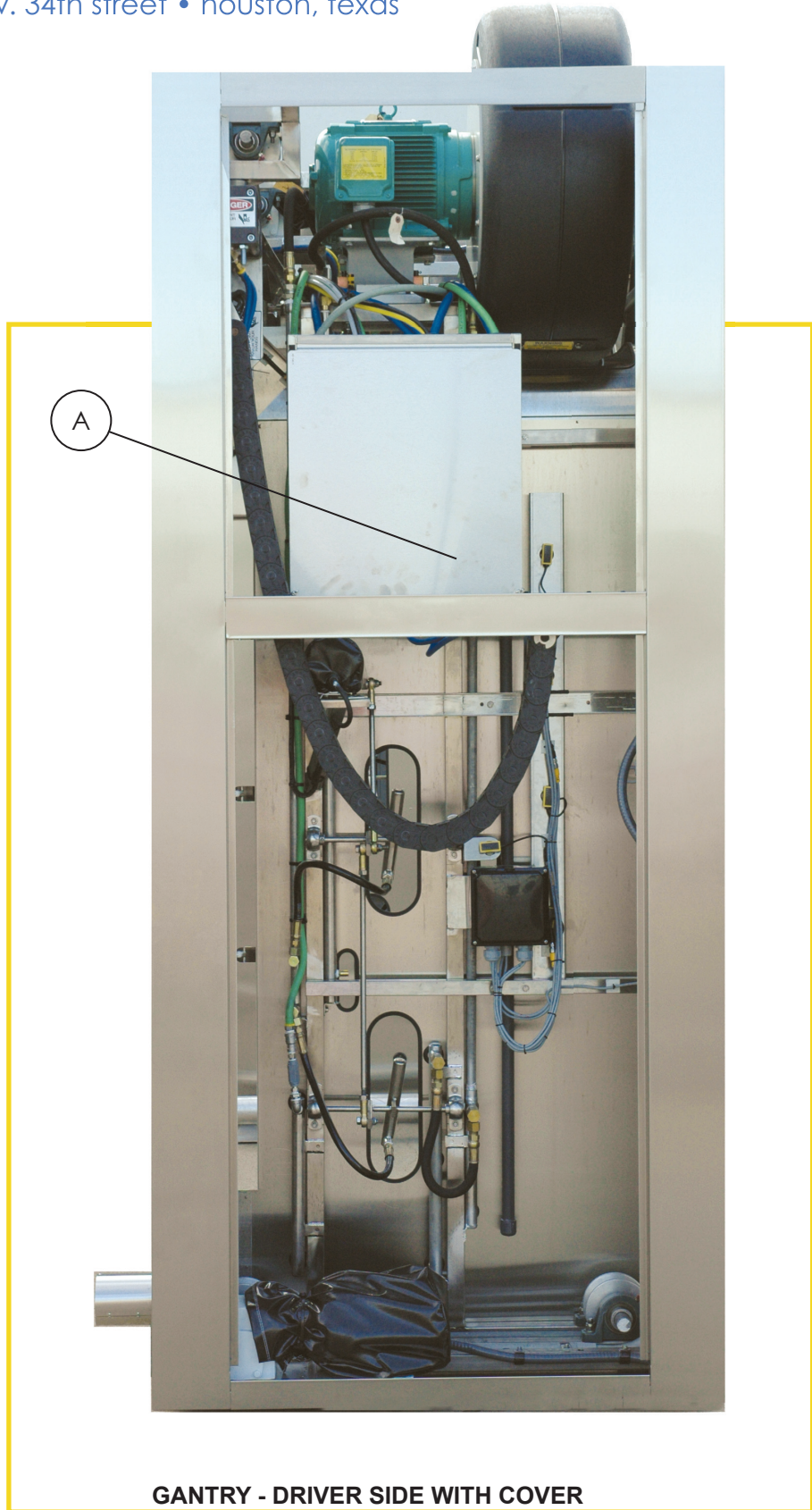

GANTRY - DRIVER SIDE WITH COVER

GANTRY – DRIVER SIDE WITH COVER

A Low Pressure Manifold Box – See page 54

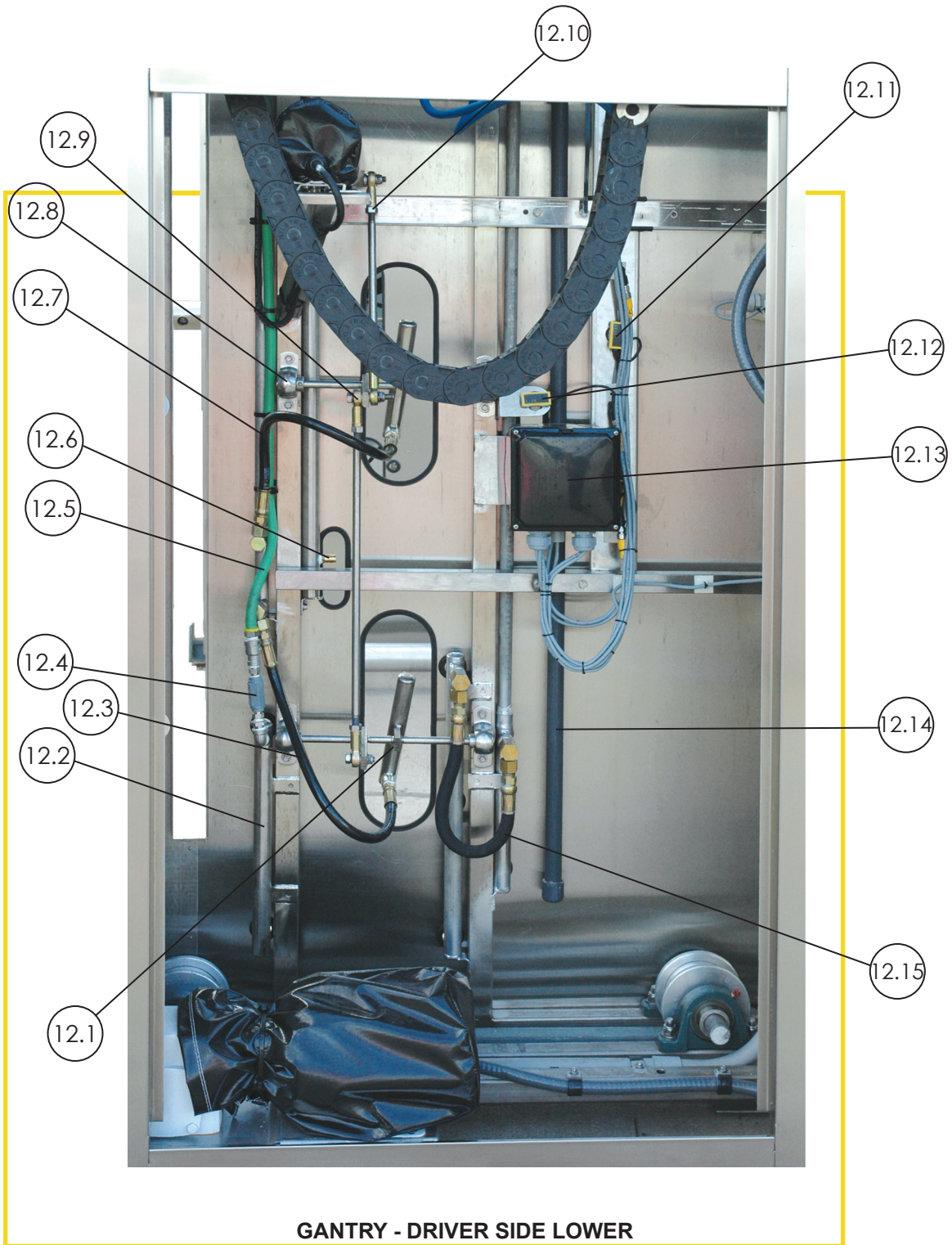

GANTRY – DRIVER SIDE LOWER

ID#	PART#	DESCRIPTION
12.1	6500-OJC-SBD	Oscillator Spray Bar – Side Bottom
12.2	6616	Tire Cleaner Spray Manifold (6500 TCP)
12.3	52010	Synflex 3/8" X 19" Hose
12.4	34025	Check Valve Poly 1/4"
12.5	52012-2	Push Lock Hose – 3/8" Green
12.6	6563	Spray Nozzle – 120 Degree Spot Free Rinse
12.7	52011	Synflex 3/8" X 24" Hose
12.8	6647	Pillow Block Bearing - Oscillator
12.9	6838	Rod End – 7/16"
12.10	6838	Rod End – 7/16"
12.11	6742	Transmitter Eye - Contouring
12.12	6742	Transmitter Eye - Measurement
12.13	6693-D	Eye Frequency Box, Drivers's Side
12.14	22010	Tri-Foam PVC Pipe 3/4"
12.15	52017	1/2" Wire Braided Hose – 18"

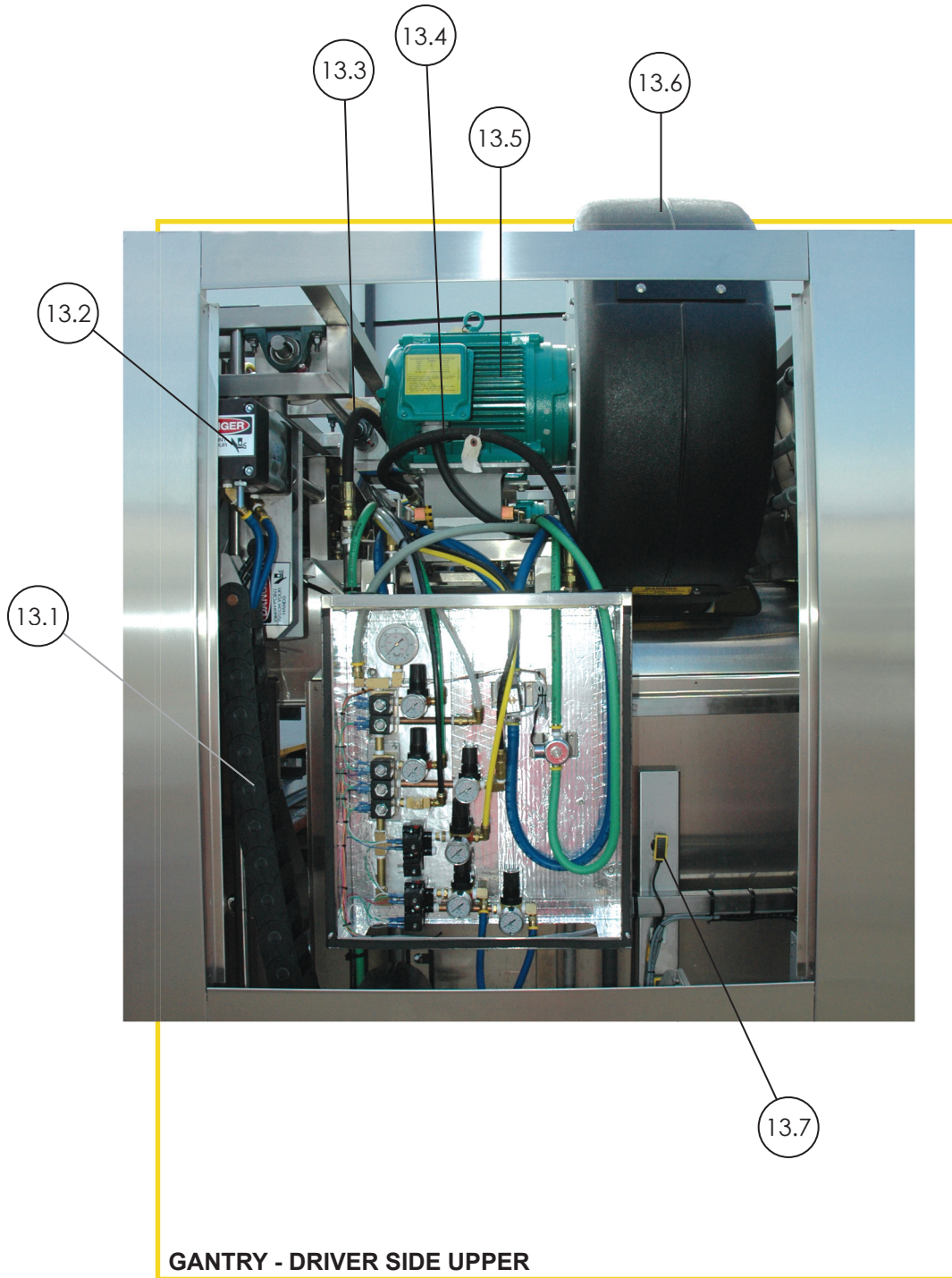

GANTRY – DRIVER SIDE UPPER

ID#	PART#	DESCRIPTION
13.1	6767	Hose Track
13.2	6857	Rotary Actuator – Boom Tilt
13.3	52017	1/2" Wire Braided Hose
13.4	52017	1/2" Wire Braided Hose
13.5	55260	10hp 3ph Blower Motor
13.6	19814	Blower Fan Housing
13.7	6742	Transmitter Eye - Contouring

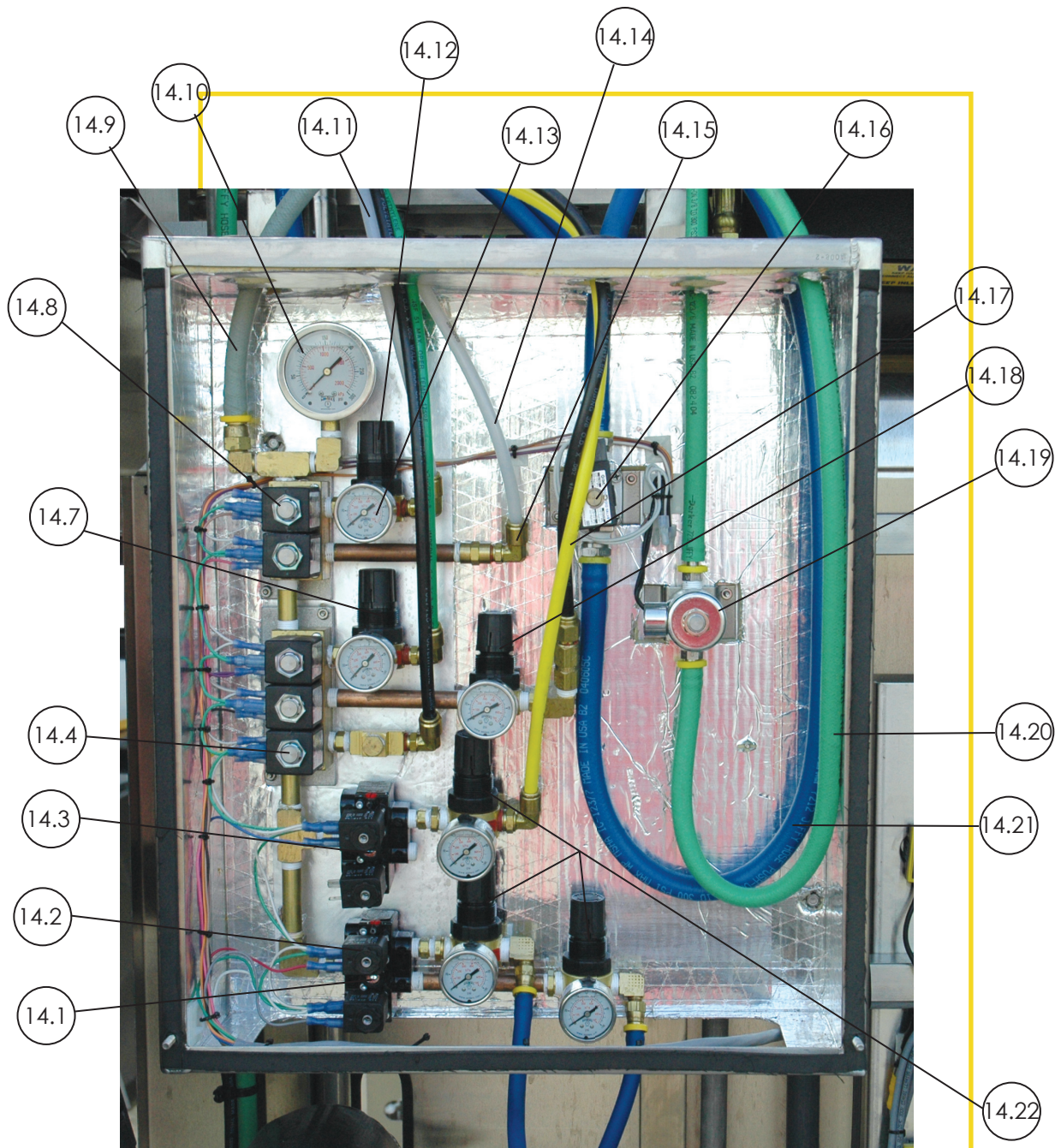

GANTRY - DRIVER SIDE - LOW PRESSURE MANIFOLD

GANTRY – DRIVER SIDE LOW PRESSURE MANIFOLD

ID#	PART#	DESCRIPTION
14.1	64075-1	Air Solenoid – Boom Tilt
14.2	58056	3/8" Regulator – Boom Tilt
14.3	64075-1	Air Solenoid – Presoak Direction
14.4	64021	3 Stage Solenoid
14.7	58055	Air Regulator – Presoak 1/4"
14.8	64021-42	2 Stage Solenoid
14.9	22-801-6-GRA	3/8" Gray Hose
14.10	47011	0-300 Pressure Gauge
14.11	22-E-64-0500	Poly Tubing 3/8" Natural
14.12	58055	Air Regulator – 1/4"
14.13	47027	0-100 Pressure Gauge
14.14	22-E-64-0500	Poly Tubing 3/8" Natural
14.15	22-W169PL-6-4	3/8" X 1/4" Poly Push Lock Swivel – 90 Degree
14.16	6520	Solenoid - Presoak, Hot Wax
14.17	22-E-64-Y-0500	Poly Tubing 3/8" Yellow
14.18	58055	Regulator
14.19	64071	Solenoid Valve – Tire Cleaner
14.20	22-801-6-GRN	3/8" Green Hose
14.21	22-801-8-BLU	1/2" Blue Hose
14.22	58056	Regulator – 3/8"

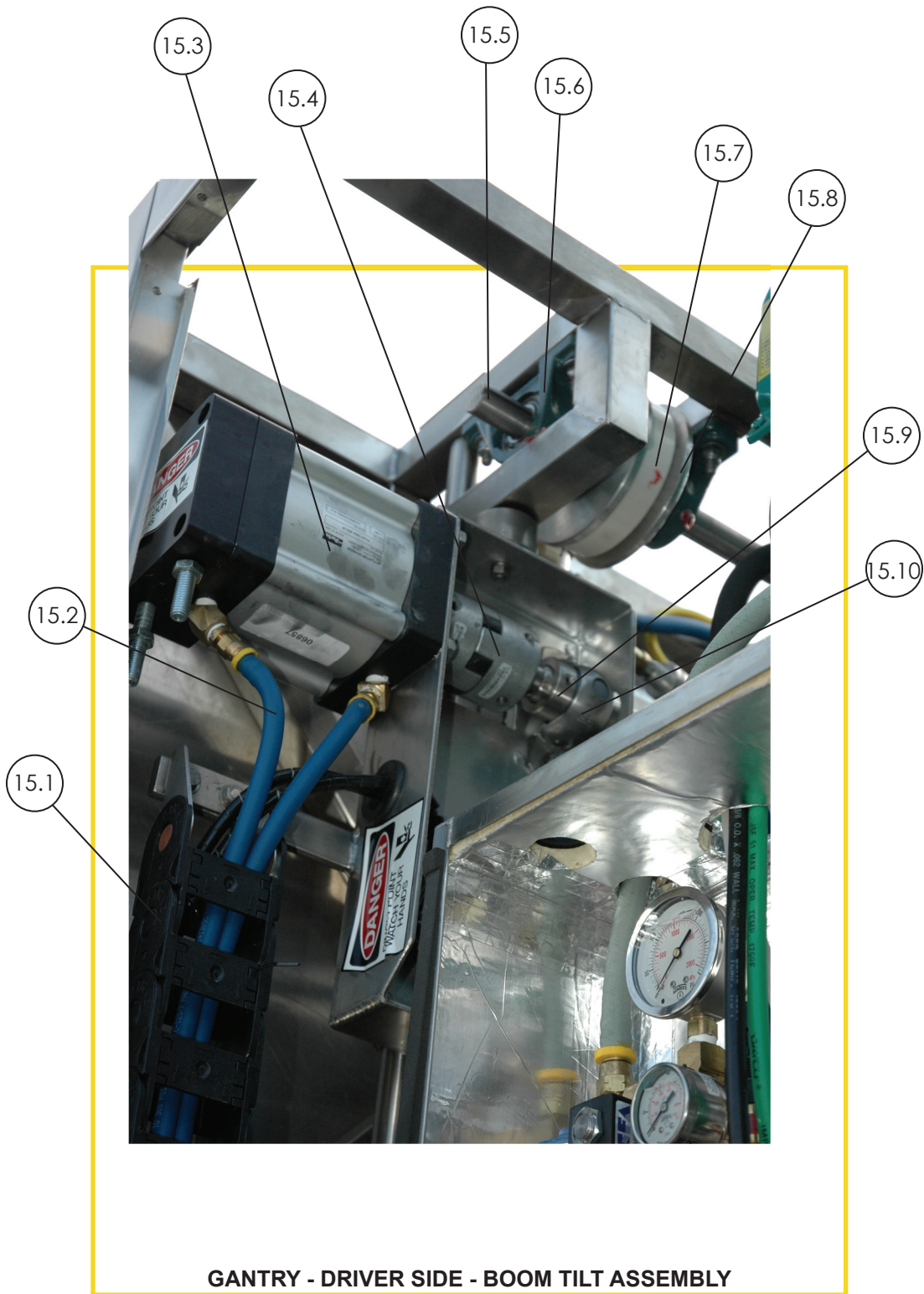

GANTRY – DRIVER SIDE – BOOM TILT ASSEMBLY

ID#	PART#	DESCRIPTION
15.1	6767	Hose Track
15.2	22-801-4-BLU	3/8" Blue Push Lock Hose
15.3	6857	Rotary Actuator
15.4	6800 6803	1" Love Joy Spider
15.5		1" Small Shaft – 31" – Driver's Side
15.6	6850	Pillow Block Bearing – 1"
15.7	6852-8	Kevlar Boom Belt, 8'
15.8	6605	Boom Pulley (AM002)
15.9	6820	Shaft Collar - Boom
15.10	6645-1	Bearing Pillow Block 1 1/8" - Nylon

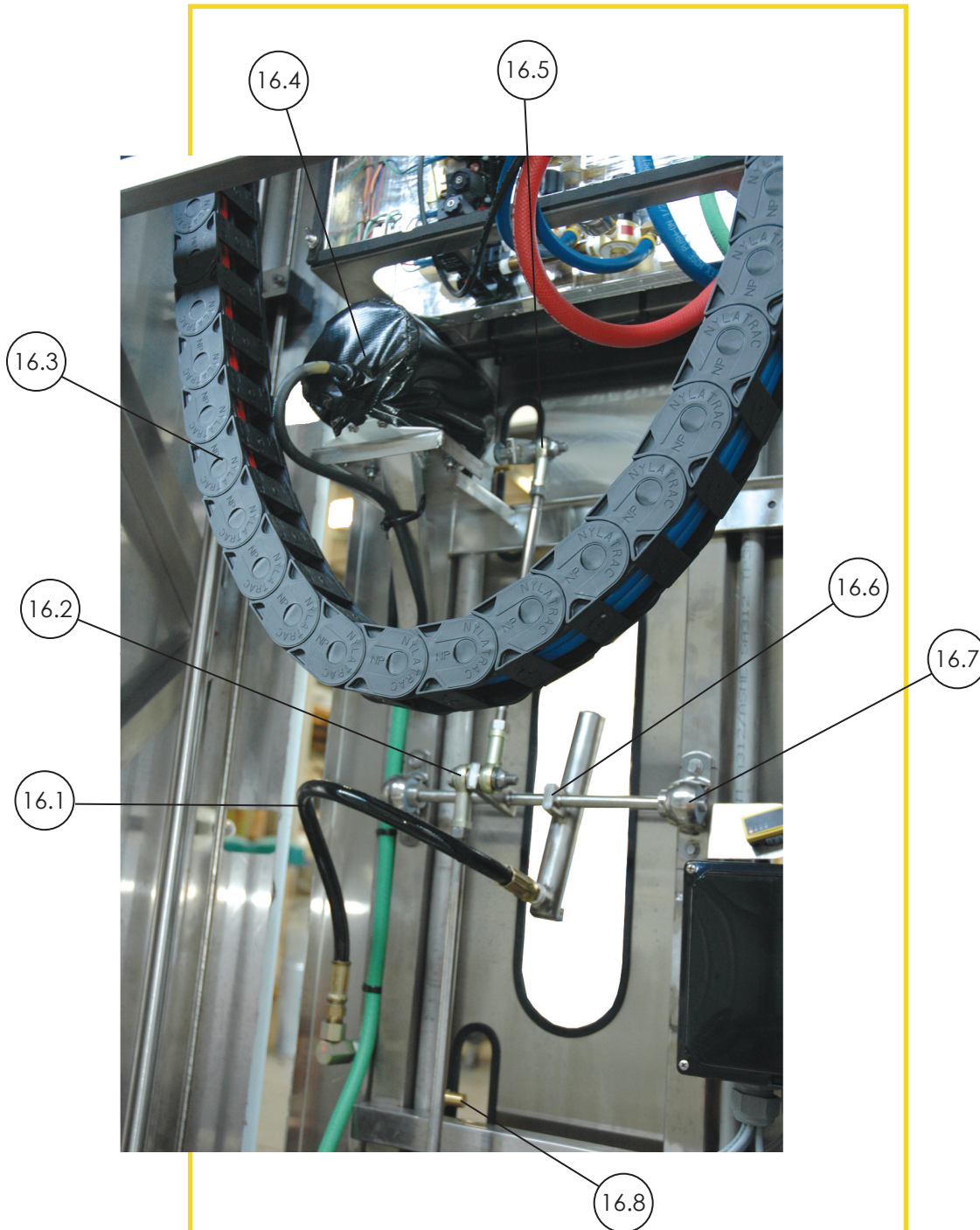

GANTRY - DRIVER SIDE - OSCILLATING ASSEMBLY

GANTRY – DRIVER SIDE – OSCILLATING ASSEMBLY

ID#	PART#	DESCRIPTION
16.1	52011	Synflex 3/8" X 24" Hose
16.2	6838	Rod End - 7/16"
16.3	6767	Hose Track
16.4	55236-1	Oscillating Motor w/ gear box
16.5	6838	Rod End – 7/16"
16.6	6500-OJC-STD	Oscillating Spray Bar - Upper
16.7	6647	Pillow Block Bearing 1/2" - Nylon
16.8	6563	Nozzle – Spot Free

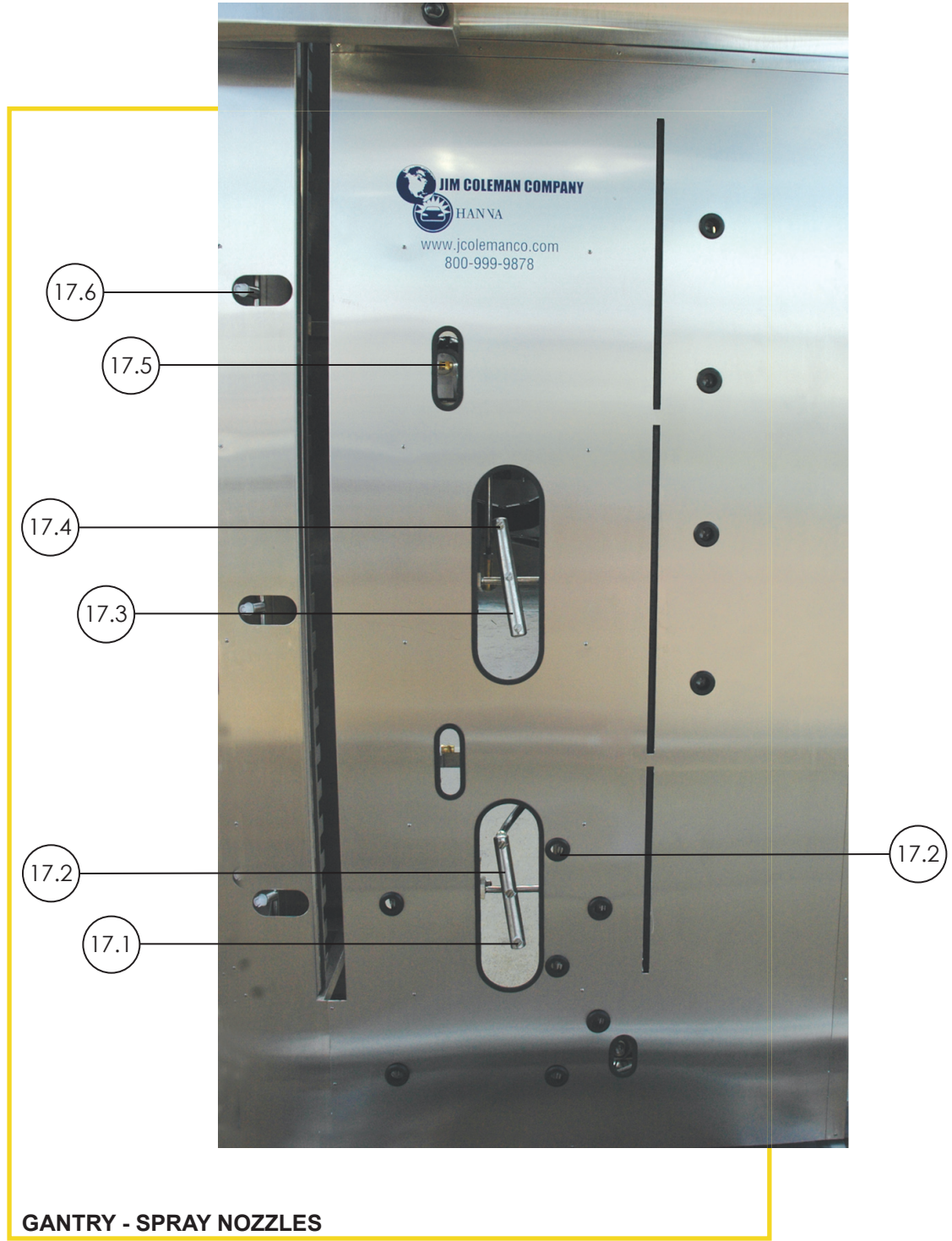

GANTRY - SPRAY NOZZLES

GANTRY – SPRAY NOZZLES

ID#	PARTS#	DESCRIPTION
17.1	84282	Spray Tip 1/4" MEG – 0504
17.2	84282	Spray Tip 1/4" MEG – 0504
17.3	84280	Spray Tip 1/4" MEG – 0503
17.4	84280	Spray Tip 1/4" MEG – 0503
17.5	6563	Spray Nozzle – Spot Free - Side
17.6	6557	Nozzle – Presoak
17.7	82484	Nozzle – Rocker Panel - 1508

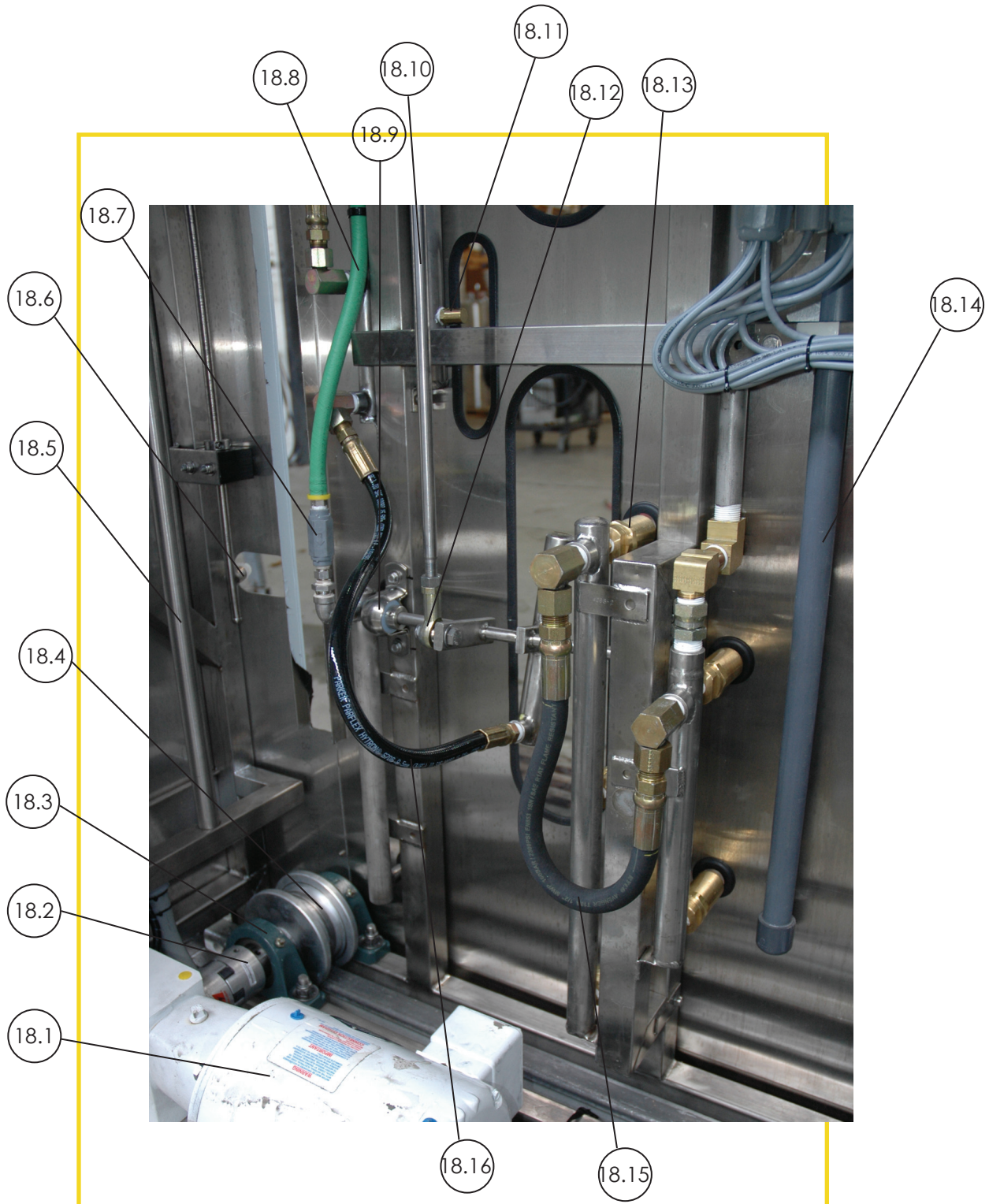

ZERO DEGREE NOZZLE ROCKER PANEL ASSEMBLY

ZERO DEGREE NOZZLE ROCKER PANEL ASSEMBLY

ID#	PART#	DESCRIPTION
18.1	55230-2	Washdown Motor - Drive
18.2	6805	Love Joy – 1 1/4"
	6801	Love Joy – 7/8"
	6803	Spider
18.3	6851	Pillow Block Bearing – 1 1/4"
18.4	6500-W	Drive Wheel
18.5	6500-95"	Shaft Boom Guide
18.6	6559	Spray Nozzle - Presoak
18.7	34025	Check Valve 1/4" Poly FXF
18.8	22-801-6-GRN	3/8" Green Hose
18.9	6647	Pillow Block Bearing
18.10	6500-OR-20	Adjustable Oscillating Rod
18.11	6563	Spray Nozzle - Spot Free Rinse
18.12	6838	Rod End - 7/16
18.13	6551	Zero Degree Nozzle (body)
	6552	Zero Degree Nozzle (insert)
18.14	22010	Tri-Foam PVC 3/4" Pipe
18.15	52017	1/2" Wire Braided Hose
18.16	52010	Synflex 3/8" X 19" Hose

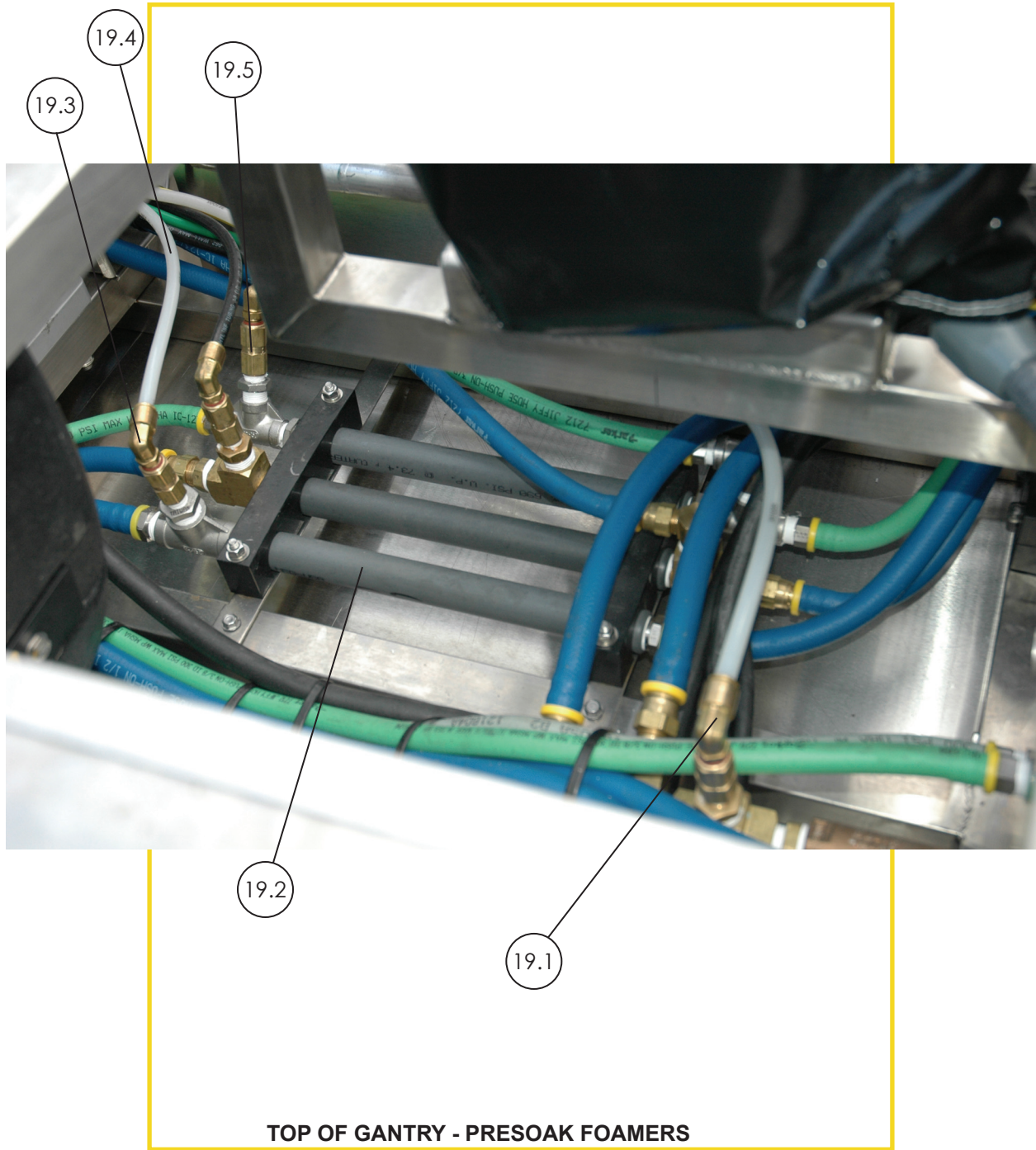

TOP OF GANTRY – PRESOAK FOAMERS

ID#	PART#	DESCRIPTION
19.1	22-169P-6-4	3/8" Poly Tite X 1/4" Male 90
19.2	6500-FG	Foam Generator
19.3	22-169P-6-4	3/8" Poly Tite X 1/4" Male 90
19.4	22-E-64-0500	3/8" Poly Tubing – Natural
19.5	34018	Check Valve, 1/4" Brass FXF

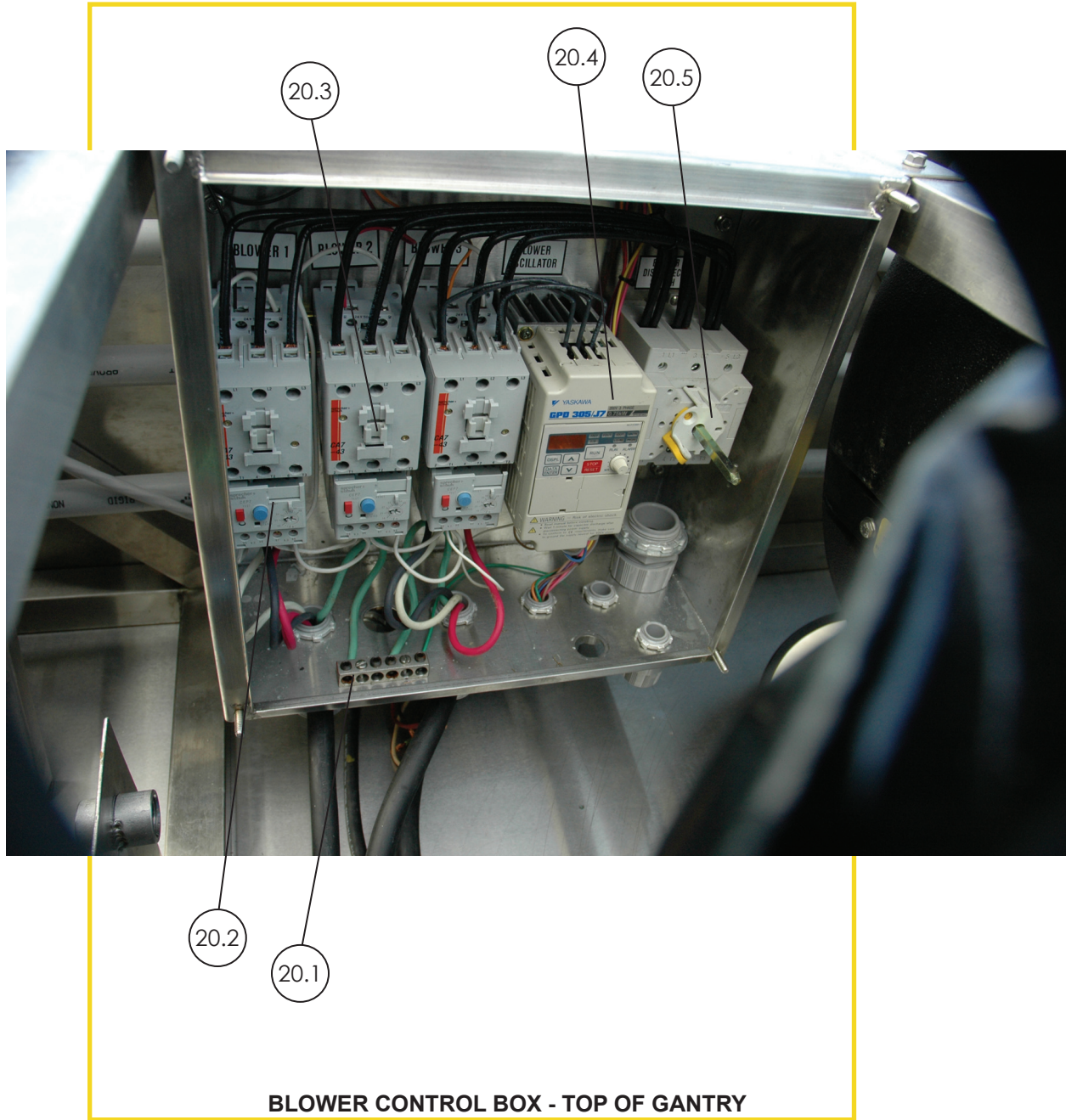

BLOWER CONTROL BOX – TOP OF GANTRY

ID#	PART#	DESCRIPTION
20.1	40446-2	SS. Grounding Bar, 6 PT.
20.2	60064-1	Overload 9-45 amps
20.3	60058	Contactora 43 amp
20.4	6973	Omron Yaskawa Drive
20.5	6994	100 amp Main Disconnect Base Mount

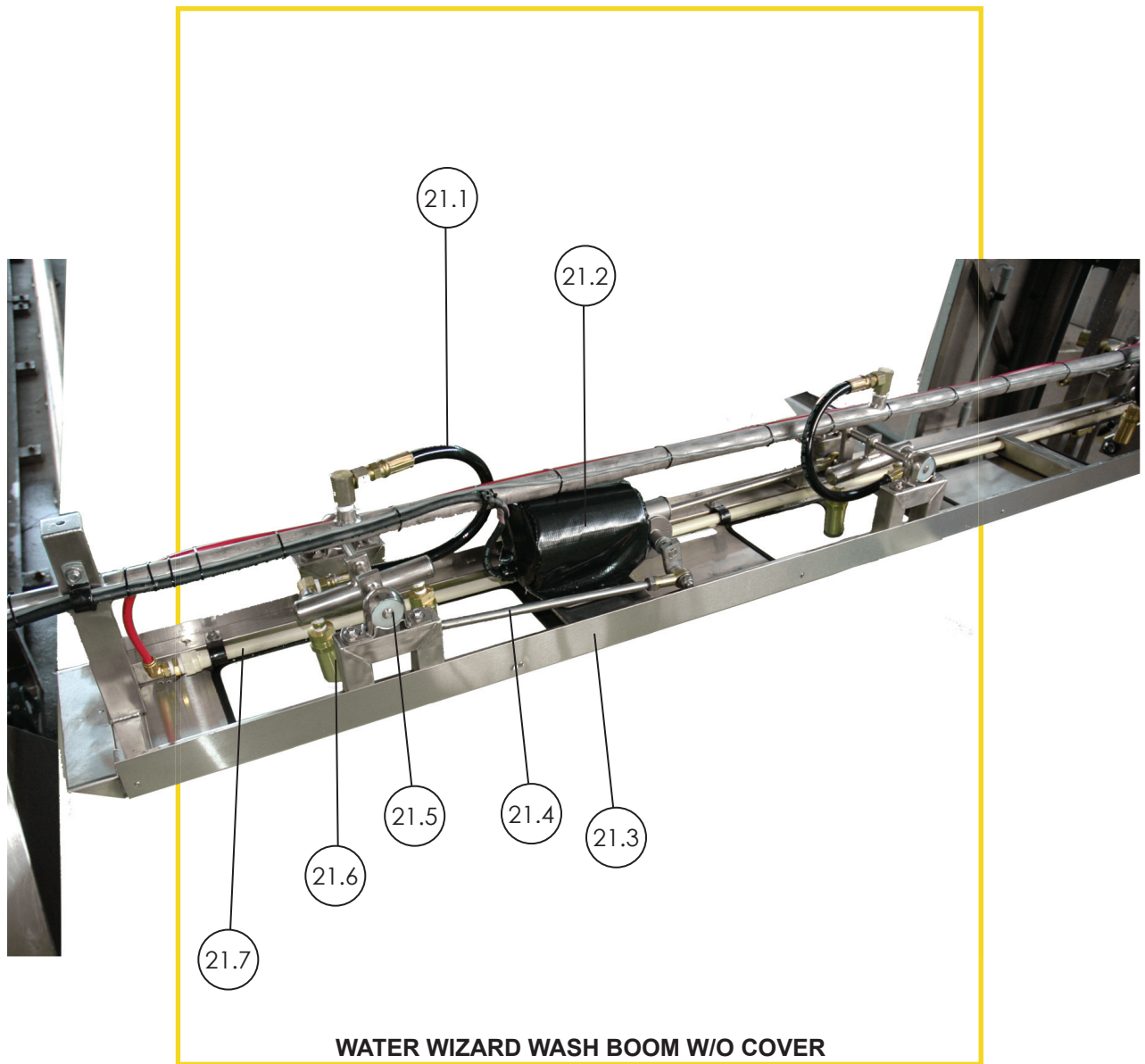

WATER WIZARD 2.0 WASH BOOM W/O COVER

ID#	PART#	DESCRIPTION
21.1	52010	Synflex 3/8" X 19" Hose
21.2	55236-1	Oscillating Boom Motor
21.3	6679	Wash Boom Frame Only
21.4		Linkage 7/16" NF 13.75"
21.5	6647	Pillow Block Bearing - Nylon
21.6	6551 6552	Zero Degree Nozzle (body) Zero Degree Nozzle (insert)
21.7		Low Pressure Hot Wax PVC

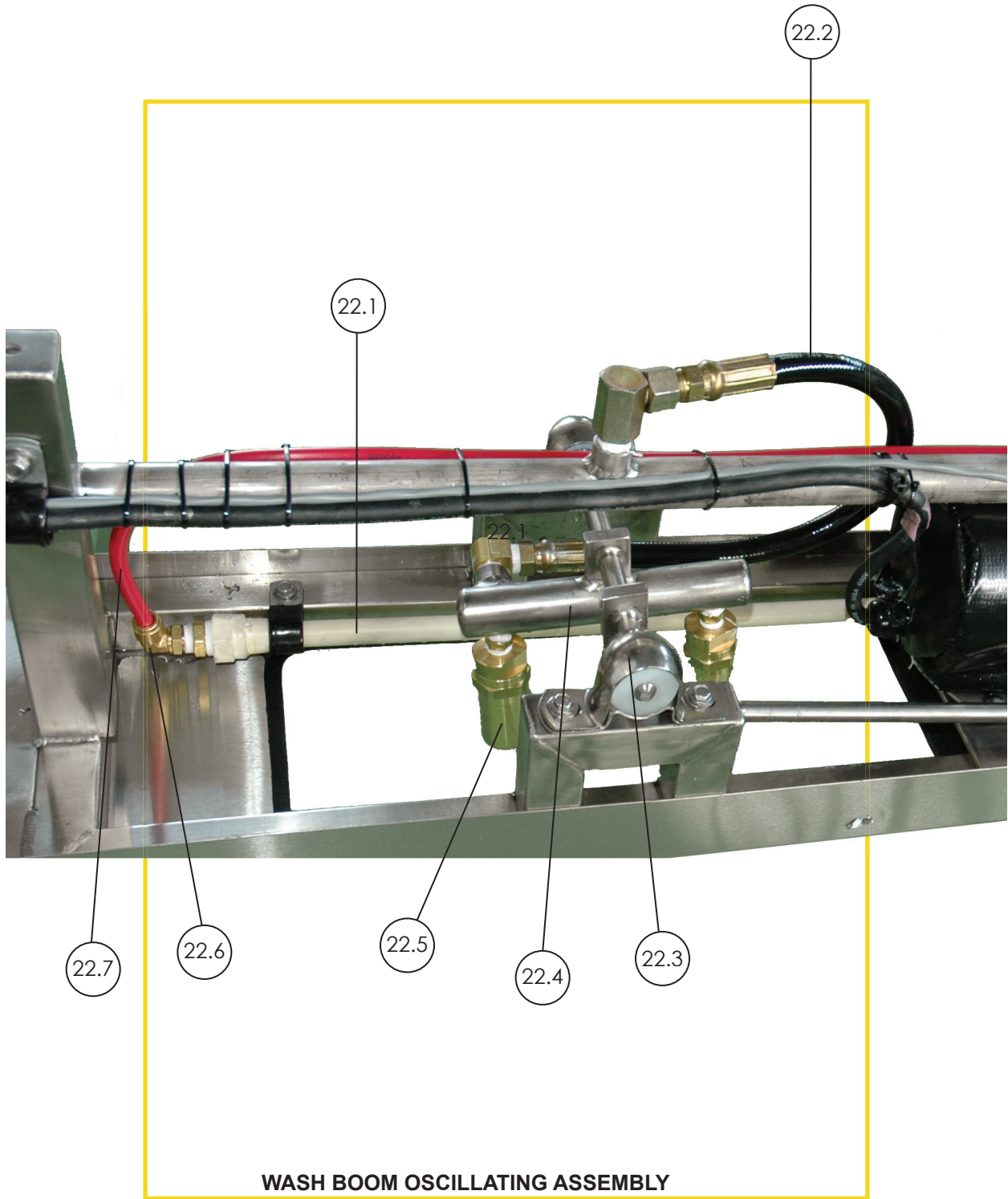

WASH BOOM OSCILLATING ASSEMBLY

WASH BOOM OSCILLATING ASSEMBLY

ID#	PART#	DESCRIPTION
22.1		Low Pressure Hot Wax PVC
22.2	52010	Synflex 3/8" X 19" Hose
22.3	6647	Pillow Block Bearing - Nylon
22.4	6500-OJC-BP	Oscillator Spray Bar – Boom
22.5	6551 6553	Zero Degree Nozzle (body) Zero Degree Nozzle (insert)
22.6	22-2107-6-6	3/8" M X 3/8" F SW 90 Deg.
22.7	22-E-43-R-0500	3/8" Red Poly Tubing

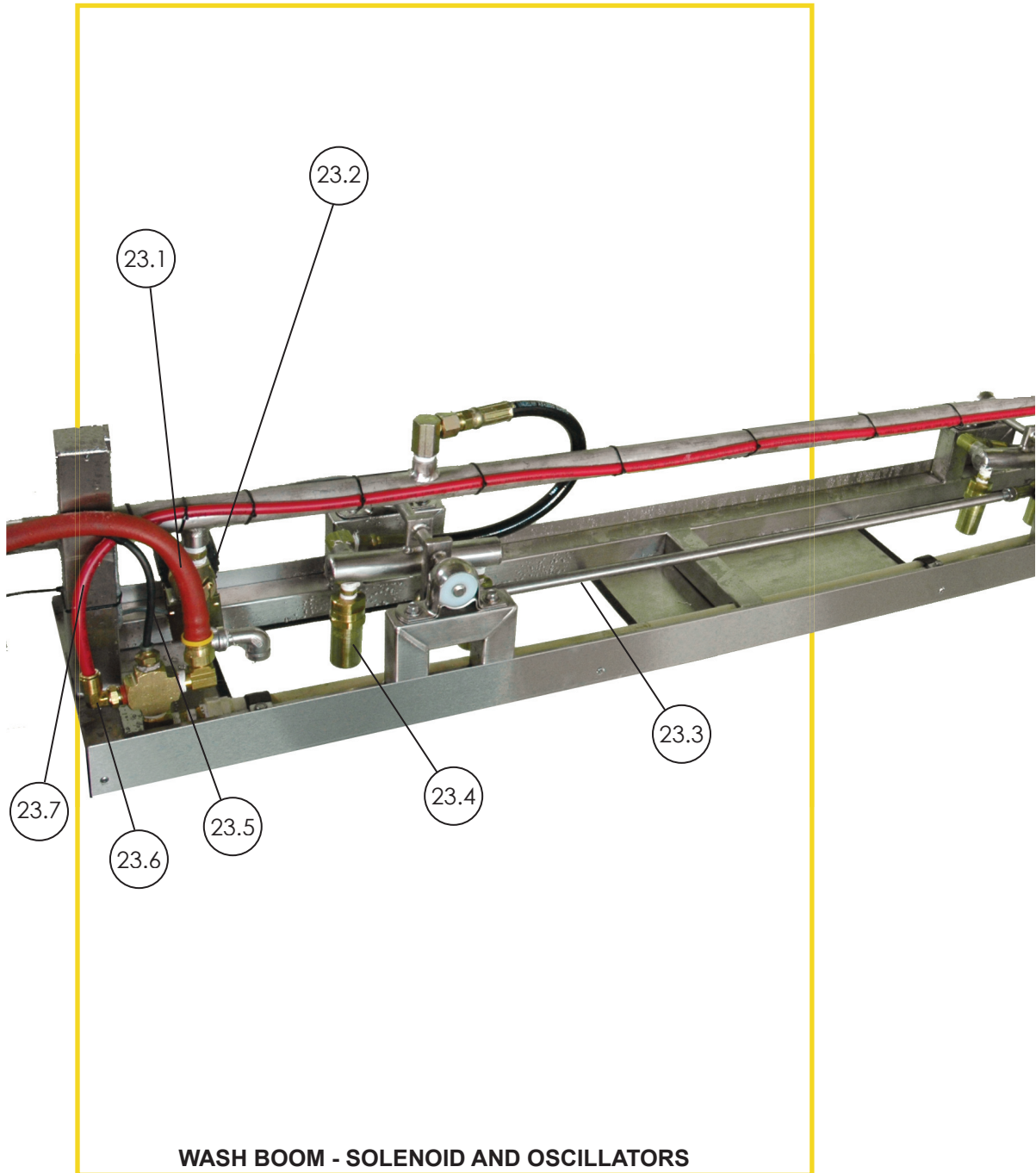

WASH BOOM – SOLENOID AND OSCILLATORS

ID#	PART#	DESCRIPTION
23.1	22-801-8-RED	1/2" Red Hose
23.2	31020	Dema Valve 453P
23.3		Linkage 7/16" 29.50" NFX
23.4	6651 6653	Zero Degree Nozzle (body) Zero Degree Nozzle (insert)
23.5	22-EB-43-0500	Black Poly Tubing 1/4"
23.6	22-2107-6-6	Pipe Swivel-90 3/8"M X 3/8"F
23.7	22-E-64-R-0500	Red Poly Tubing 3/8"

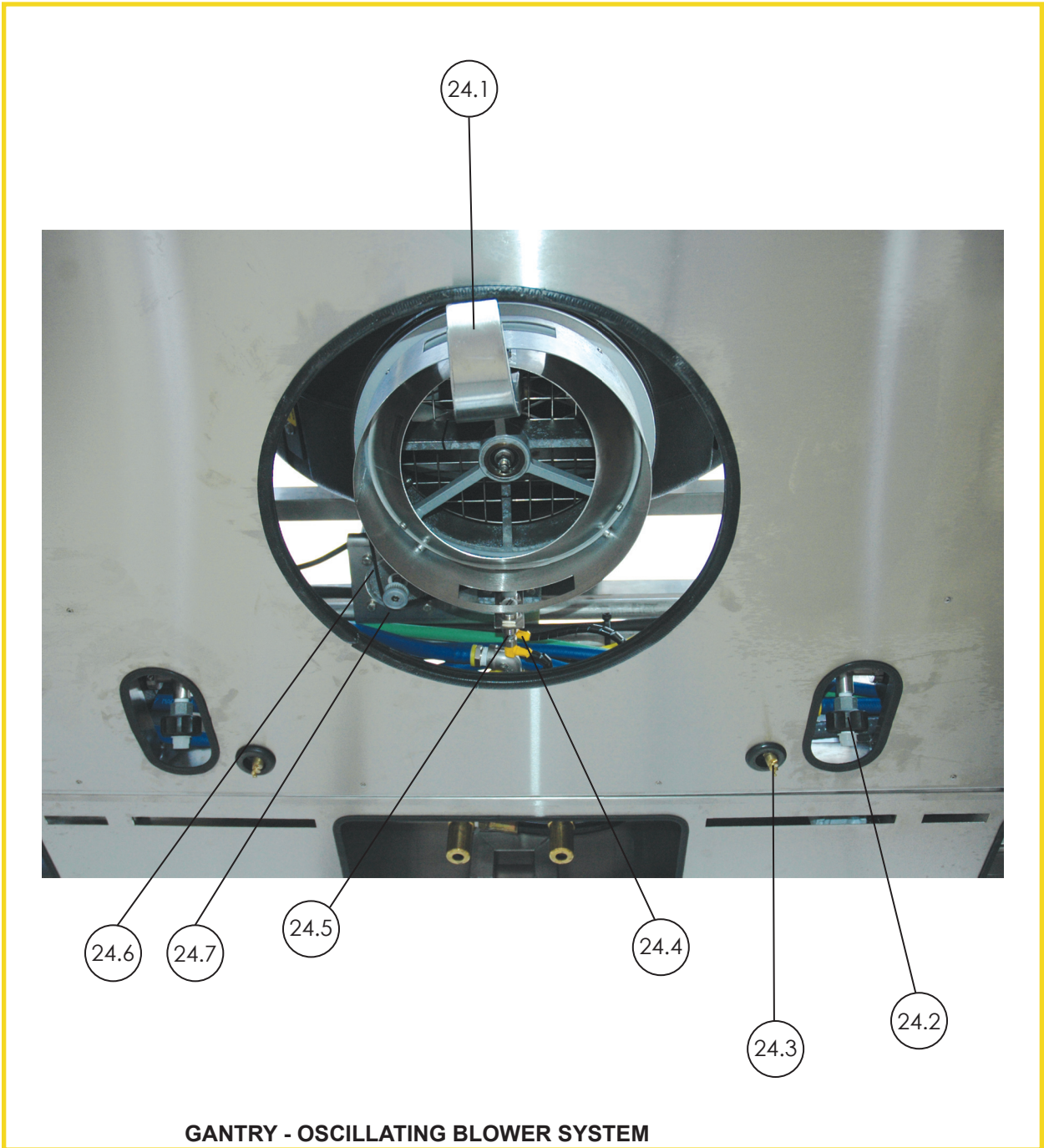

GANTRY - OSCILLATING BLOWER SYSTEM

GANTRY – OSCILLATING BLOWER SYSTEM

ID#	PART#	DESCRIPTION
24.1	19825	Air Scoop
24.2	6561 6562	Tip Assembly - Presoak - Top Boom
24.3	6589	Spot Free Tip - Spiral Cone
24.4	6650-6	Prox Cable
24.5	6626	Prox
24.6	18240	Blower Oscillating Belt
24.7	55239	Blower Oscillating Motor



GANTRY PANEL DOORS (BOTH SIDES)

GANTRY PANEL DOOR (BOTH SIDES)

ID#	PART#	DESCRIPTION
25.1	6670	Access Door – Top (A118)
25.2	6669	Access Door – Bottom (A117)

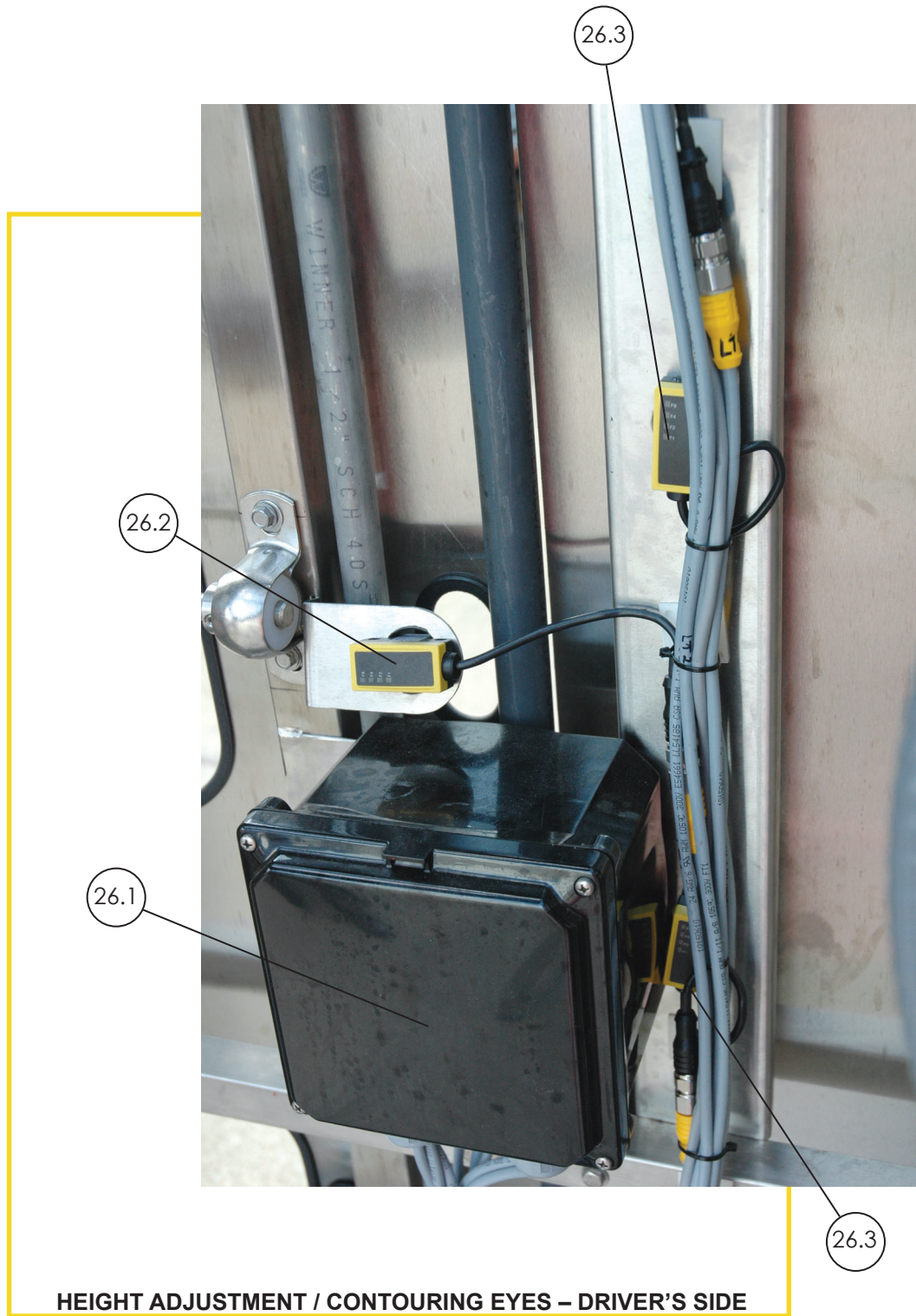

HEIGHT ADJUSTMENT / CONTOURING EYES – DRIVER’S SIDE

ID#	PART#	DESCRIPTION
26.1	6693-D	Eye Frequency Termination Box
26.2	6742	Transmitter Eye - Measurement
26.3	6742	Transmitter Eye - Contouring

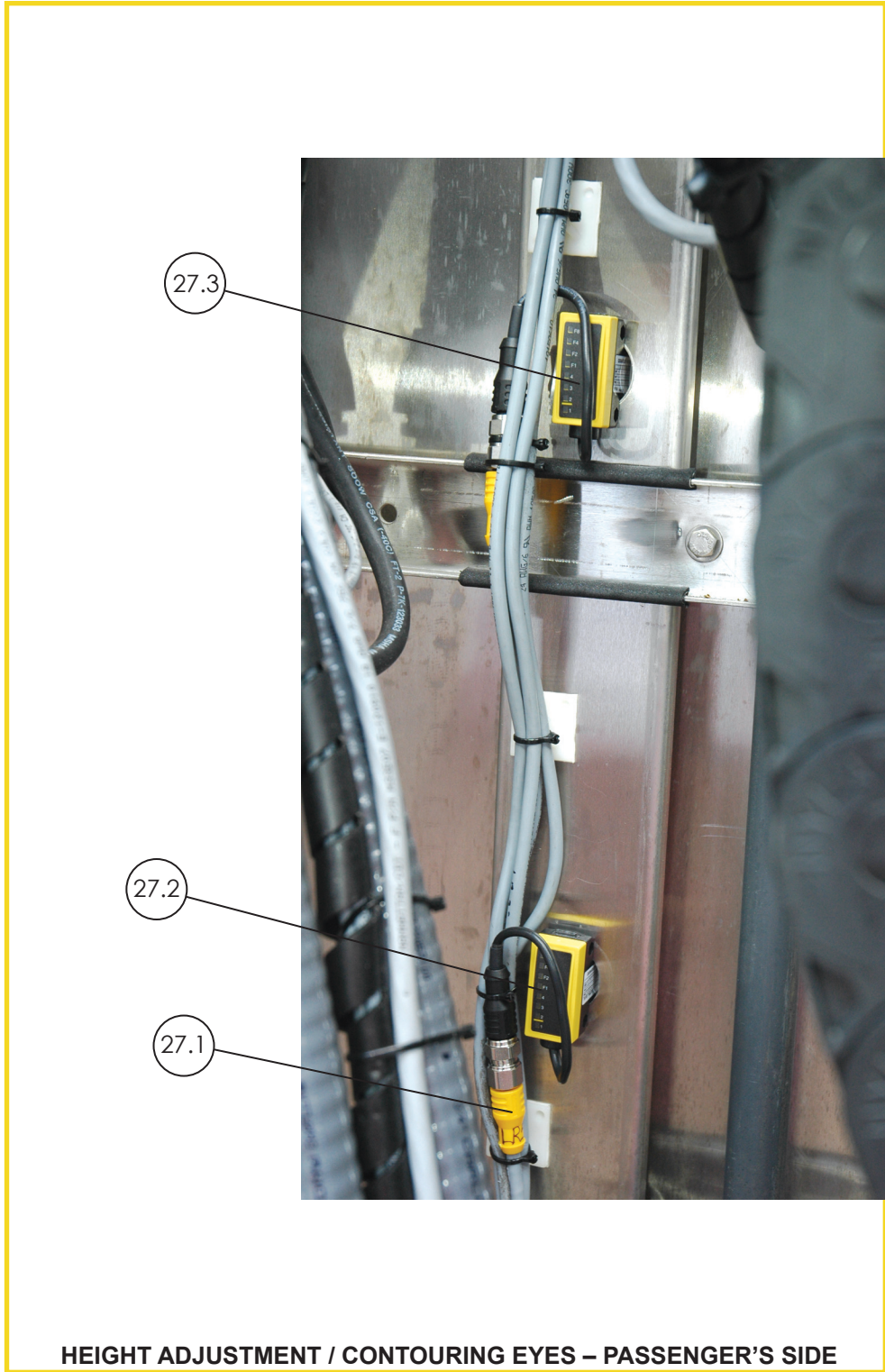

HEIGHT ADJUSTMENT / CONTOURING EYES – PASSENGER’S SIDE

ID#	PART#	DESCRIPTION
27.1	6716	Eye Cable, 2 meter
27.2	6741	Receiver Eye
27.3	6741	Receiver Eye

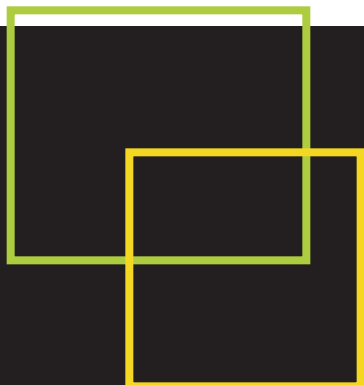

For more information on the Water Wizard 2.0 and other world class car wash equipment and parts manufactured by Jim Coleman Company please contact us at:

1.800.999.9878
5842 W. 34th Street
Houston, Texas 77092
www.jcolemanco.com

Parts Department Direct Line:
1.866.927.4229
Fax: 713.590.6652



parts manual
WATER WIZARD 2.0



• 1.800.999.9878
5842 w. 34th street
houston, tx 77092

www.jcolemanco.com

parts department
1.866.927.4229
713.590.6652.fax