

2007 FUSION X PARTS MANUAL

TABLE OF CONTENTS

Page

GANTRY

05

Gantry – Side Brush Carriage – Right Side	10
Gantry – Side Brush Carriage – Left Side	12
Gantry – Driver’s Side	14
Gantry – Driver’s Side – Front View	16
Gantry – Upper – Driver’s Side	18
Gantry – Passenger’s Side – Exit End View	20
Gantry – Passenger’s Side – Front View	22
Gantry – Upper – Passenger’s Side	24
Gantry – Wheel Brush Assembly	26
Gantry – Wheel Brush Assembly	28
Gantry – Electrical Panel	30
Gantry – Electrical Panel – Upper	32
Gantry – Electrical Panel – Lower	34
Gantry – Sparklesoft	36

PUMPSTAND

40

Pumpstand – Low Pressure Pumps	44
Pumpstand – Back	46
Pumpstand – Pump End	48
Pumpstand – Motor End	50
Pumpstand – Control Panel	52
Pumpstand – Electrical Control Center	54
Pumpstand – ECC – Upper	56
Pumpstand – ECC – I/O Cards	58
Pumpstand – ECC – CPU	60

gantry





GANTRY ENTRANCE - WITH SKINS



GANTRY EXIT - WITH SKINS

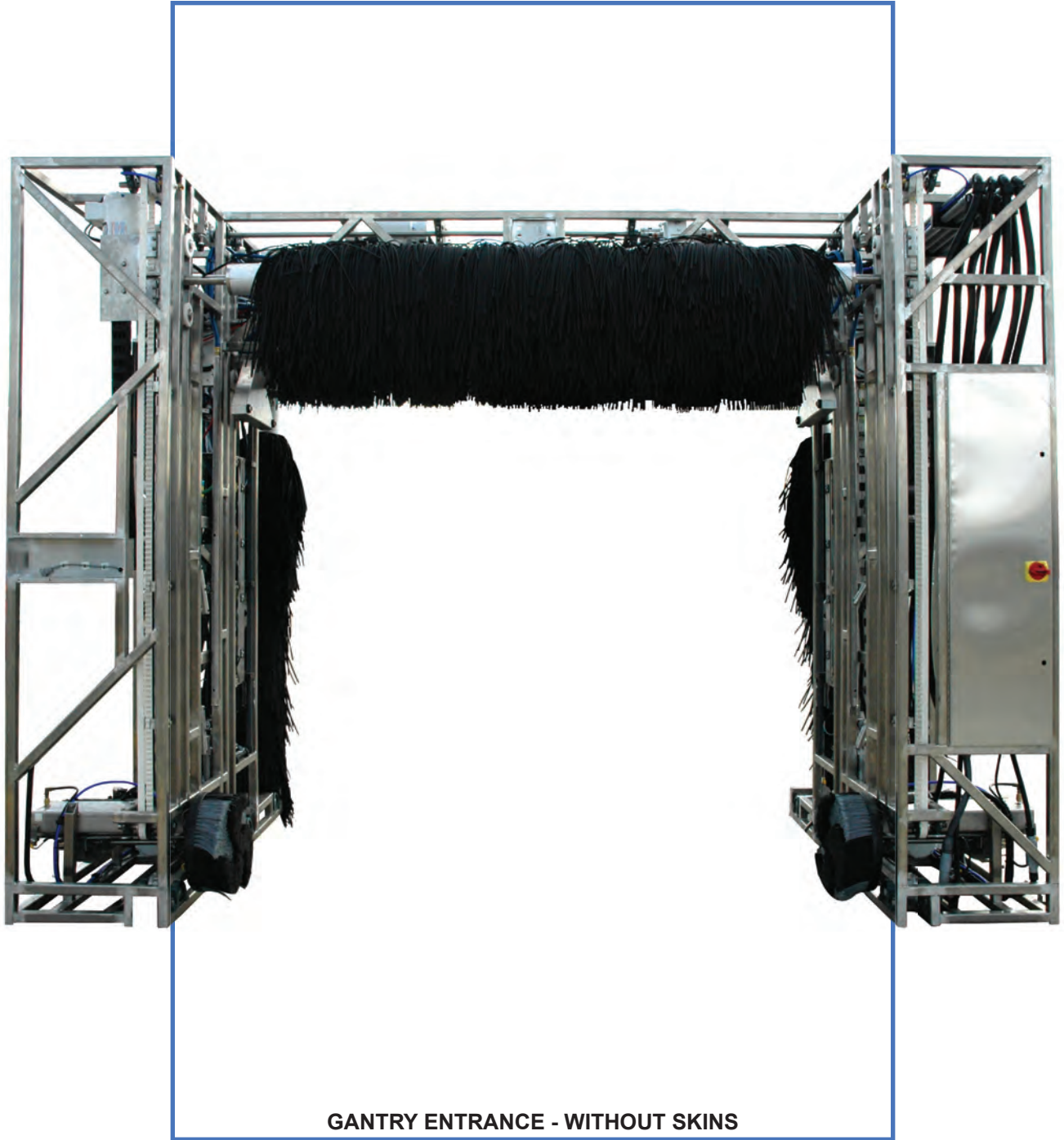

GANTRY ENTRANCE - WITHOUT SKINS



GANTRY EXIT - WITHOUT SKINS

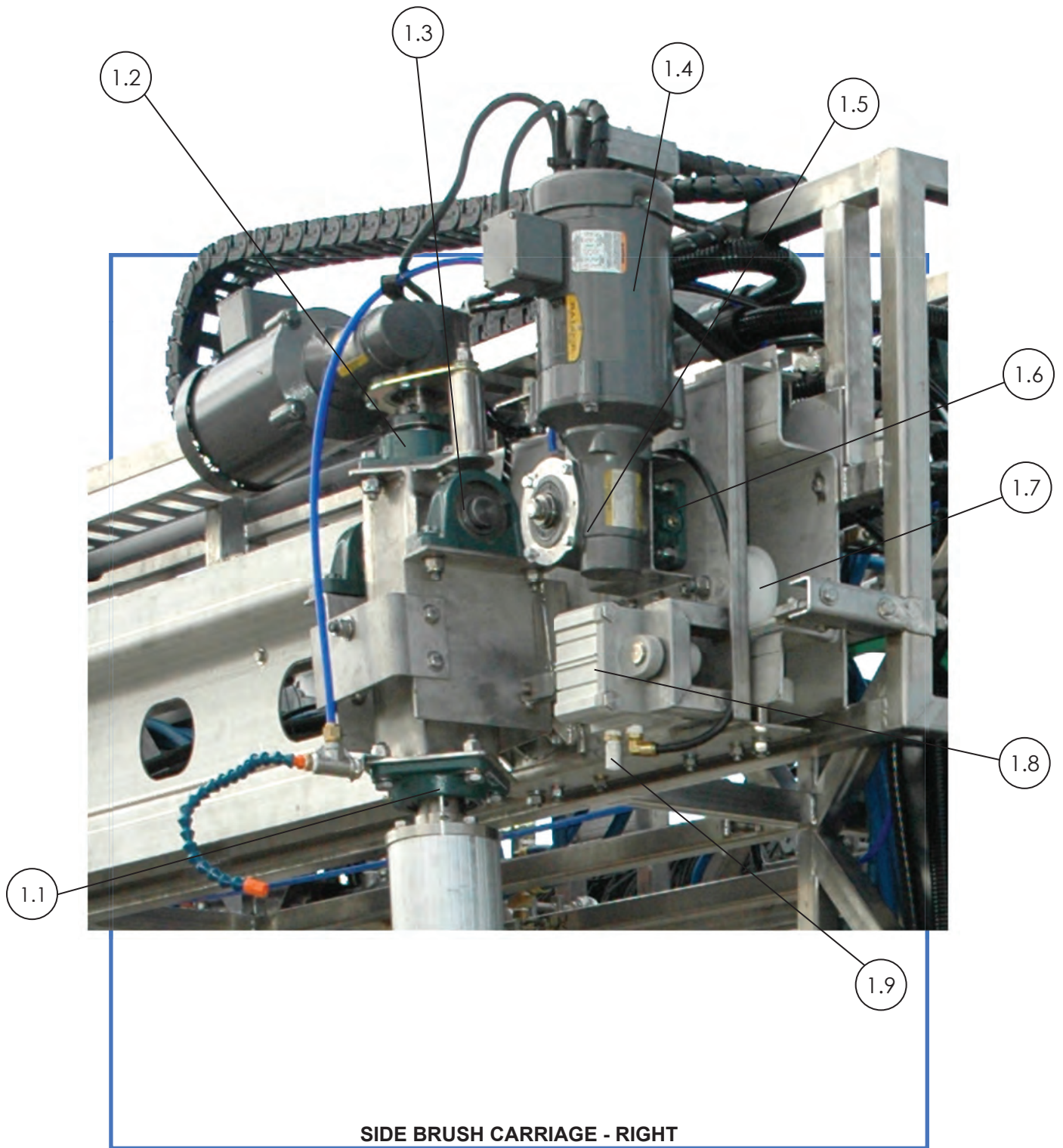

SIDE BRUSH CARRIAGE - RIGHT

GANTRY – SIDE BRUSH CARRIAGE – RIGHT SIDE

ID#	PART#	DESCRIPTION
1.1	07513	Bearing, Flange 1.5" 4 Bolt
1.2	07514	Bearing, Flange Roller 1.5"
1.3	06851	Pillow Block-Vps-120
1.4	55001	Gear Motor, 10:1 Washdown Hs
1.5	55001	Gear Motor, 10:1 Washdown Hs
1.6	07511	Bearing, Flange 1" 4 Bolt
1.7	MS-AC52	Belt Idler Pulley
1.8	07501	Air Cyl, 100Mm Bore X 25Mm Strncq2D10025Dxc6
1.9	07502	Muffler, Pneumatic

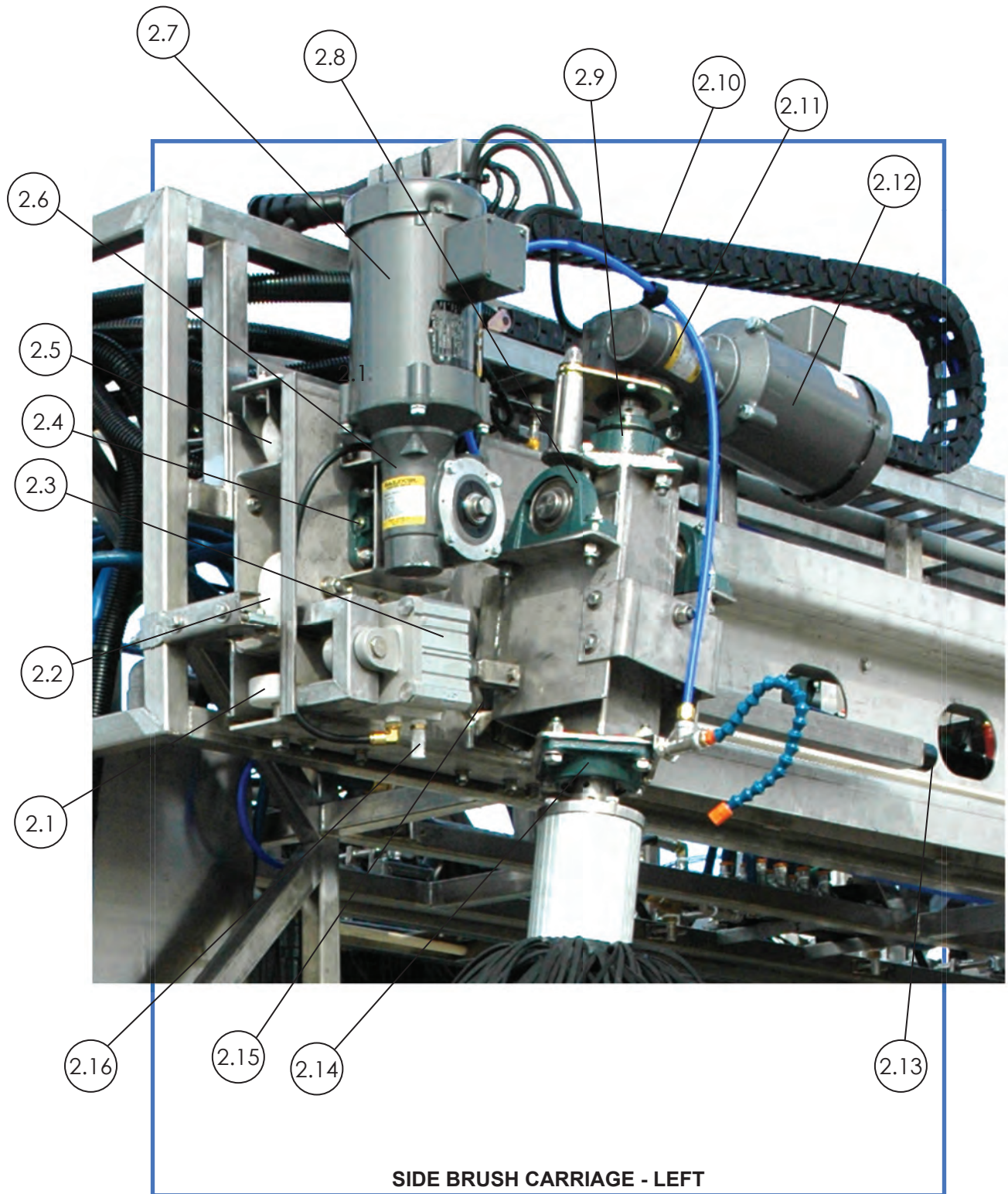

GANTRY – SIDE BRUSH – CARRIAGE – LEFT SIDE

ID#	PART#	DESCRIPTION
2.1	MS - AC51	Side Brush Carriage Rollers
2.2	MS - AC52	Belt Idler Pulley
2.3	07501	Air Cyl, 100Mm Bore X 25Mm
2.4	07511	Bearing, Flange 1" 4 Bolt
2.5	MS - AC51	Side Brush Carriage Rollers
2.6	55001	Gear Motor, 10:1 Washdown Hs
2.7	55001	Gear Motor, 10:1 Washdown Hs
2.8	06851	Pillow Block-Vps-120
2.9	07514	Bearing, Flange Roller 1.5"
2.10	07515	Cable Carrier, 2.25"X1.03"X8'
2.11	55001	Gear Motor, 10:1 Washdown Hs
2.12	55001	Gear Motor, 10:1 Washdown Hs
2.13	07528	Rubber Stopper
2.14	07513	Bearing, Flange 1.5" 4 Bolt
2.15	07528	Rubber Stopper
2.16	07502	Muffler, Pneumatic

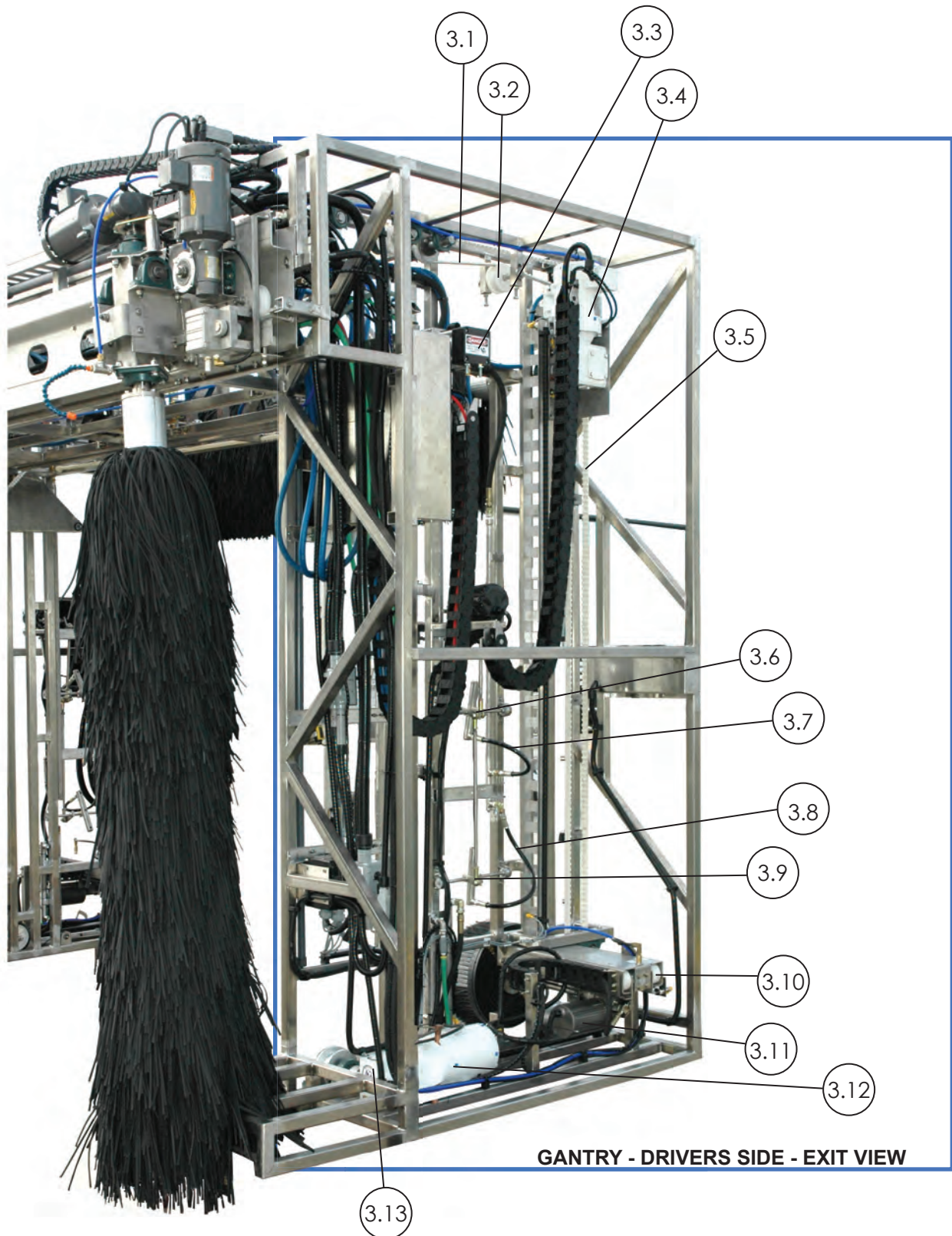

GANTRY - DRIVERS SIDE - EXIT VIEW

GANTRY – DRIVERS SIDE

ID#	PART#	DESCRIPTION
3.1	18013	Belt, Timing Ss Endless
3.2	MS-AC52	Belt Idler Pulley
3.3	06857	Rotary Actuator
3.4	55230-2	.5Hp, 3/60, Inv Dty, Washdown
3.5	18012	Belt, Timing Kevlar 50,000Mm
3.6	06838	Rod End-7/16"
3.7	22-00006	Hose, 3/8" Plastic X 19", 3/8
3.8	22-00007	Hose, 3/8" Plastic X 24"
3.9	06838	Rod End-7/16"
3.10	MS-AC54	Wheel Brush Side Rollers
3.11	55000	Gear Motor, 1/3Hp 30:1 1" Hs
3.12	55230-2	.5Hp, 3/60, Inv Dty, Washdown
3.13	55225-1	Gear Box Lf-918, 30:1 Washdown

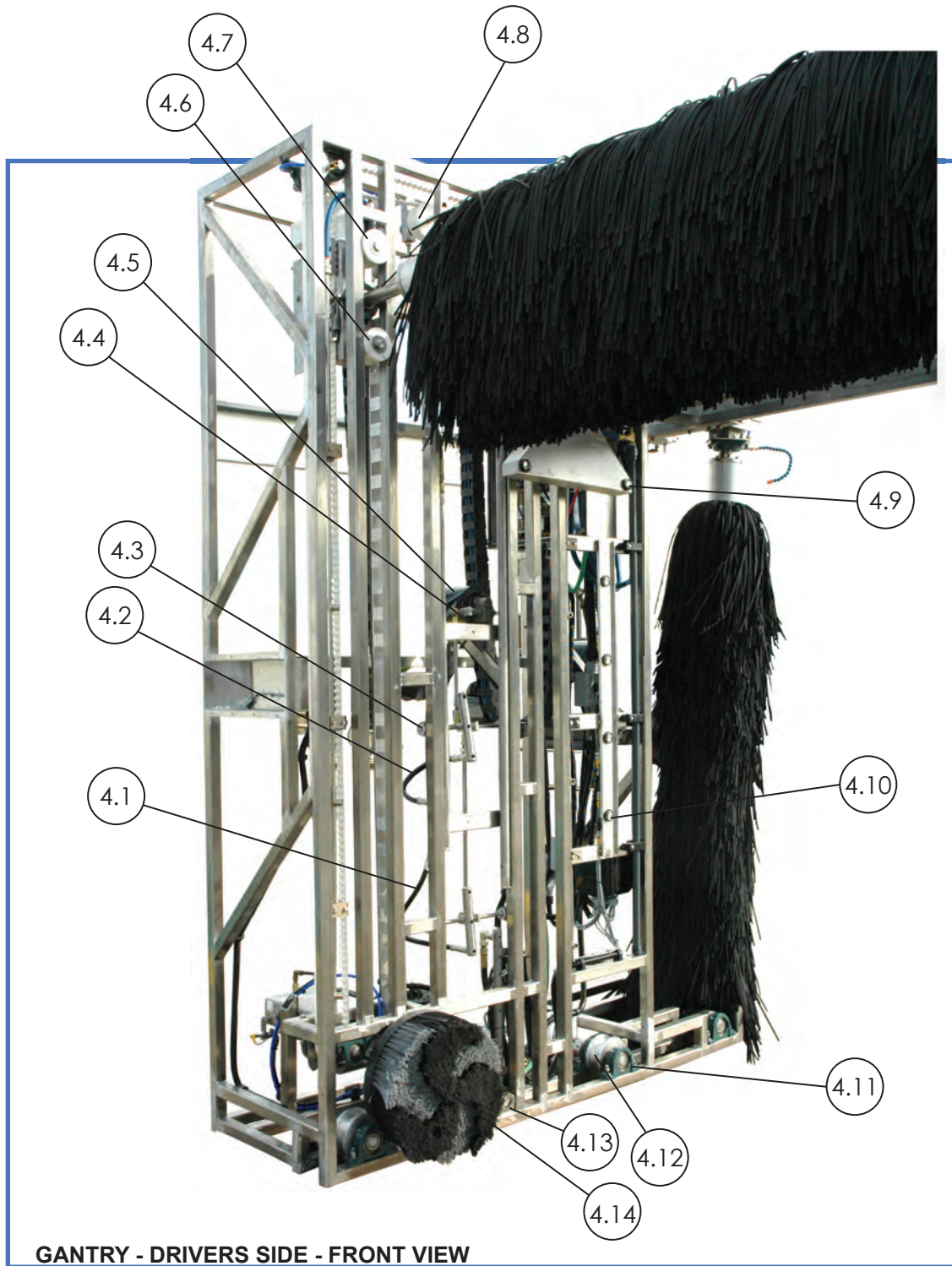

GANTRY – DRIVERS SIDE – FRONT VIEW

ID#	PART#	DESCRIPTION
4.1	22-00007	Hose, 3/8" Plastic X 24"
4.2	22-00006	Hose, 3/8" Plastic X 19"
4.3	06647	Pillow Block Bearing - 1/2"
4.4	06838	Rod End-7/16"
4.5	55236-1	.13 Oscillating Motor W/Gearbx
4.6	MS-AC56	Guide Roller Halves
4.7	MS-AC56	Guide Roller Halves
4.8	MS-AC52	Belt Idler Pulley
4.9	06712	Emitter, 8-Channel
4.10	06712	Emitter, 8-Channel
4.11	06851	Pillow Block-Vps-120
4.12	06500-W	Wheel, Drive
4.13	06712	Emitter, 8-Channel
4.14	07519	Wheel Brush, Silver/Black

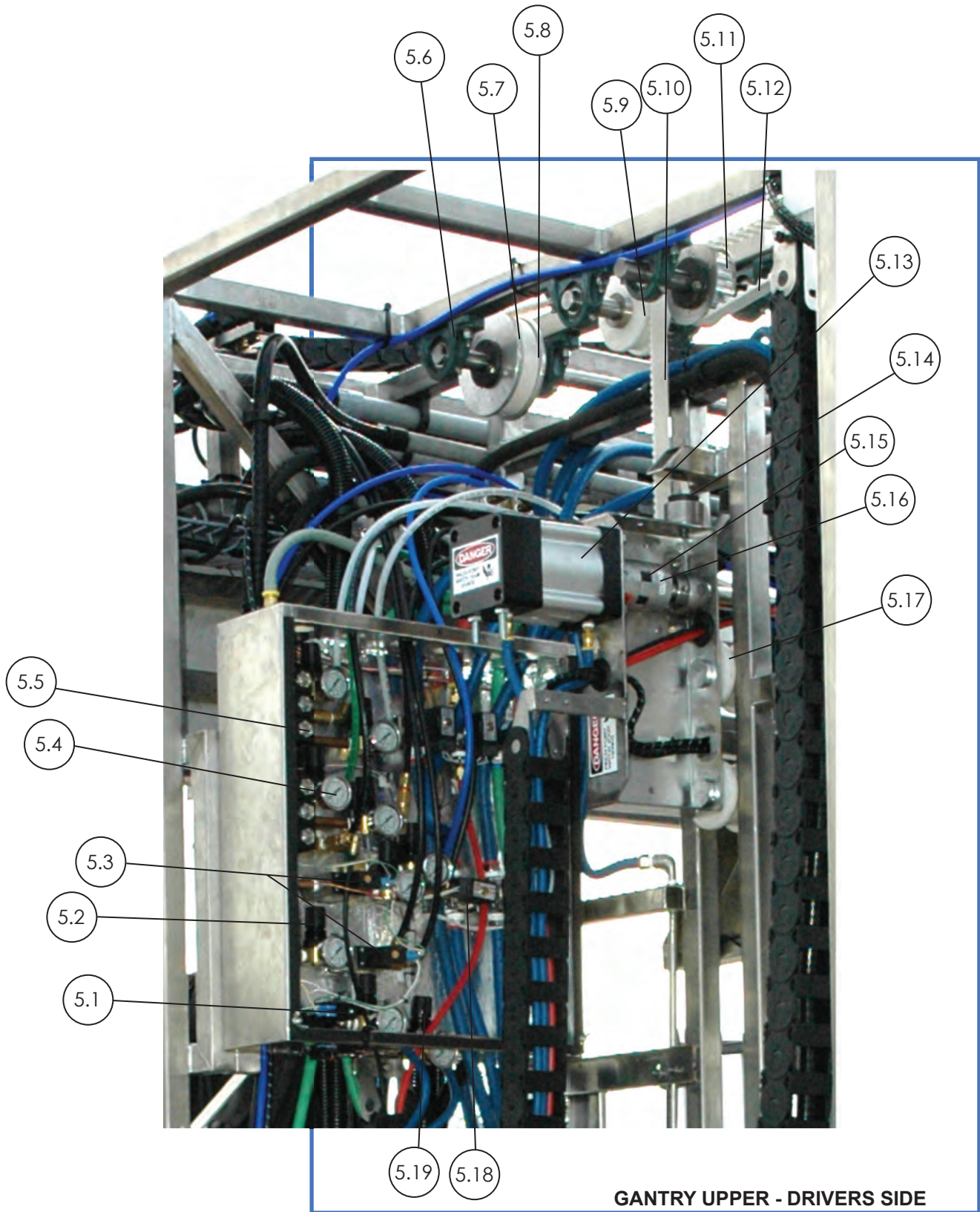

GANTRY UPPER - DRIVERS SIDE

GANTRY UPPER – DRIVERS SIDE

ID#	PART#	DESCRIPTION
5.1	64075-1	Solenoid, Air Auto Dbl Act
5.2	58055	Regulator, Watts 1/4"
5.3	64000	Solenoid, Air 24Vac Coil
5.4	47027	Gauge-Wika 0-100Psi-Automatic
5.5	64021	43211N206-21 3Stage 1/4
5.6	06850	Pillow Blocks-Vps-116
5.7	06605	Pulley, Boom, Alum
5.8	06852	Belt-25At10/50,000-Mk92
5.9	MS-AC53	Belt Idler Pully
5.10	06852	Belt-25At10/50,000-Mk92
5.11	18009	Pulley, Cog 25Mm X 94Mm
5.12	18013	Belt, Timing Ss Endless
5.13	06857	Rotary Actuator
5.14	20053	Boom Stopper-Black Rubber
5.15	06803	Spider 1X406 Black
5.16	06800	Love Joy 1" Coupling
5.17	MS-AC56	Guide Roller Halves
5.18	06520	Solenoid Valve, 1/2", 24Vac
5.19	58056	Regulator, 3/8 Hi-Flow Mini

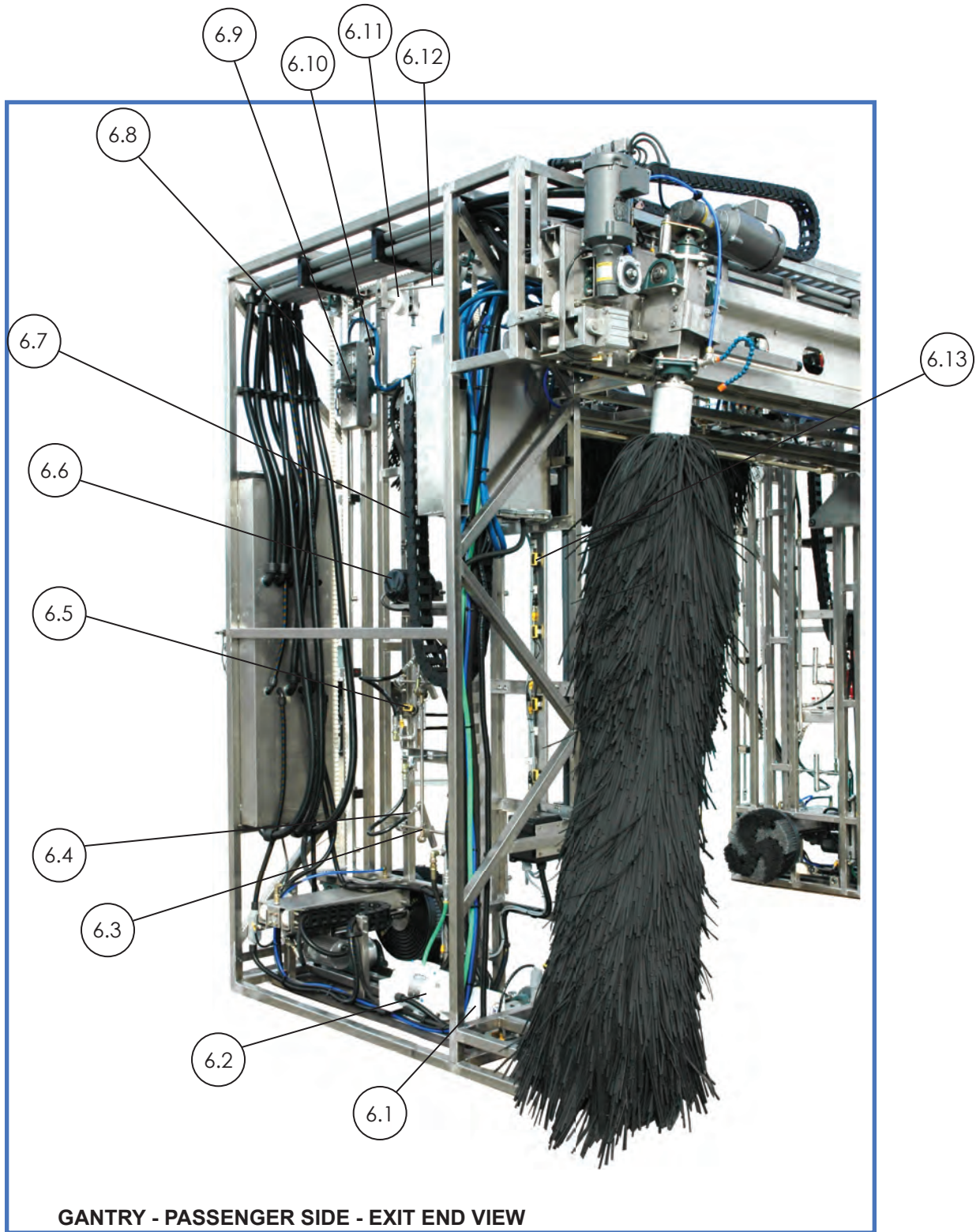

GANTRY – PASSENGER SIDE – EXIT END VIEW

ID#	PART#	DESCRIPTION
6.1	55225-1	Gear Box Lf-918, 30:1 Washdown
6.2	55230-2	.5Hp, 3/60, Inv Dty, Washdown
6.3	06838	Rod End-7/16"
6.4	22-00007	Hose, 3/8" Plastic X 24"
6.5	06711	Reciever, 8-Channel
6.6	55236-1	.13 Oscillating Motor W/Gearbx
6.7	06767	Nylatrac, 2" X 6'
6.8	18012	Belt, Timing Kevlar 50,000Mm
6.9	07512	Bearing, Flange 1.5" 2 Bolt
6.10	MS-AC55	Top Brush Rollers
6.11	MS-AC52	Belt Idler Pulley
6.12	18013	Belt, Timing Ss Endless
6.13	06711	Reciever, 8-Channel

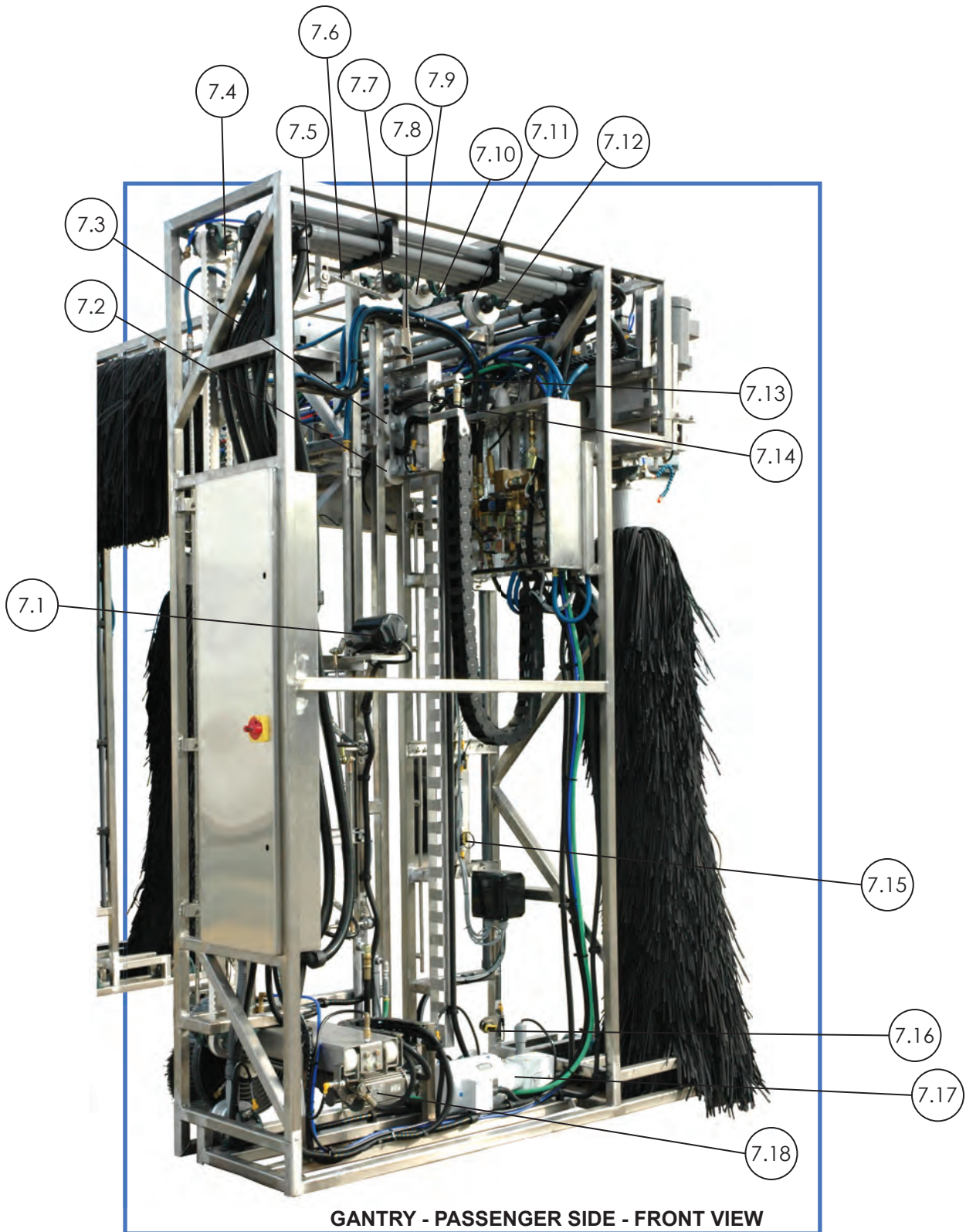

GANTRY – PASSENGER SIDE – FRONT VIEW

ID#	PART#	DESCRIPTION
7.1	55236-1	.13 Oscillating Motor W/Gearbx
7.2	MS-AC56	Roller Guide Halves
7.3	MS-AC56	Roller Guide Halves
7.4	18010	Pulley, Cog 50Mm X 94Mm
7.5	MS-AC52	Belt Idler Pulley
7.6	18013	Belt, Timing Ss Endless
7.7	18009	Pulley, Cog 25Mm X 94Mm
7.8	06852	Belt-25At10/50,000-Mk92
7.9	MS-AC53	Belt Idler Pulley
7.10	06850	Pillow Blocks-Vps-116
7.11	06605	Pulley, Boom, Alum Am002
7.12	06850	Pillow Blocks-Vps-116
7.13	74005	Swivel-1/2" X 90 Deg
7.14	06645-1	1-1/8" Poly-Hi Bearing
7.15	06711	Reciever, 8-Channel
7.16	06711	Reciever, 8-Channel
7.17	55225-1	Gear Box Lf-918, 30:1 Washdown
7.18	55000	Gear Motor, 1/3Hp 30:1 1" Hs

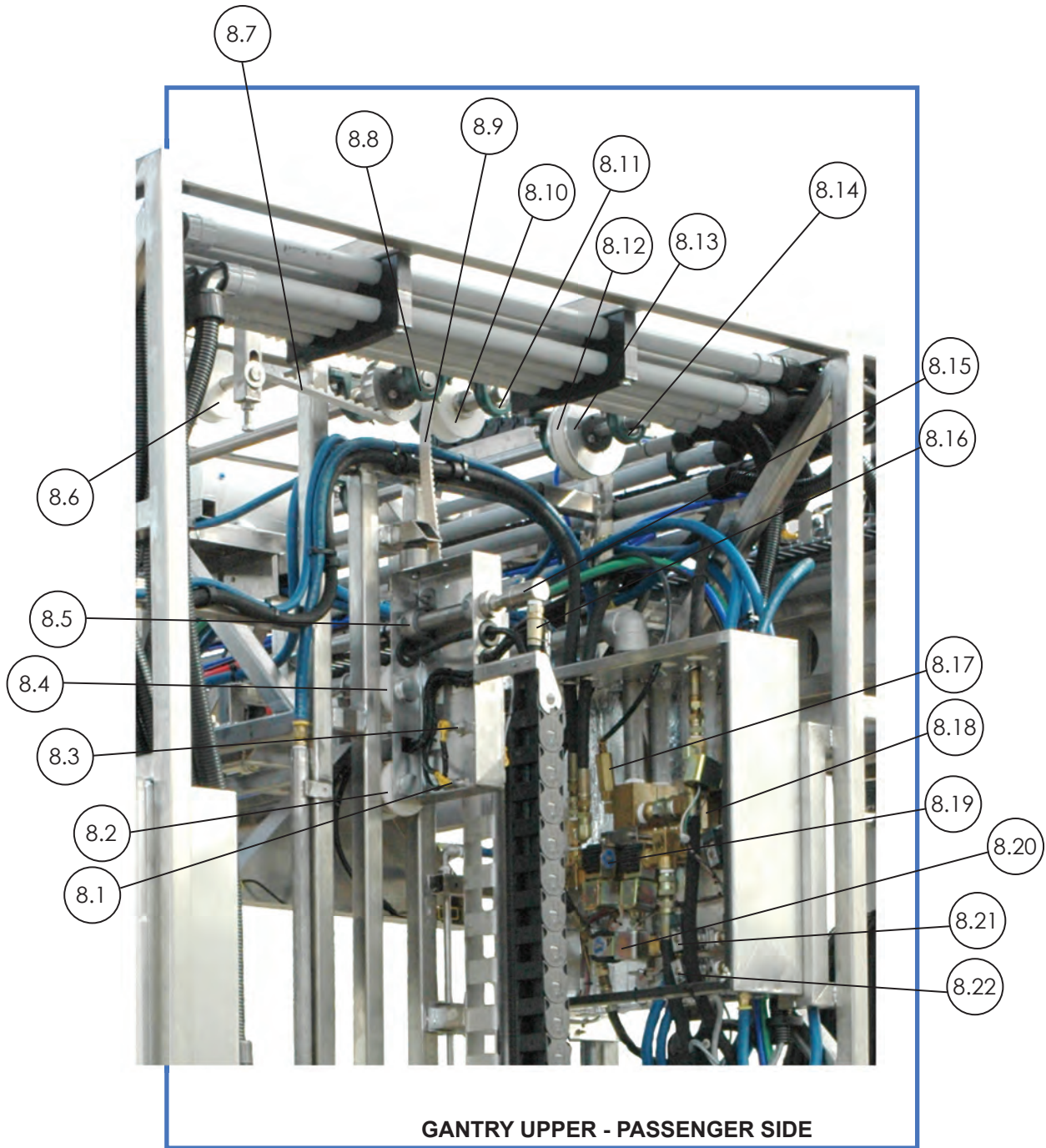

GANTRY UPPER – PASSENGER SIDE

ID#	PART#	DESCRIPTION
8.1	06626	Truck Prox Dc 18Mm
8.2	MS-AC56	Guide Roller Halves
8.3	06626	Truck Prox Dc 18Mm
8.4	MS-AC56	Guide Roller Halves
8.5	06645-1	1-1/8" Poly-Hi Bearing
8.6	MS-AC52	Belt Idler Pulley
8.7	18013	Belt, Timing Ss Endless
8.8	06850	Pillow Blocks-Vps-116
8.9	06852	Belt-25At10/50,000-Mk92
8.10	MS-AC53	Belt Idler Pulley
8.11	06850	Pillow Blocks-Vps-116
8.12	06852	Belt-25At10/50,000-Mk92
8.13	06605	Pulley, Boom, Alum Am002
8.14	06850	Pillow Blocks-Vps-116
8.15	74005	Swivel-1/2" X 90 Deg
8.16	52820	Hose, 1/2" W/B X 87", 1/2M-1/2M
8.17	34000	Check Valve, Brass Super-1/4"
8.18	31040	Dema Valve-458P 24V 1"
8.19	31030	Dema Valve-454P 24V 1/2"
8.20	31030	Dema Valve-454P 24V 1/2"
8.21	06520	Solenoid Valve, 1/2", 24Vac
8.22	06520	Solenoid Valve, 1/2", 24Vac

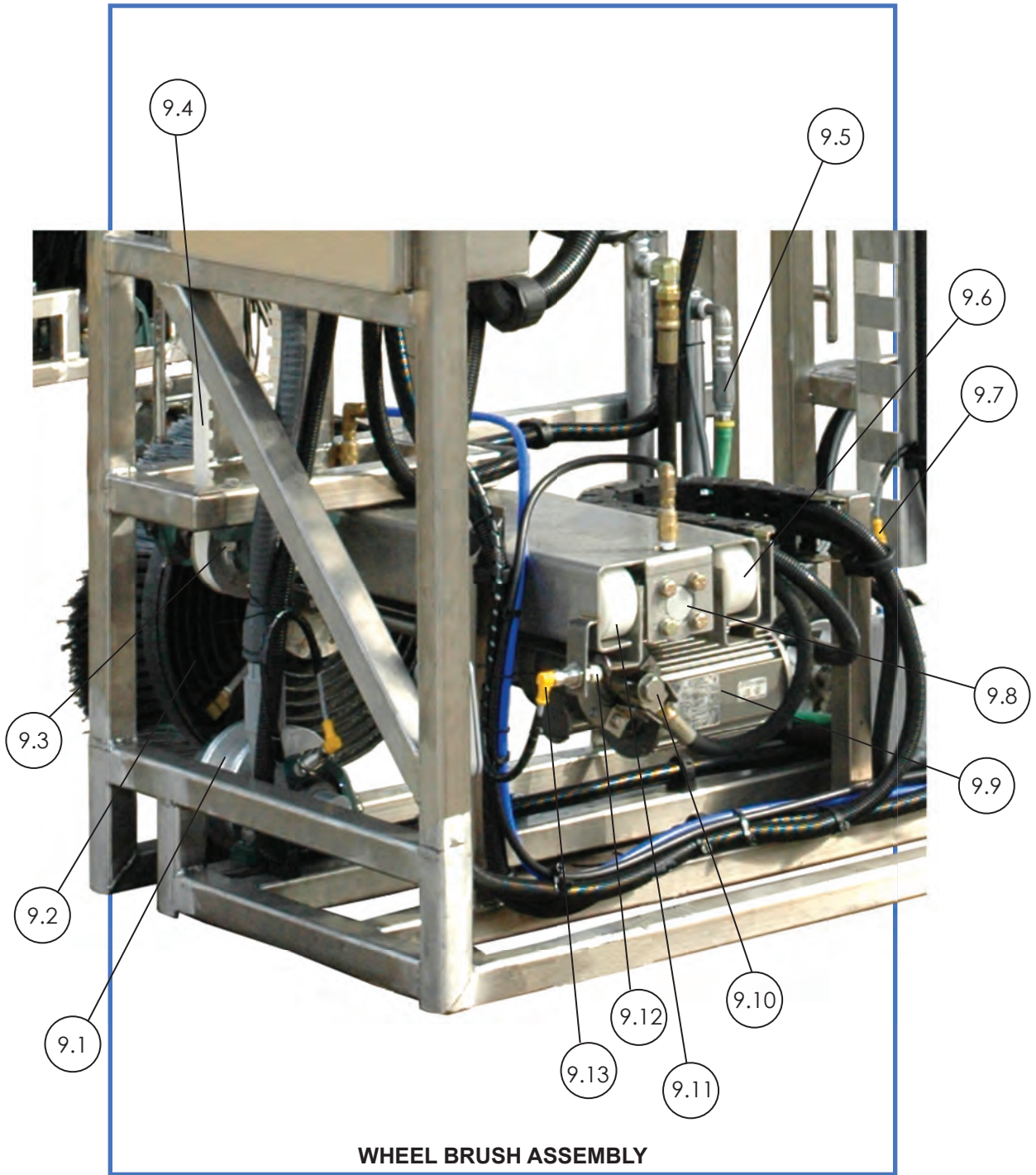

GANTRY – WHEEL BRUSH ASSEMBLY

ID#	PART#	DESCRIPTION
9.1	06500-W	Wheel, Drive
9.2	07519	Wheel Brush, Silver/Black
9.3	18009	Pulley, Cog 25Mm X 94Mm
9.4	18012	Belt, Timing Kevlar 50,000Mm
9.5	34025	Check Valve-Poly 1/4"
9.6	MS-AC54	Slide Rollers
9.7	06650-4	Cable Prox Rt Angle 4Mtr 90Deg
9.8	07504	Air Cyl, 2.5" Bore X 18"
9.9	55000	Gear Motor, 1/3Hp 30:1 1" Hs
9.10	74000	Swivel, 3/8" Hp M X F
9.11	MS-AC54	Slide Rollers
9.12	06626	Turck Prox Dc 18Mm
9.13	06650-12	Cable, Prox 15 Meter 90 Deg

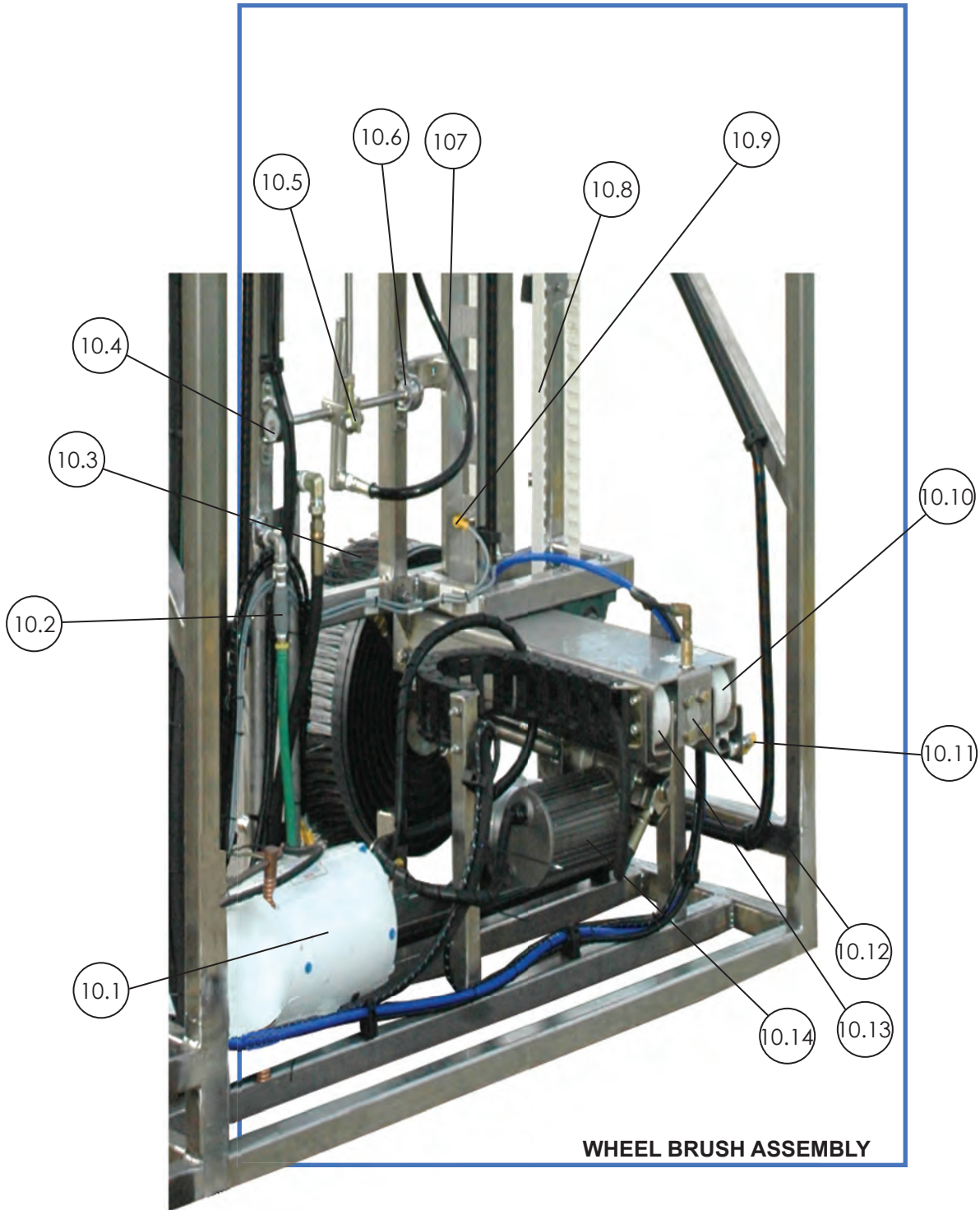

GANTRY – WHEEL BRUSH ASSEMBLY

ID#	PART#	DESCRIPTION
10.1	55230-2	.5Hp, 3/60, Inv Dty, Washdown
10.2	34025	Check Valve-Poly 1/4"
10.3	07519	Wheel Brush, Black/Silver
10.4	06647	Pillow Block Bearing - 1/2"
10.5	06838	Rod End-7/16"
10.6	06647	Pillow Block Bearing - 1/2"
10.7	22-00007	Hose, 3/8" Plastic X 24"
10.8	18012	Belt, Timing Kevlar 50,000Mm
10.9	06650-12	Cable, Prox 15 Meter 90 Deg
10.10	MS-AC54	Side Rollers
10.11	06650-4	Cable, Prox Rt. Angle 4Mtr 90Deg
10.12	07504	Air Cyl, 2.5" Bore X 18"
10.13	MS-AC54	Side Rollers
10.14	55000	Gear Motor, 1/3Hp 30:1 1" Hs

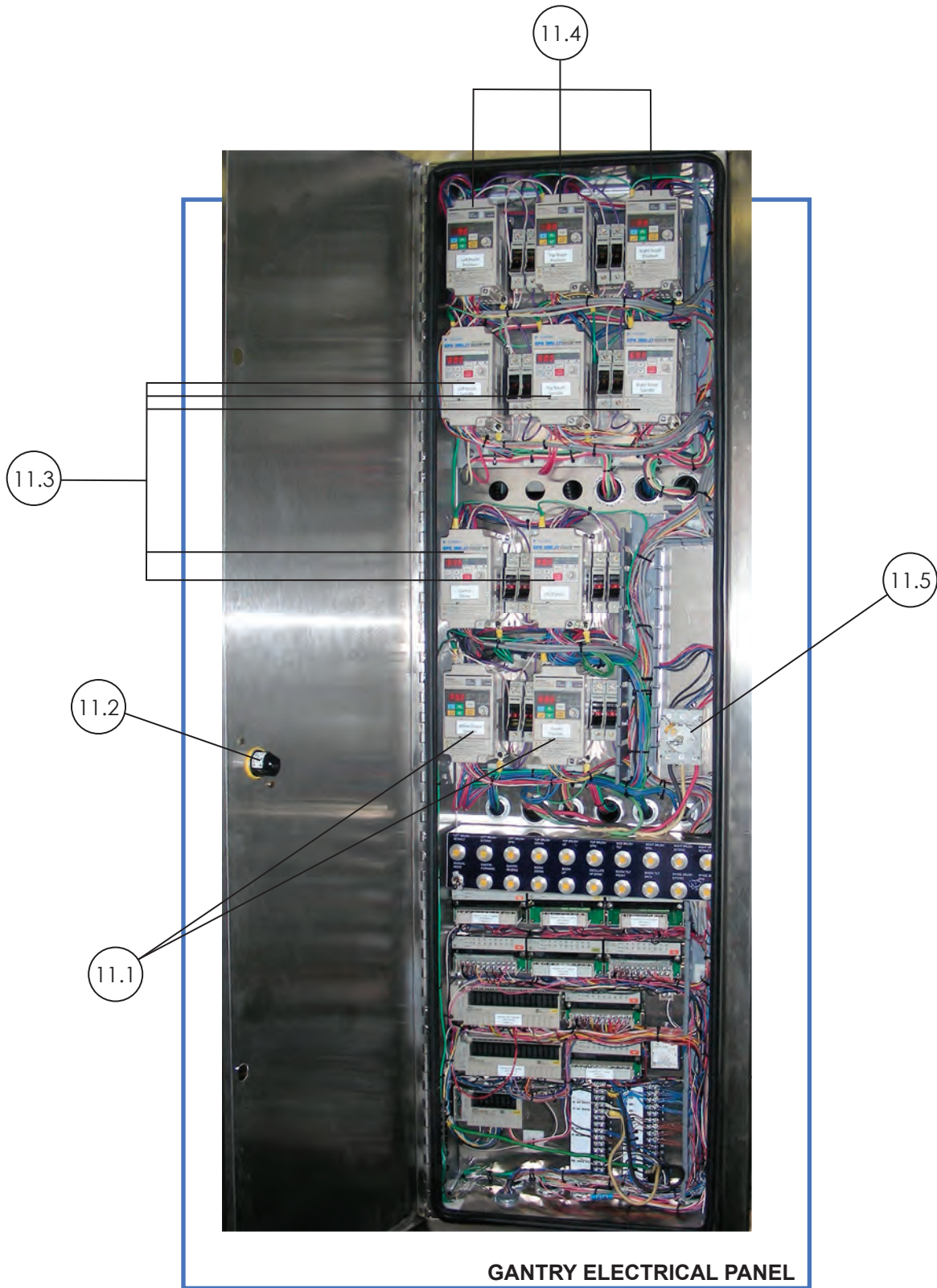

GANTRY – ELECTRICAL PANEL

ID#	PART#	DESCRIPTION
11.1	06971	Drive, 3/4Hp/230V/3Ph/50-60Hz
11.2	06997	Switch Handle Assy-Yellow/Red
11.3	06973	Drive, 1Hp/230V/5A/3Ph/50-60Hz
11.4	06971	Drive, 3/4Hp/230V/3Ph/50-60Hz
11.5	06995	63 Amp Disconnect Base Mount

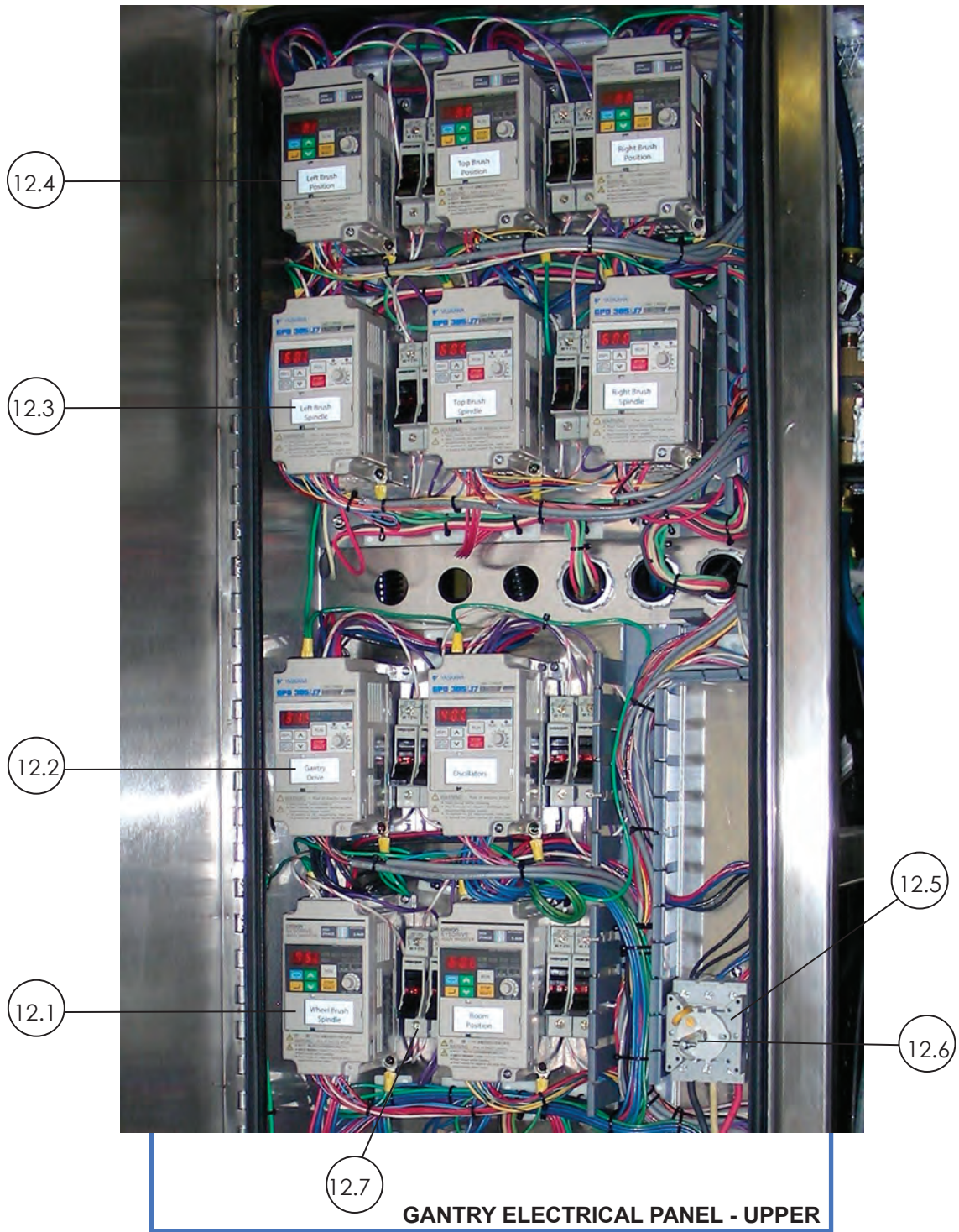

GANTRY ELECTRICAL PANEL - UPPER

ID#	PART#	DESCRIPTION
12.1	06971	Drive, 3/4Hp/230V/3Ph/50-60Hz
12.2	06973	Drive, 1Hp/230V/5A/3Ph/50-60Hz
12.3	06973	Drive, 1Hp/230V/5A/3Ph/50-60Hz
12.4	06971	Drive, 3/4Hp/230V/3Ph/50-60Hz
12.5	06995	63 Amp Disconnect Base Mount
12.6	06919	Bracket, Shaft Extension
12.7	40112-30 40032-6	Terminal Block, DI10/17.5Sf Fuse, Midget, 600V

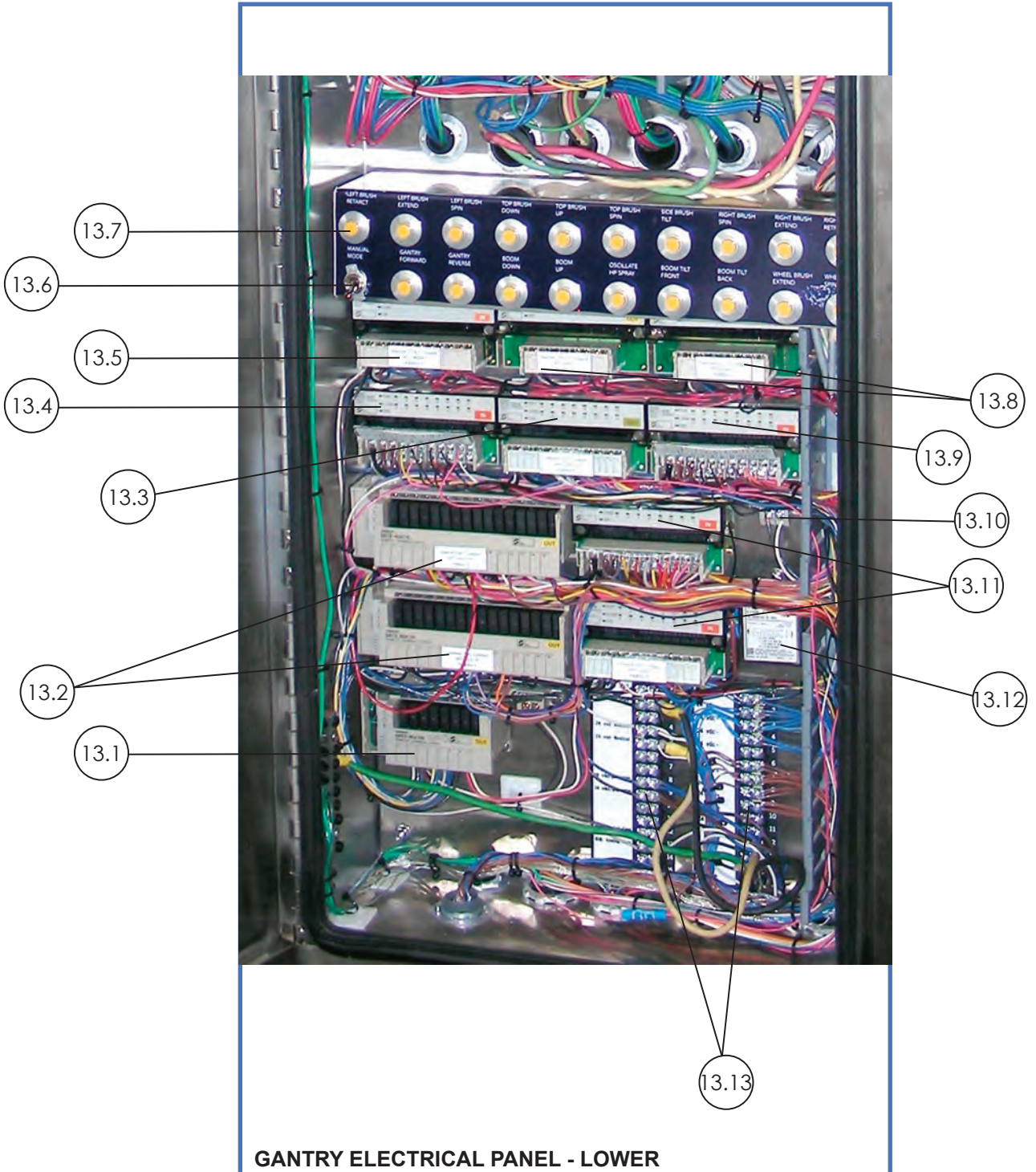

GANTRY ELECTRICAL PANEL - LOWER

ID#	PART#	DESCRIPTION
13.1	06935	Relay Output Card-Srt1 Roc08
13.2	06940	Relay Output Card-Ww Srt2Roc16
13.3	07526	Transistor Output Card
13.4	06920	Input Card-Ww Srt2-Id16
13.5	07524	Analog Input Card
13.6	40069	Switch, Spst (On-Off) 15A/120
13.7	72026	Pushbutton, Yellow
13.8	07525	Analog Output Card
13.9	06920	Input Card-Ww Srt2-Id16
13.10	06950	Resistor, Termination-Ww Drs1-Tdrs1-T
13.11	06920	Input Card-Ww Srt2-Id16
13.12	06785	Filter-3Vk3
13.13	40010-2	Terminal Strip, 15 Pt

sparkleSOFT

TOP BRUSH WITH 25 UNICA SECTIONS

Unica K121 - 18 ways 50%

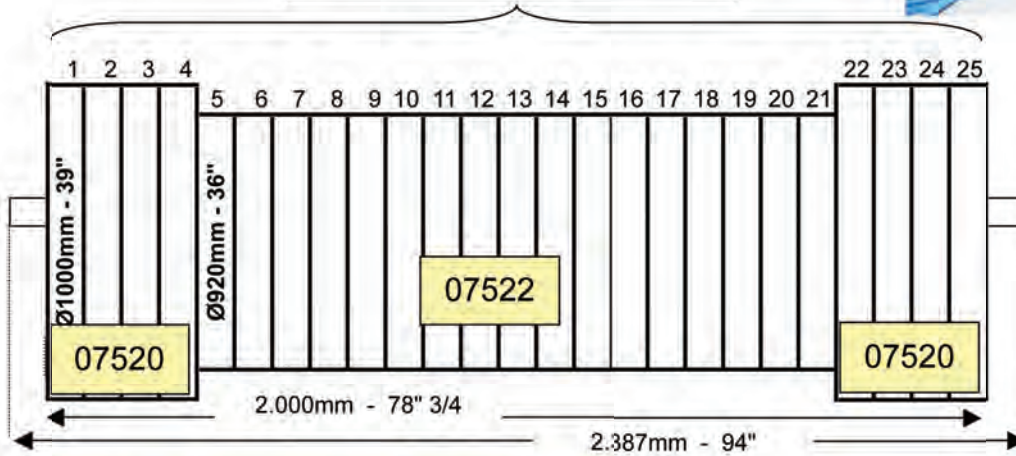

SIDE BRUSH WITH 22 UNICA SECTIONS

*JCC
Part Numbers

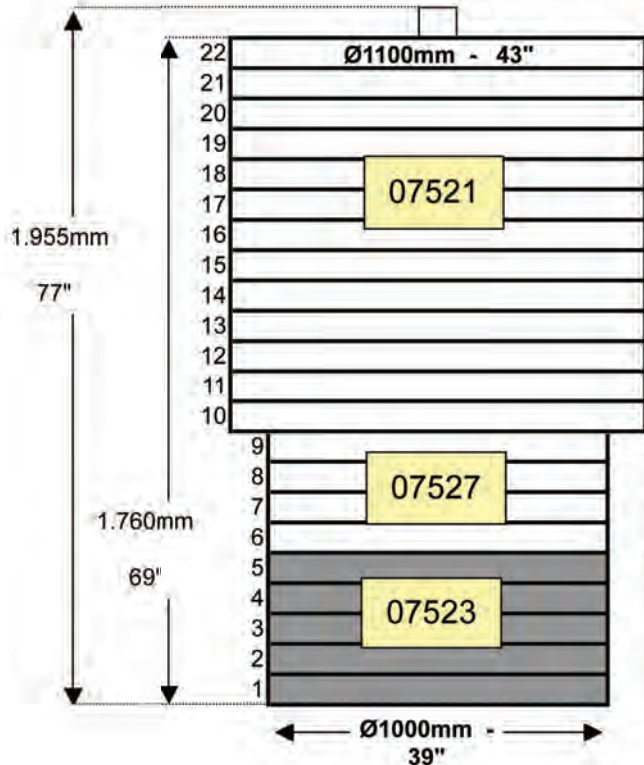

Unica K121
18 ways 50%



Unica K121
12 ways
100%



MIX
Unica K121
18 ways
Textile+Foam



pumpstand







FUSIONX PUMPSTAND

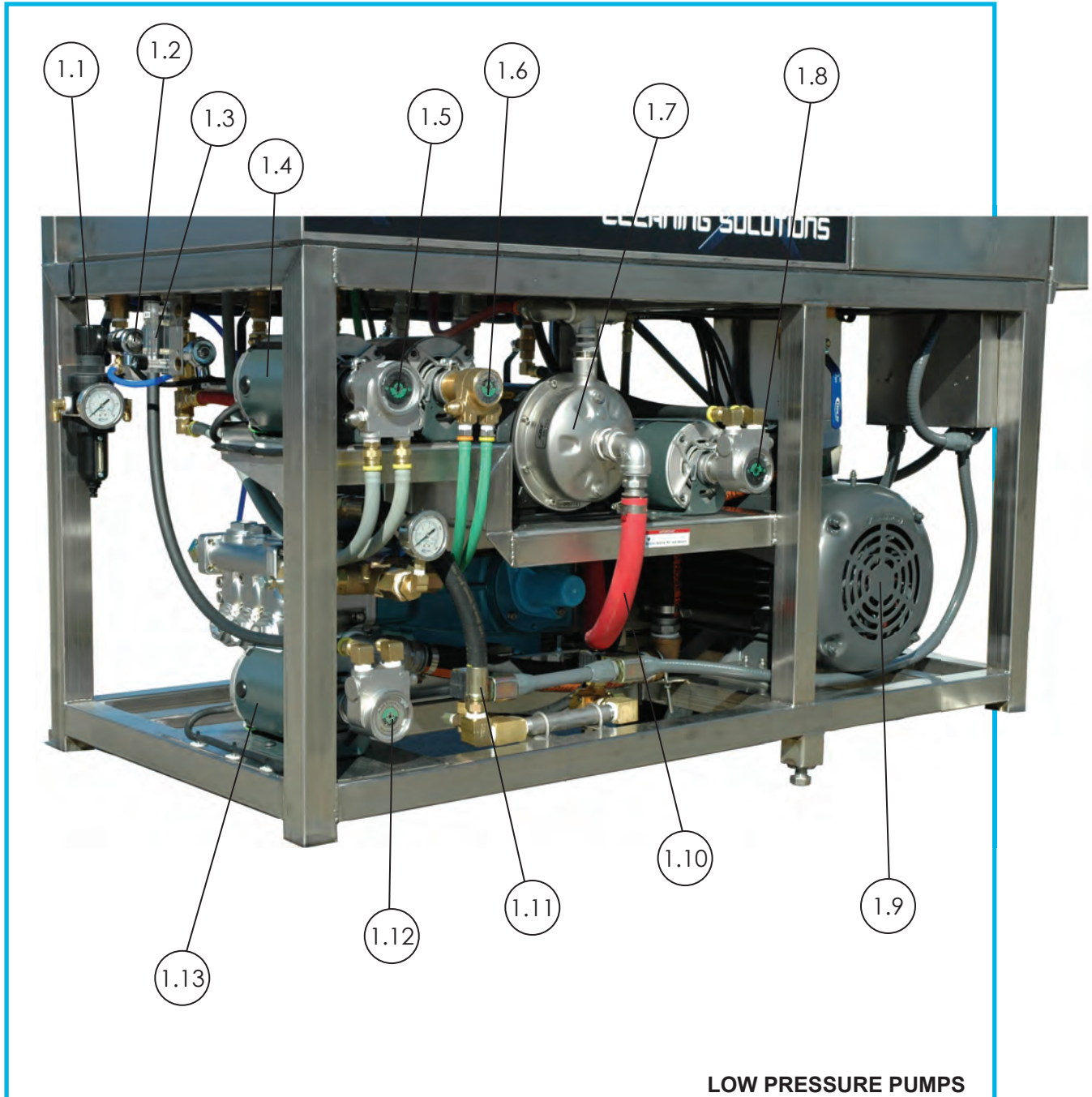

PUMP STAND – LOW PRESSURE PUMPS

ID#	PART#	DESCRIPTION
1.1	58090-1	Regulator-1/2" Parker
1.2	64071	3Bd7 Sol Valve 0-150 1/4" Ss
1.3	47075	Flow Meter, 4-40 Gpm
1.4	55016	Motor, 1/2 Hp, 1Ph
1.5	57007	Pump, 240Gph, 1/2Hp, S.S.
1.6	57002	Pump, 100Gph, 1/3Hp, Brass
1.7	32-3k133mt3	Pump, 2Hp/3Ph
1.8	57007	Pump, 240Gph, 1/2Hp, S.S.
1.9	55267	Motor 25Hp 1760 3Ph
1.10	52022	Hose-1" Push-Lok-Red Air/Water
1.11	52186	3/4" Wire Braid Hose (Undercarriage inlet)
1.12	57007	Pump, 240Gph, 1/2Hp, S.S.
1.13	55016	Motor, 1/2 Hp, 1 Ph

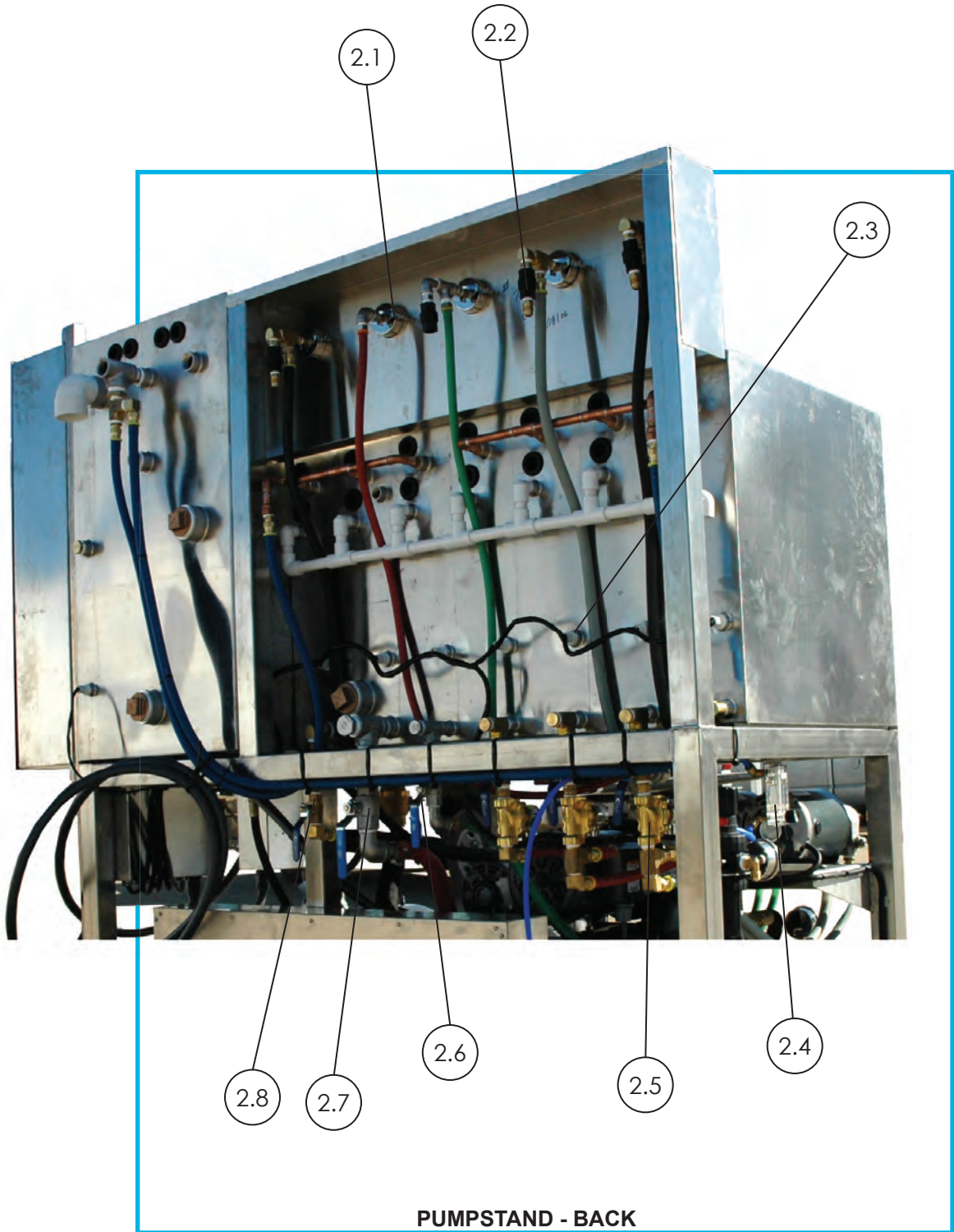

PUMPSTAND - BACK

ID#	PART#	DESCRIPTION
2.1	47010	Gauge and Bracket-Pressure 0-300 Panel
2.2	34020	Check Valve, Poly 3/8"
2.3	72050	Switch-Level (Side Mount)
2.4	47075	Flow Meter, 4-40 Gpm
2.5	64070	Solenoid-1/2Npt N.C. 24V
2.6	22450	Valve, Ball-1/2", 1000Psi
2.7	22101	Valve, Ball, 1", Full Port
2.8	22-V500P-8	Ball Valve-1/2" Brass

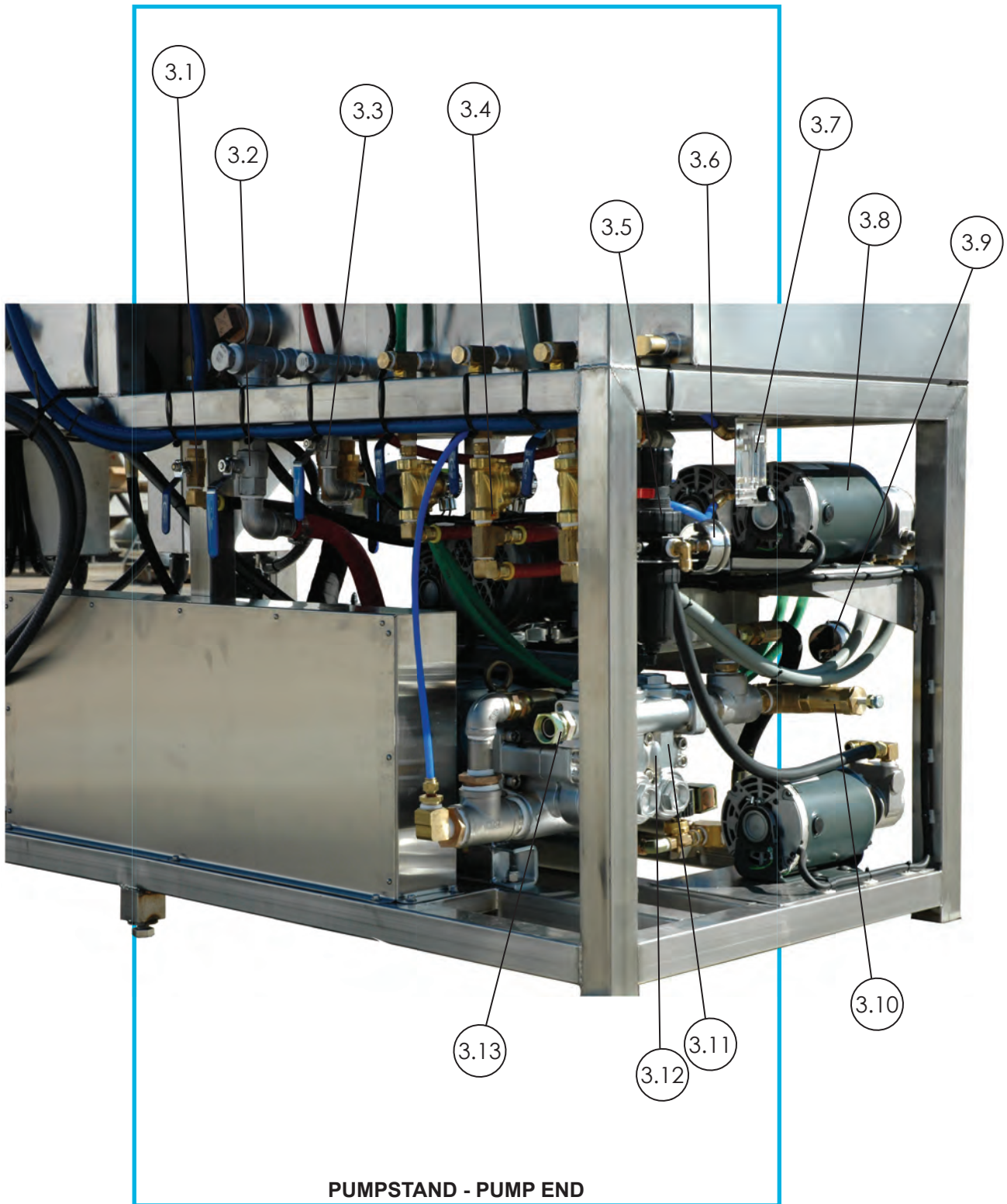

PUMPSTAND – PUMP END

ID#	PART#	DESCRIPTION
3.1	22-V500P-8	Ball Valve-1/2" Brass
3.2	22101	Valve, Ball, 1", Full Port
3.3	22450	Valve, Ball-1/2", 1000Psi
3.4	64070	Solenoid-1/2Npt N.C. 24V
3.5	58090-1	Regulator-1/2" Parker
3.6	47010	Gauge-Pressure 0-300 Panel Mt
3.7	47075	Flow Meter, 4-40 Gpm
3.8	55016	Motor, 1/2 Hp, 1 Ph
3.9	47011	Gauge-Pressure 0-300 Stem Mt
3.10	06760	Unloader-1"
3.11	32-3535	Cat 3535-35Pfr Pump 36Gpm
3.12	32-3535	Cat 3535-35Pfr Pump 36Gpm
3.13	22-0107-16-16	1"M To Female Pipe Swivel

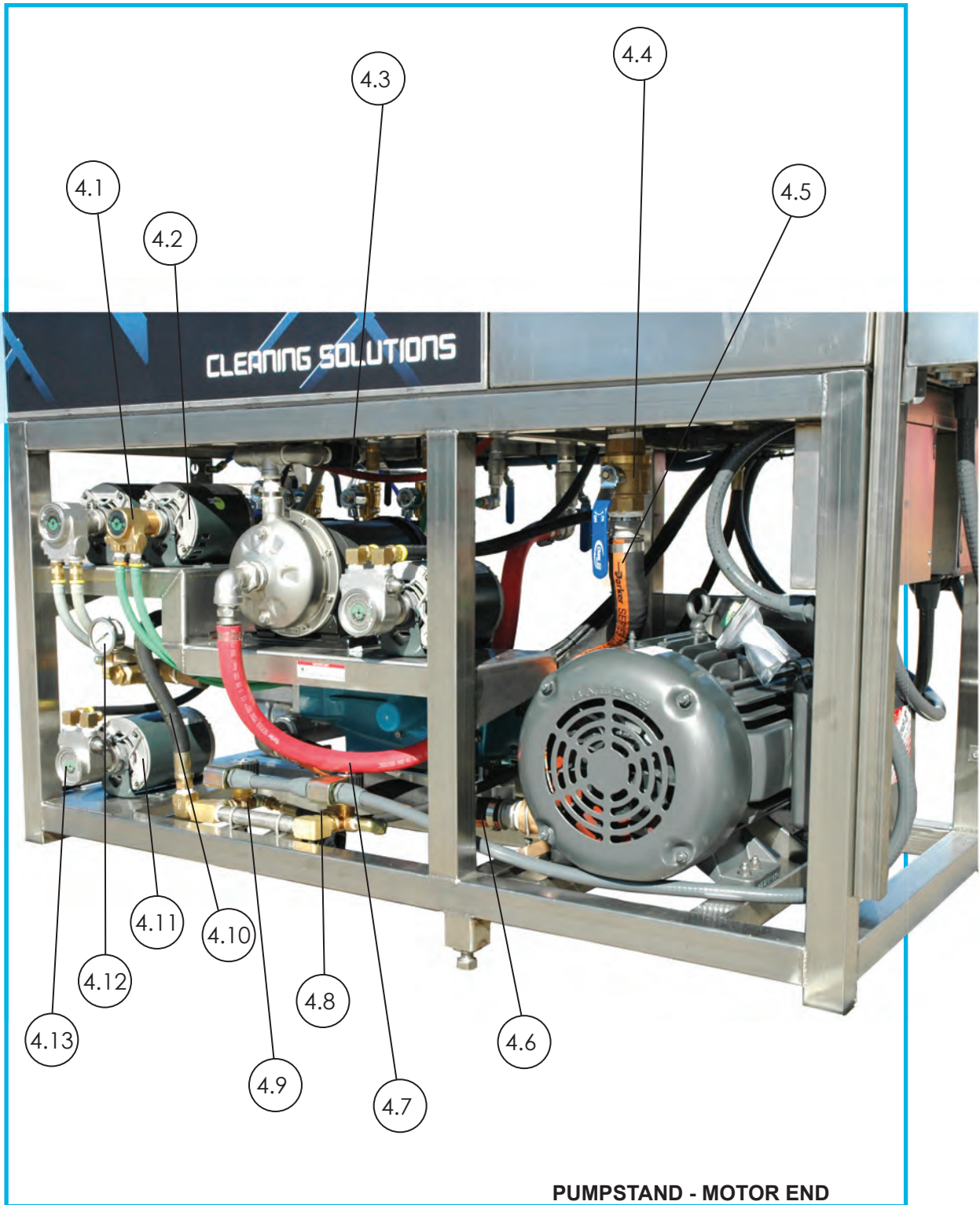

PUMPSTAND - MOTOR END

PUMPSTAND – MOTOR END

ID#	PART#	DESCRIPTION
4.1	57002	Pump, 100Gph, 1/3Hp, Brass
4.2	55013	Motor, 1/3 Hp, 1Ph
4.3	22-421-8	1/2" Wire Braid Hose Sae (52017)
4.4	22-V500P-24	Ball Valve-1-1/2"
4.5	52021	Hose, Suction, 1 1/2"
4.6	52021	Hose, Suction, 1 1/2"
4.7	22-801-16-R	Push Lock Hose-1"Red Air/Water
4.8	31030	Dema Valve-454P 24V 1/2"
4.9	31020	Dema Valve-453P 24V 3/8"
4.10	52816	Male Pipe Each End J 412 X 19"
4.11	55016	Motor, 1/2 Hp, 1 Ph
4.12	47020	Gauge-Pressure 0-2000Psi L/Mnt
4.13	57007	Pump, 240Gph, 1/2Hp, S.S.



CONTROL PANEL

PUMPSTAND – CONTROL PANEL

ID#	PART#	DESCRIPTION
5.1	72026	Pushbutton, Yellow
5.2	06681	Op. Interface, 128 X 64 - Red Lion
5.3	06997	Switch Handle Assy-Yellow/Red
5.4	24385	Cam Lock 2 Pos W/1Key,Nut,Wshr

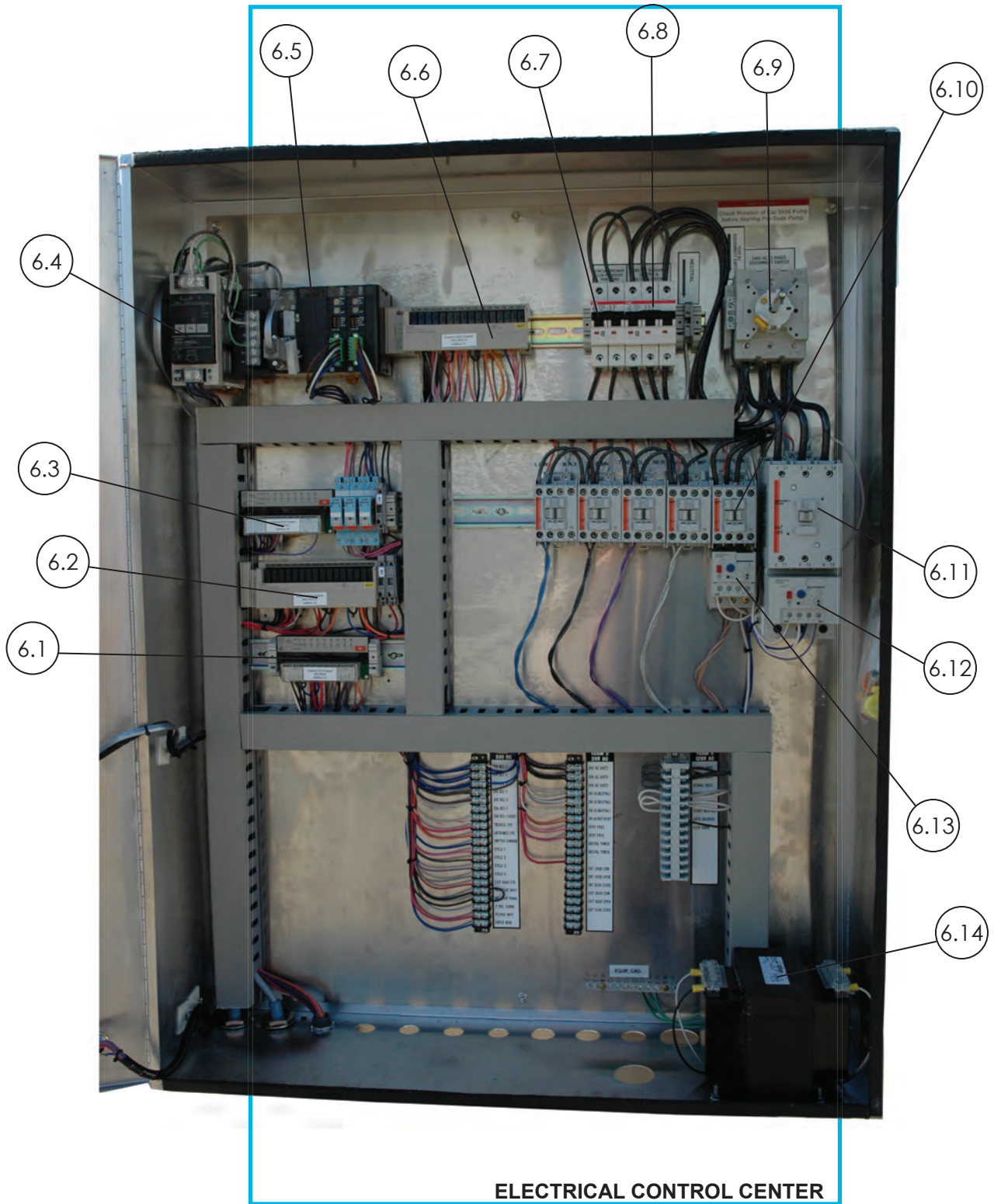

PUMPSTAND – ELECTRICAL CONTROL CENTER

ID#	PART#	DESCRIPTION
6.1	06920	Input Card-Ww Srt2-Id16
6.2	06940	Relay Output Card-Ww Srt2Roc16
6.3	06920	Input Card-Ww Srt2-Id16
6.4	06960	DC Power Supply-Omron
6.5	07503	Cpu (Fusion)
6.6	06940	Relay Output Card-Ww Srt2Roc16
6.7	40074	2P 16A Breaker UI489
6.8	40027	3P 20A Breaker UI489
6.9	06919-1	Shaft, Eec Operator
6.10	60056	Contactora, 16Amp 4Pole Ss
6.11	60065	Contactora, 85 Amp, 4 Pole 120V
6.12	60066-1	Overload, 18 - 90Amp
6.13	60062-1	Overload, 3.2 - 16Amp
6.14	40190-5	Transformer 500Va 120/240-24V

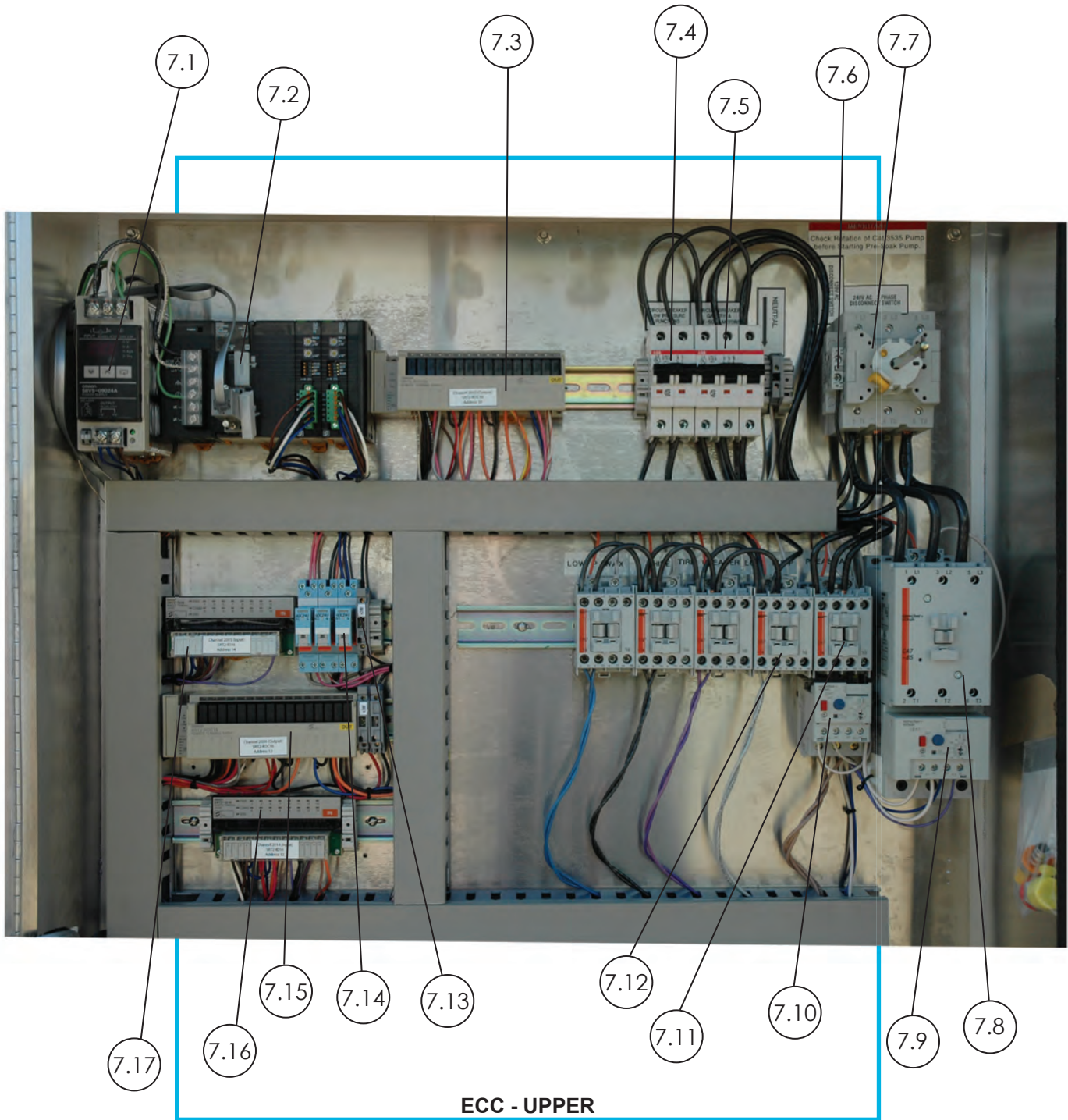

PUMPSTAND – ECC - UPPER

ID#	PART#	DESCRIPTION
7.1	06960	DC Power Supply-Omron
7.2	07503	Cpu (Fusion)
7.3	06940	Relay Output Card-Ww Srt2Roc16
7.4	40074	2P 16A Breaker UI489
7.5	40027	3P 20A Breaker UI489
7.6	06996	Aux Relay Contacts
7.7	06994	100 Amp Disconnect Base Mount
7.8	60065	Contactor, 85 Amp, 4 Pole 120V
7.9	60066-1	Overload, 18 - 90Amp
7.10	60062-1	Overload, 3.2 - 16Amp
7.11	60056	Contactor, 16Amp 4Pole Ss
7.12	60056	Contactor, 16Amp 4Pole Ss
7.13	40032-2	Fuse, Glass 10A 250V
7.14	06948	Relay, 24 Vadc-Ac/Dc Coil
7.15	06940	Relay Output Card-Ww Srt2Roc16
7.16	06920	Input Card-Ww Srt2-Id16
7.17	06920	Input Card-Ww Srt2-Id16

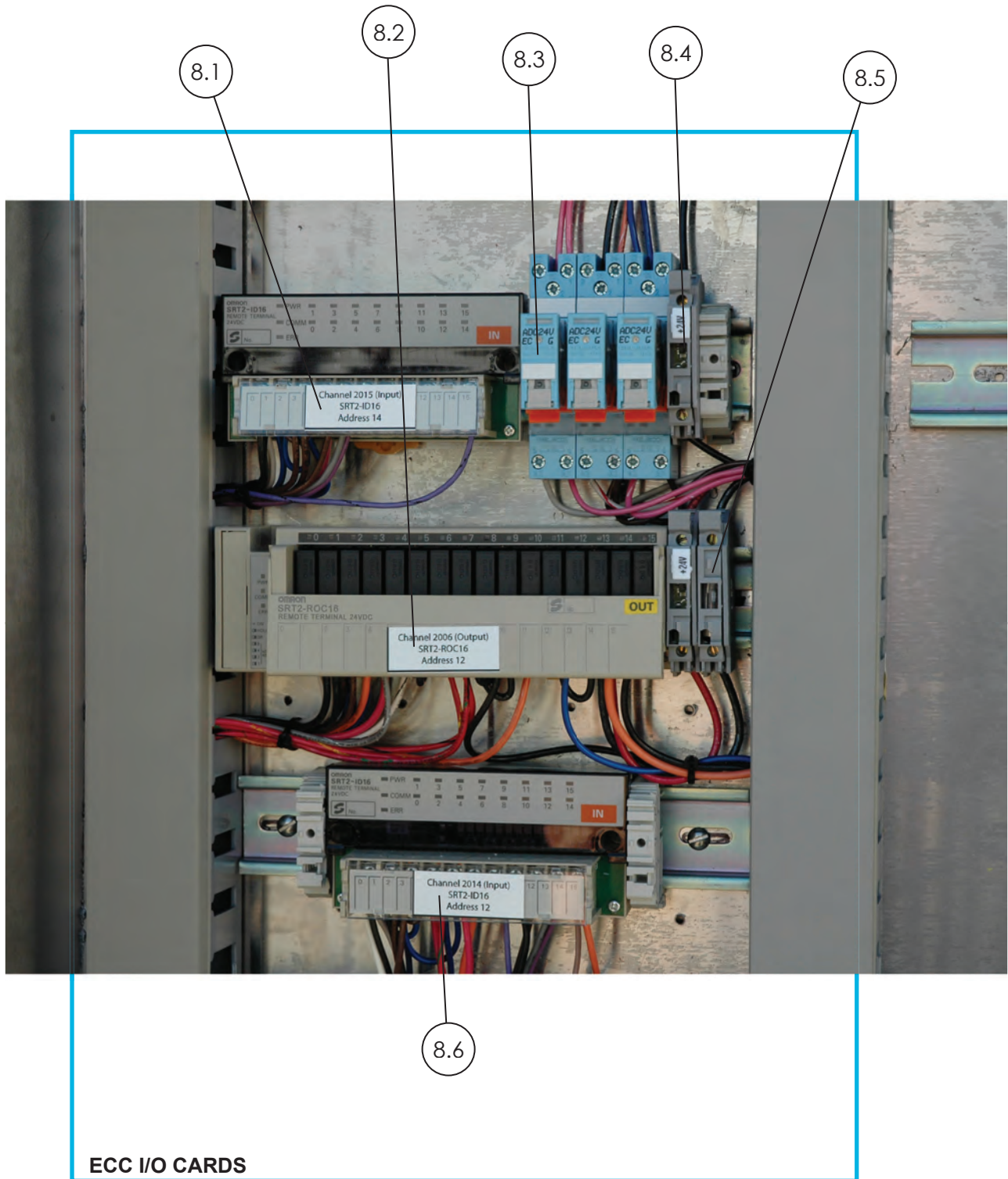

PUMPSTAND – ECC – I/O CARDS

ID#	PART#	DESCRIPTION
8.1	06920	Input Card-Ww Srt2-Id16
8.2	06940	Relay Output Card-Ww Srt2Roc16
8.3	06948	Relay, 24 Vadc-Ac/Dc Coil
8.4	40340-2 40032-2	Block, Terminal Fusehldr 24V 10 Amp Fuse
8.5	40340-1 40032-3	Block, Terminal Fusehldr 120V 3 Amp Fuse
8.6	06920	Input Card-Ww Srt2-Id16

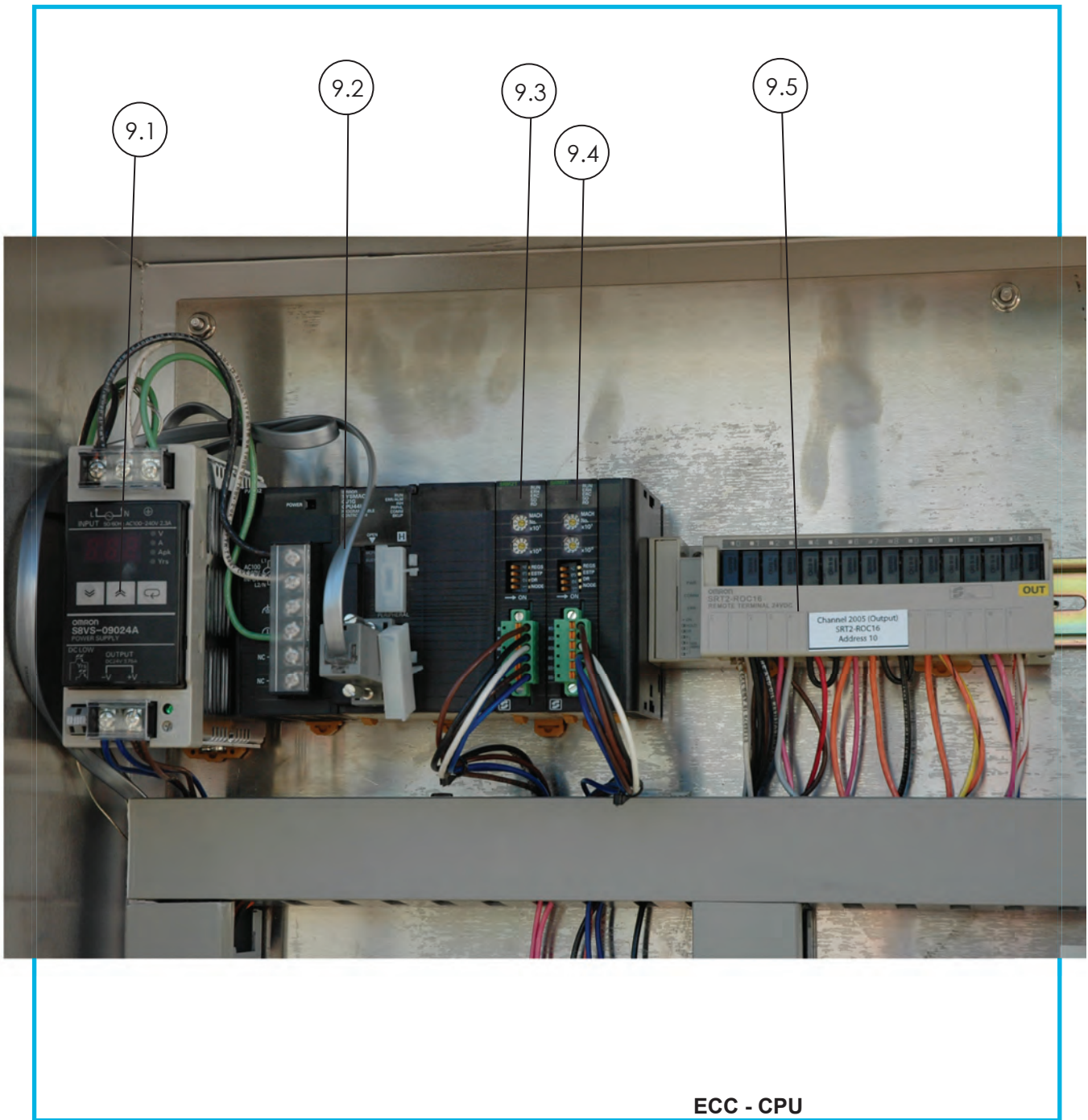

PUMP STAND – ECC – CPU

ID#	PART#	DESCRIPTION
9.1	06960	Power Supply-Omron
9.2	06508	Cable, Red Lion to Computer
9.3	06680-2	Cj1 - Compobus/S - Master
9.4	06680-2	Cj1 - Compobus/S - Master
9.5	06940	Relay Output Card-Ww Srt2Roc16

NOTES
